

▶ 2025







# Surfaces Collection

ENERGIEKER



# General index

Indice generale. Index général. Allgemeiner Index.

-  **Product indexes** ☐  
Indici prodotti. Index de produits. Produktindizes.
-  **The Company** ☐  
L'Azienda. L'Entreprise. Das Unternehmen.
-  **Collections** ☐  
Collezioni. Collections. Kollektionen.
  - Marble Look** ☐
  - Concrete Look** ☐
  - Stone Look** ☐
  - Metal Look** ☐
  - Wood Look** ☐
  - Cotto Look** ☐
-  **TH2.0 Outdoor Solutions** ☐  
Collezioni outdoor. Collections d'extérieur.  
Outdoor-Kollektionen.
-  **Bathroom furniture** ☐  
Arredo bagno. Mobilier de salle de bain. Badezimmermöbel.
-  **Ventilated facades** ☐  
Facciate ventilate. Façades ventilées. Hinterlüftete Fassade.
-  **Technical information** ☐  
Informazioni tecniche. Informations techniques.  
Technische Informationen.



# Index A - Z

Indice A - Z. Index A - Z. Alphabetisches Verzeichnis.

## A

Agathòs  
Agathòs TH2.0  
Agatina Blue  
Alaska  
Amani  
Amazzonite  
Ambre Cloud  
Antichi Amori  
Antiqua

## B

Basaltina TH2.0  
Bernini  
Botanic Blue  
Brera  
Brera TH2.0  
Bright Precious

## C

Calacatta  
Calacatta TH2.0  
Calacatta Cenerino  
Calacatta Oceanic  
Calacatta Splendido  
Calacatta Viola  
Campigiane  
Cardosia  
Carrara Gioia  
Cashmere  
Cementine  
Ceppo di Grè  
Ceppo di Grè TH2.0  
City Plaster  
Concept  
Corsocomo  
Crystal Sea

## D

Dolomite  
Dubai Gold

## E

Emerald Paris  
Eternal Blue  
Explosion

## F

Fitch  
Flatiron  
Flatiron TH2.0

## G

Genesis  
Genesis TH2.0

## H

H24  
Heritage  
Heritage TH2.0  
Hollstone  
Hollstone TH2.0

## I

Invisible Grey

## L

Levante  
Lincoln  
Loft  
Loft TH2.0  
Loop  
Loop TH2.0

## M

Magnetic  
Magnetic TH2.0  
Maioliche  
Makrana  
Marquiña  
Massive  
Medley  
Medley TH2.0  
Montecchio  
Mood

## N

Navona  
Navona TH2.0  
Nereidi  
Nereidi TH2.0

## O

Onyx  
Oxidatio

## P

Padouk  
Padouk TH2.0  
Parker  
Parker TH2.0  
Patagonia  
Pennslate  
Pennslate TH2.0  
Pierre Black  
Pietra Di Vals  
Pietra Di Vals TH2.0  
Pietragrey

## Q

Quarzi

## R

Res-Terrae  
Robur  
Robur TH2.0  
Royal Sodalite  
Rushmore  
Rushmore TH2.0

## S

Sahara Noir  
Saint Laurent  
Sarancollin  
Select  
Spark  
Spark TH2.0  
Statuario Superiore  
Sunstone  
Sunstone TH2.0

## T

Taj Mahal  
Tempest Dedalus

## U

Unicolors  
Urano  
Urano TH2.0  
Utah

## V

Verde Alpi

## W

Wallart  
Warm Ambrosia  
White Beauty  
Wonder  
Wonder TH2.0  
Woodbreak  
Woodbreak TH2.0  
Woodwise



WALL Levante 120x280 . 48"x110"  
FURNITURE Taj Mahal Amber 120x280 . 48"x110"  
FLOOR Taj Mahal Amber 120x120 . 48"x48"

General  
index

Product  
indexes

Index A-Z

Indoor sizes index  
Outdoor sizes index  
Colours index



The  
Company

Collections

TH2.0  
Outdoor  
Solutions

Bathroom  
furniture

Ventilated  
facades

Technical  
information

# Indoor sizes index

Indice formati indoor. Index des formats intérieur. Index nach Format für Innenbereich.



**EKXTREME**  
**160x320** 63"x126"

Calacatta



**EKXTREME**  
**120x280** 48"x110"

Agathòs  
Agatina Blue  
Alaska  
Amani  
Amazonite  
Ambre Cloud  
Bernini  
Botanic Blue  
Brera  
Bright Precious  
Calacatta  
Calacatta Cenerino  
Calacatta Oceanic  
Calacatta Splendido  
Calacatta Viola  
Carrara Gioia  
Ceppo di Grè  
City Plaster  
Crystal Sea  
Dolomite  
Dubai Gold  
Emerald Paris  
Eternal Blue  
Explosion

Energieker

Flatiron  
Genesis  
Heritage  
Invisible Grey  
Levante  
Lincoln  
Loft  
Magnetic  
Makrana  
Marquiña  
Mood  
Navona Soft  
Navona Vein  
Nereidi  
Onyx  
Oxidatio  
Parker  
Patagonia  
Pierre Black  
Royal Sodalite  
Sahara Noir  
Saint Laurent  
Sarancollin  
Statuario Superiore  
Sunstone  
Taj Mahal  
Tempest Dedalus  
Verde Alpi  
Warm Ambrosia  
White Beauty  
Wonder  
Woodwise



**120x120** 48"x48"

Agathòs  
Alaska  
Amani  
Brera

2025 Surfaces Collection

Bright Precious  
Calacatta  
Calacatta Splendido  
Calacatta Viola  
Cardosia  
Carrara Gioia  
Ceppo di Grè  
City Plaster  
Concept  
Corsocomo  
Crystal Sea  
Dubai Gold  
Flatiron  
Genesis  
Heritage  
Hollstone  
Lincoln  
Loft  
Makrana  
Marquiña  
Massive  
Medley  
Navona Soft  
Navona Vein  
Nereidi  
Onyx  
Oxidatio  
Parker  
Patagonia  
Pierre Black  
Pietragrey  
Res-Terrae  
Sahara Noir  
Saint Laurent  
Sarancollin  
Select  
Statuario Superiore  
Sunstone  
Taj Mahal  
Warm Ambrosia  
White Beauty  
Wonder



**80x160** 32"x63"

Navona Vein  
Onyx  
Wonder



**80x80** 32"x32"

Brera  
Ceppo di Grè  
Concept  
Corsocomo  
Flatiron  
Hollstone  
Loft  
Magnetic  
Massive  
Onyx  
Parker  
Res-Terrae  
Select



**60x120** 24"x48"

Agathòs  
Agatina Blue  
Alaska  
Amani  
Amazonite  
Ambre Cloud  
Bernini  
Brera  
Bright Precious  
Calacatta  
Calacatta Cenerino

Calacatta Oceanic  
Calacatta Splendido  
Calacatta Viola  
Cardosia  
Carrara Gioia  
Cashmere  
Ceppo di Grè  
City Plaster  
Concept  
Corsocomo  
Crystal Sea  
Dolomite  
Dubai Gold  
Emerald Paris  
Eternal Blue  
Flatiron  
Genesis  
Heritage  
Hollstone  
Invisible Grey  
Levante  
Lincoln  
Loft  
Loop  
Magnetic  
Makrana  
Marquiña  
Massive  
Medley  
Mood  
Navona Soft  
Navona Vein  
Nereidi  
Onyx  
Oxidatio  
Padouk  
Parker  
Patagonia  
Pennslate  
Pierre Black  
Pietragrey  
Res-Terrae

Royal Sodalite  
Rushmore  
Sahara Noir  
Saint Laurent  
Sarancollin  
Select  
Spark  
Statuario Superiore  
Sunstone  
Taj Mahal  
Verde Alpi  
Wallart  
Warm Ambrosia  
White Beauty  
Wonder  
Woodwise



**60x60** 24"x24"

Agathòs  
Amani  
Brera  
Calacatta  
Calacatta Viola  
Cardosia  
Cashmere  
Cementine  
Ceppo di Grè  
City Plaster  
Concept  
Corsocomo  
Flatiron  
Genesis  
H24  
Heritage  
Hollstone  
Loft  
Magnetic  
Marquiña  
Massive  
Medley  
Mood  
Navona Soft  
Navona Vein  
Nereidi

Onyx  
Oxidatio  
Parker  
Pietragrey  
Res-Terrae  
Rushmore  
Saint Laurent  
Sarancollin  
Select  
Spark  
Statuario Superiore  
Sunstone  
Taj Mahal  
Verde Alpi  
Wonder



**30x60** 12"x24"  
**30,8x61,5** 12"x24"

Agathòs  
Amani  
Brera  
Calacatta Viola  
Cardosia  
Cashmere  
Cementine  
Ceppo di Grè  
City Plaster  
Corsocomo  
Dolomite  
Fitch  
Flatiron  
Genesis  
H24  
Heritage  
Loft  
Loop  
Magnetic  
Massive  
Navona Soft  
Navona Vein  
Nereidi  
Onyx  
Oxidatio  
Parker  
Pennslate

Pietra di Vals  
Rushmore  
Saint Laurent  
Select  
Statuario Superiore  
Sunstone  
Urano  
Utah  
Wonder



**30x30** 12"x12"

Antichi Amori  
Campigiane



**30x160** 12"x63"

Padouk  
Robur  
Woodbreak  
Woodwise



**20x160** 8"x63"

Padouk  
Robur  
Woodbreak



**30x120** 12"x48"

Padouk  
Robur  
Woodbreak  
Woodwise



**20x120** 8"x48"

Antiqua  
Padouk  
Robur  
Woodbreak  
Woodwise



**20x50** 8"x20"

Cementine  
H24  
Select



**20x40** 8"x16"

Pietra Di Vals  
Rushmore  
Sunstone



**20x20** 8"x8"

Maioliche  
Unicolors



**15x30** 6"x12"

Antichi Amori  
Campigiane  
Montecchio  
Pietra Di Vals  
Quarzi  
Urano



**9,9x30,2** 4"x12"

Agathòs  
Wonder

General index

Product indexes

Index A-Z  
Indoor sizes index  
Outdoor sizes index  
Colours index



The Company

Collections

TH2.0  
Outdoor  
Solutions

Bathroom  
furniture

Ventilated  
facades

Technical  
information

Indexes

# Outdoor sizes index

Indice formati outdoor. Index des formats extérieur. Index nach Format für Außenbereich.



**TH2.0**  
**120x120** 48"x48"

- Basaltina
- Ceppo di Grè
- Loft
- Loop
- Parker
- Sunstone



**TH2.0**  
**30x120** 12"x48"

- Padouk
- Robur
- Woodbreak



**TH2.0**  
**60x60** 24"x24"

- Agathòs
- Basaltina
- Brera
- Calacatta
- Ceppo di Grè
- Flatiron
- Genesis
- Heritage
- Hollstone
- Loft
- Loop
- Magnetic
- Medley
- Navona Soft
- Nereidi
- Padouk
- Parker
- Pennslate
- Pietra di Vals
- Rushmore
- Spark
- Sunstone
- Urano
- Wonder



**TH2.0**  
**60x90** 24"x36"

- Basaltina
- Navona Soft
- Navona Vein
- Pennslate
- Pietra di Vals
- Rushmore
- Sunstone
- Urano
- Wonder



**TH2.0**  
**60x120** 24"x48"

- Agathòs
- Basaltina
- Brera
- Calacatta
- Ceppo di Grè
- Flatiron
- Genesis
- Heritage
- Hollstone
- Loft
- Loop
- Magnetic
- Navona Vein
- Nereidi
- Padouk
- Parker
- Pennslate
- Pietra di Vals
- Rushmore
- Spark
- Sunstone
- Urano
- Wonder



**TH2.0**  
**80x80** 32"x32"

- Ceppo di Grè
- Flatiron
- Hollstone
- Loft
- Magnetic
- Medley
- Navona Soft
- Parker
- Pietra di Vals
- Urano



FLOOR Genesis. Storm 60x60 . 24"x24" TH2.0

General index

Product indexes

Index A-Z  
Indoor sizes index  
Outdoor sizes index  
Colours index



The Company

Collections

TH2.0  
Outdoor Solutions

Bathroom furniture

Ventilated facades

Technical information

# Marble Look

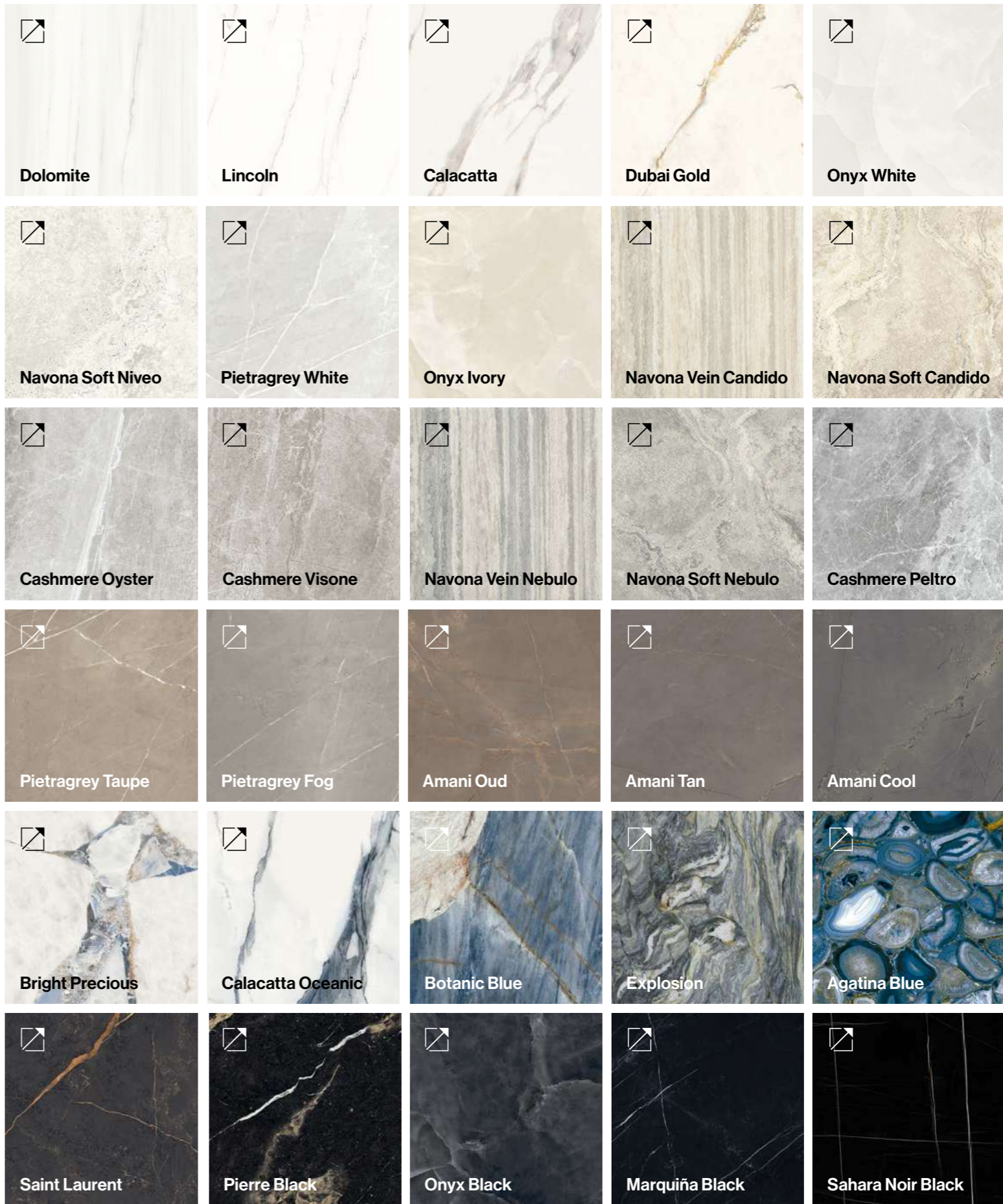
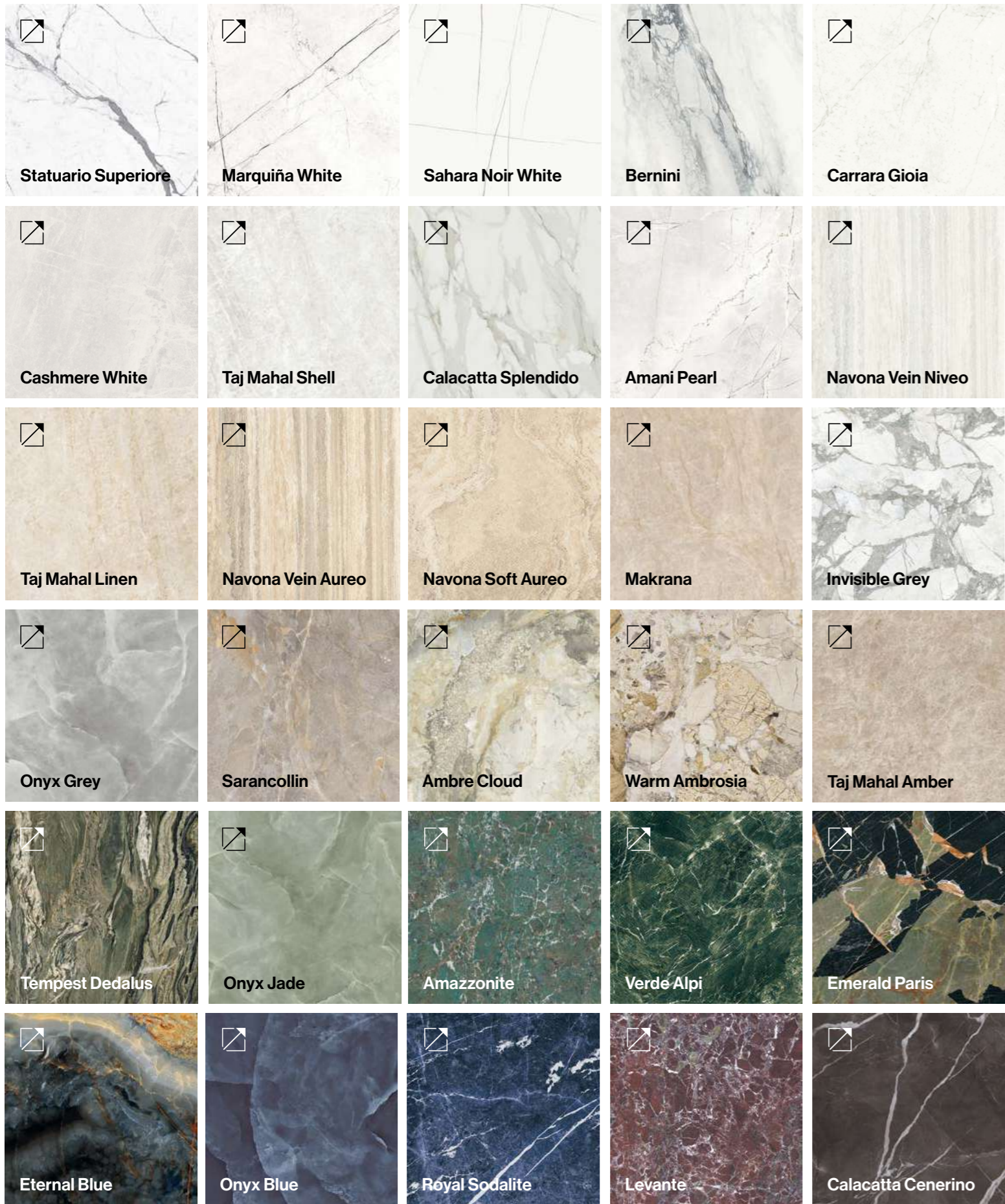

# Marble Look

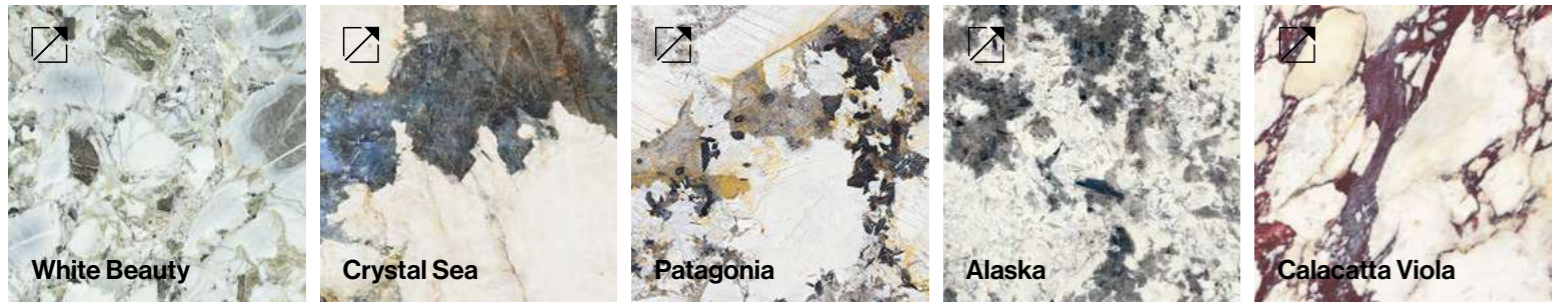

# Stone Look



# Stone Look

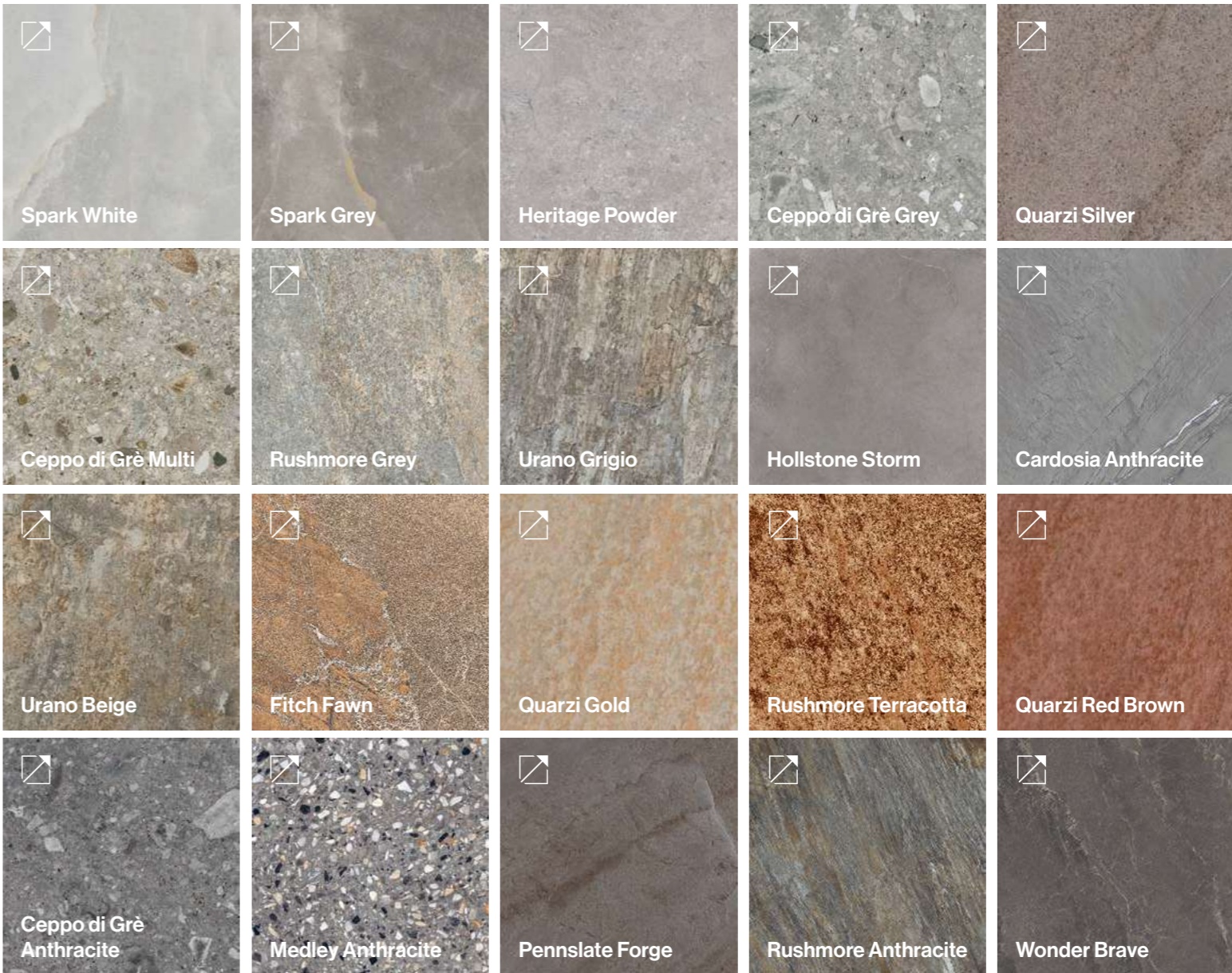
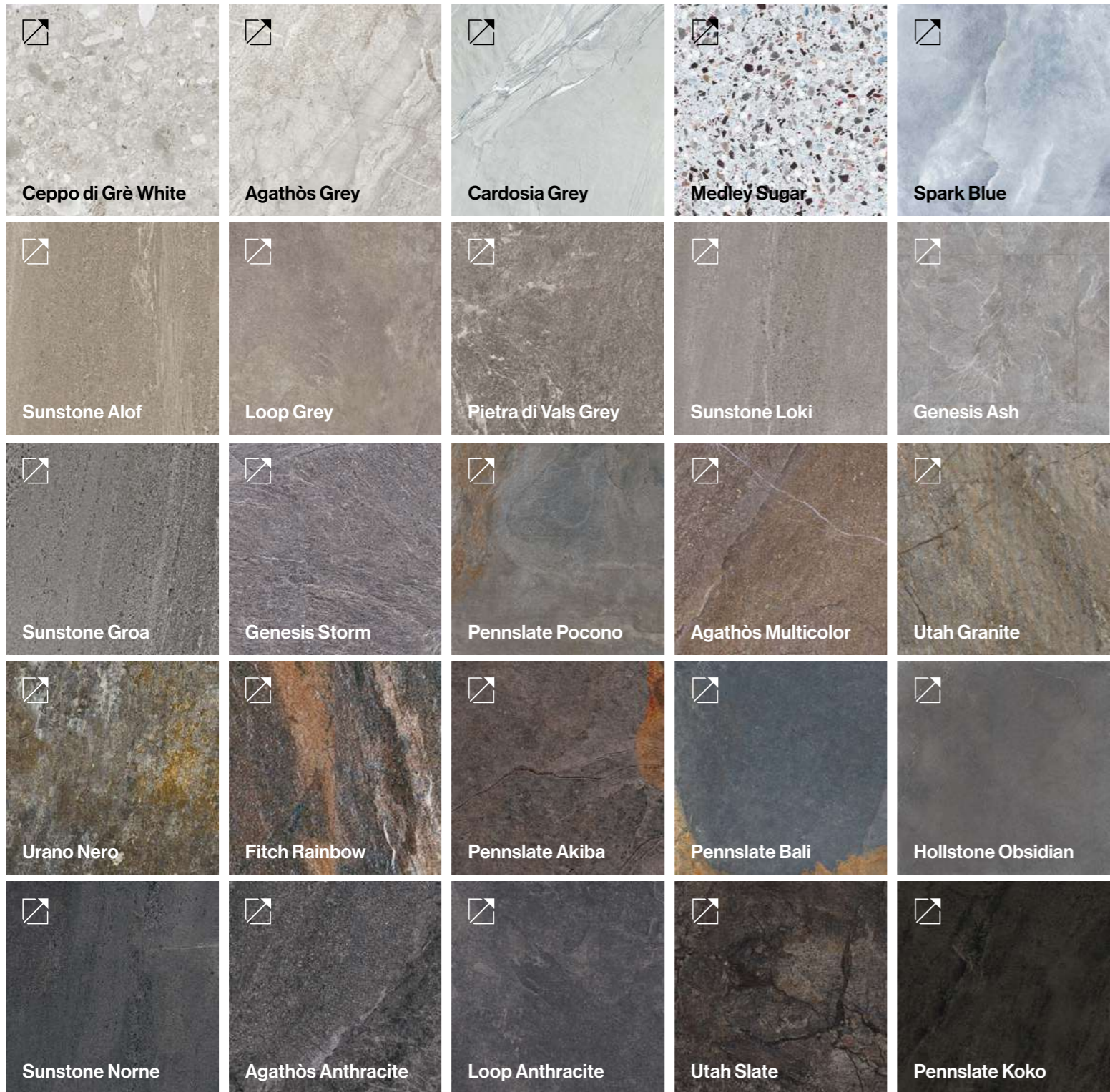

General index

**Product indexes**  
 Index A-Z  
 Indoor sizes index  
 Outdoor sizes index  
 Colours index

The Company

Collections

TH2.0 Outdoor Solutions

Bathroom furniture

Ventilated facades

Technical information



# Concrete Look

 <b>Unicolors Brillo</b>	 <b>Unicolors Tania</b>	 <b>Mood Pure</b>	 <b>Res-Terrae Cotton</b>	 <b>Massive Snow</b>
 <b>Corsocomo Coconut</b>	 <b>City Plaster White</b>	 <b>Parker White</b>	 <b>Corsocomo Meringue</b>	 <b>Brera Fresh</b>
 <b>Parker Ivory</b>	 <b>Loft Cream</b>	 <b>Select Crema</b>	 <b>Cementine Crema</b>	 <b>Unicolors Panna</b>
 <b>Loft Ash</b>	 <b>Parker Grey</b>	 <b>Massive Cloud</b>	 <b>Massive Ashen</b>	 <b>Unicolors Grigio</b>
 <b>Parker Smoke</b>	 <b>Parker Silver</b>	 <b>Mood Balance</b>	 <b>Corsocomo Storm</b>	 <b>Res-Terrae Corn</b>
 <b>Brera Glow</b>	 <b>Massive Dimgray</b>	 <b>Select Piombo</b>	 <b>Loft Grey</b>	 <b>H24 Black</b>

 <b>Unicolors Ghiaccio</b>	 <b>H24 White</b>	 <b>Loft White</b>	 <b>Select Bianco</b>	 <b>Cementine Bianco</b>
 <b>Select Nebbia</b>	 <b>Concept Pearl</b>	 <b>Massive Deepice</b>	 <b>Brera Bloom</b>	 <b>Brera Street</b>
 <b>Corsocomo Cookie</b>	 <b>City Plaster Beige</b>	 <b>Concept Greige</b>	 <b>Cementine Beige</b>	 <b>Loft Taupe</b>
 <b>City Plaster Grey</b>	 <b>Res-Terrae Backdrop</b>	 <b>Corsocomo Drop</b>	 <b>Cementine Nebbia</b>	 <b>H24 Grey</b>
 <b>Select Cenere</b>	 <b>Select Fumo</b>	 <b>Parker Anthracite</b>	 <b>Cementine Grigio</b>	 <b>Brera Frame</b>
 <b>H24 Moka</b>	 <b>Cementine Moka</b>	 <b>City Plaster Multicolor</b>	 <b>Brera Board</b>	 <b>Cementine Antracite</b>



# Concrete Look



# Concrete Look - WallArt



General index

**Product indexes**  
 Index A-Z  
 Indoor sizes index  
 Outdoor sizes index  
 Colours index

**The Company**

**Collections**

**TH2.0 Outdoor Solutions**

**Bathroom furniture**

**Ventilated facades**

**Technical information**

# Metal Look

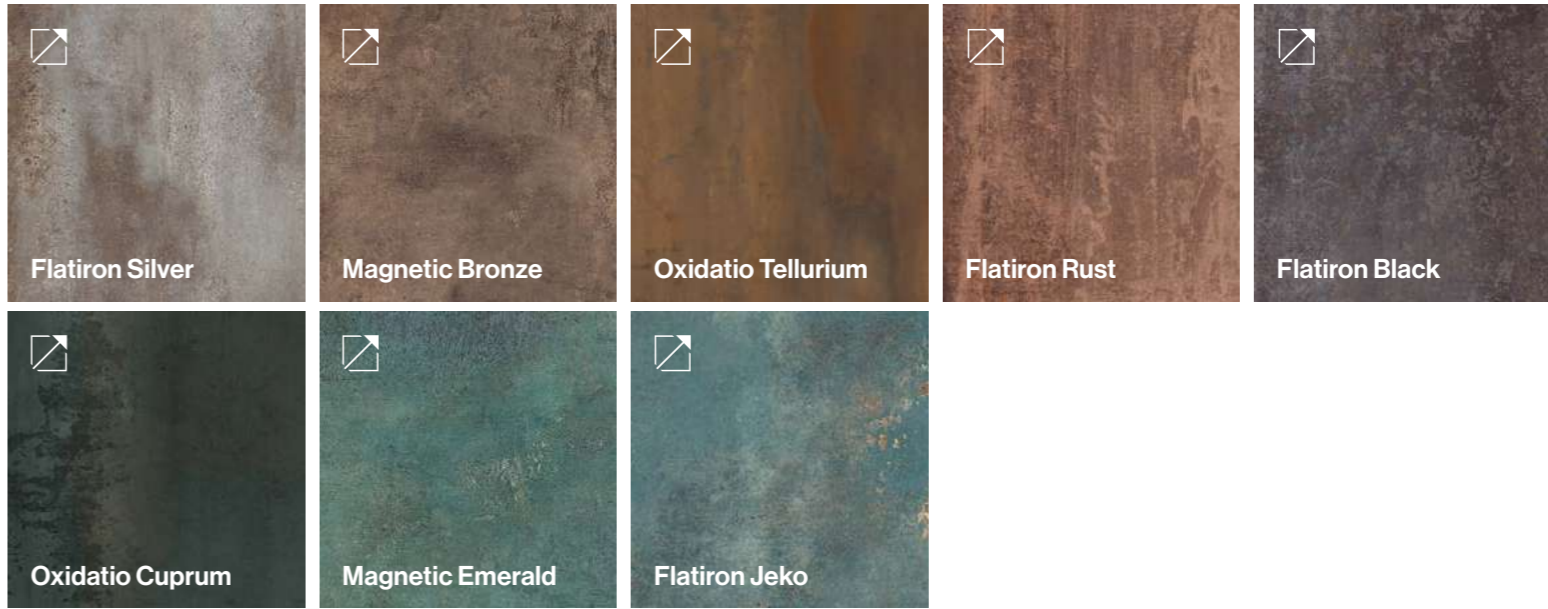

# Wood Look

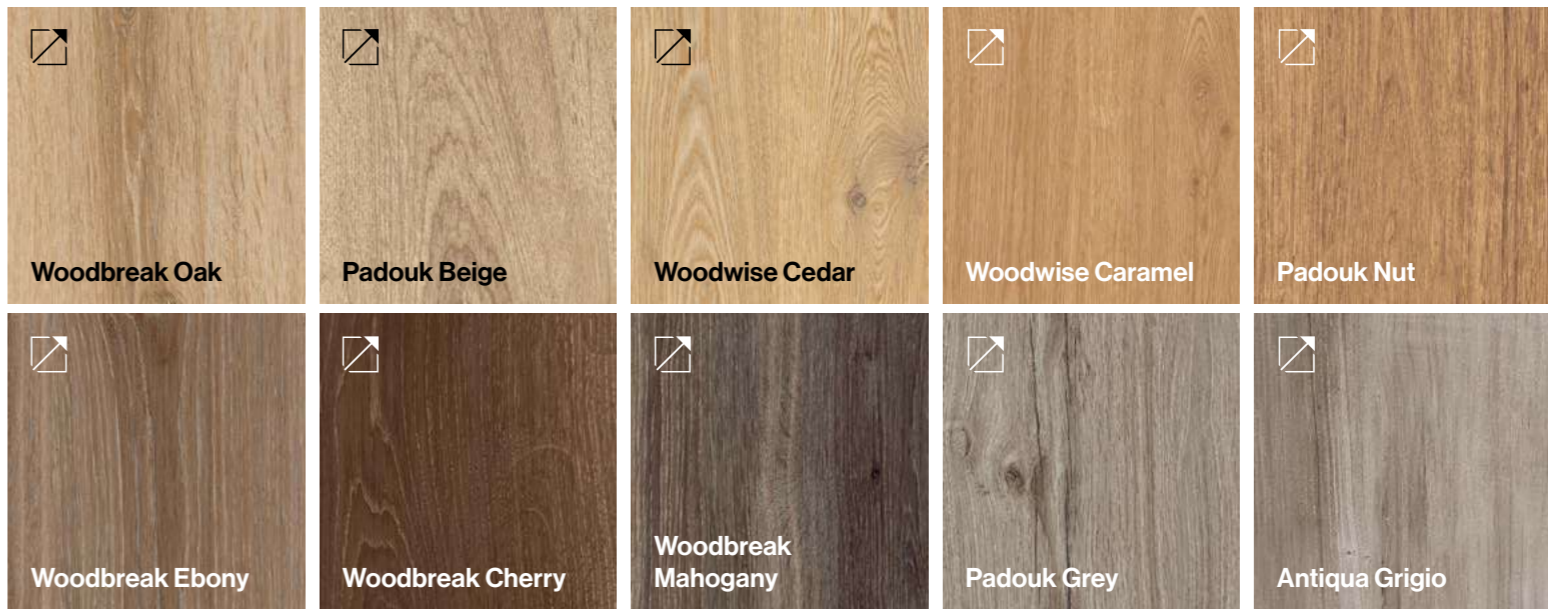
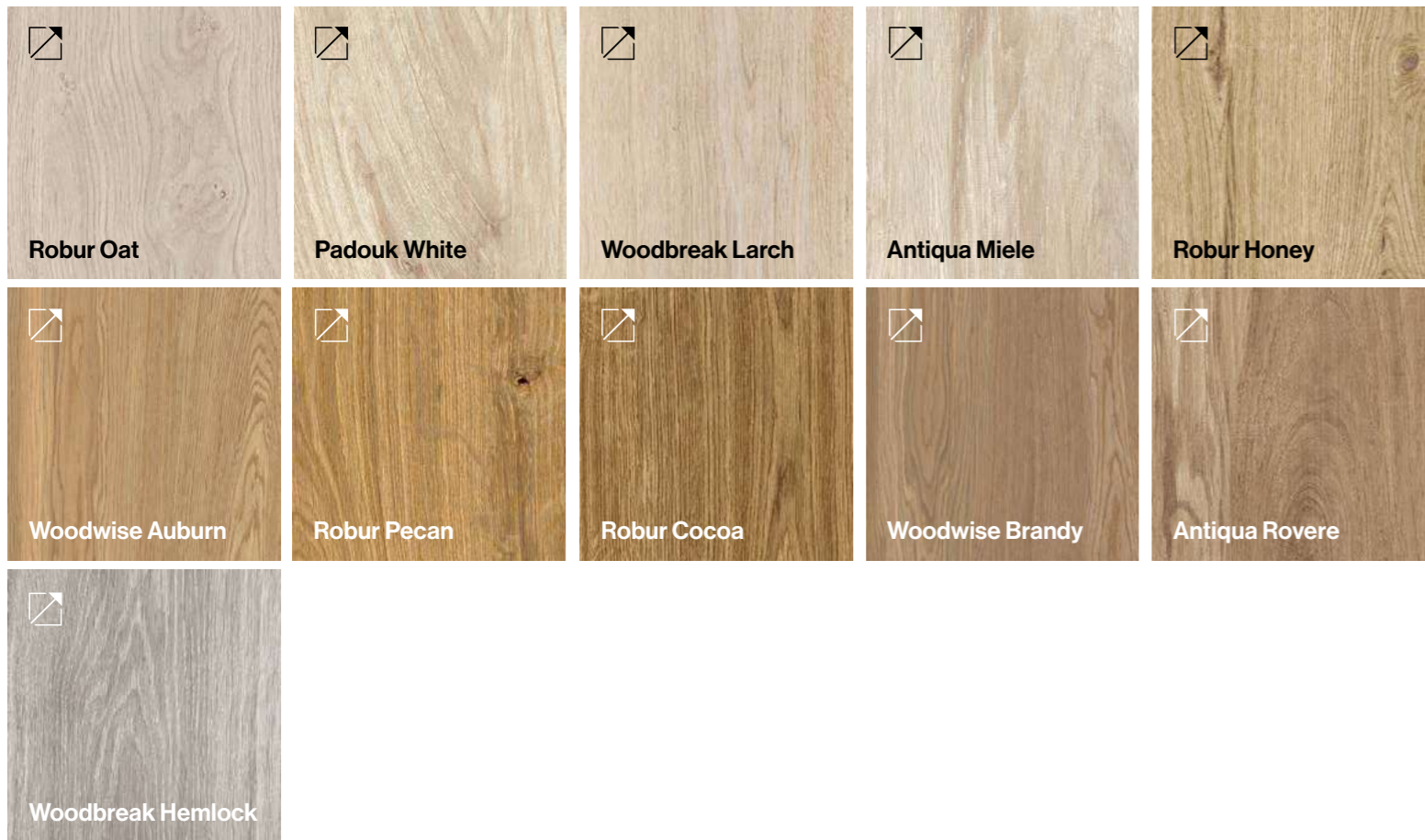

# Cotto Look

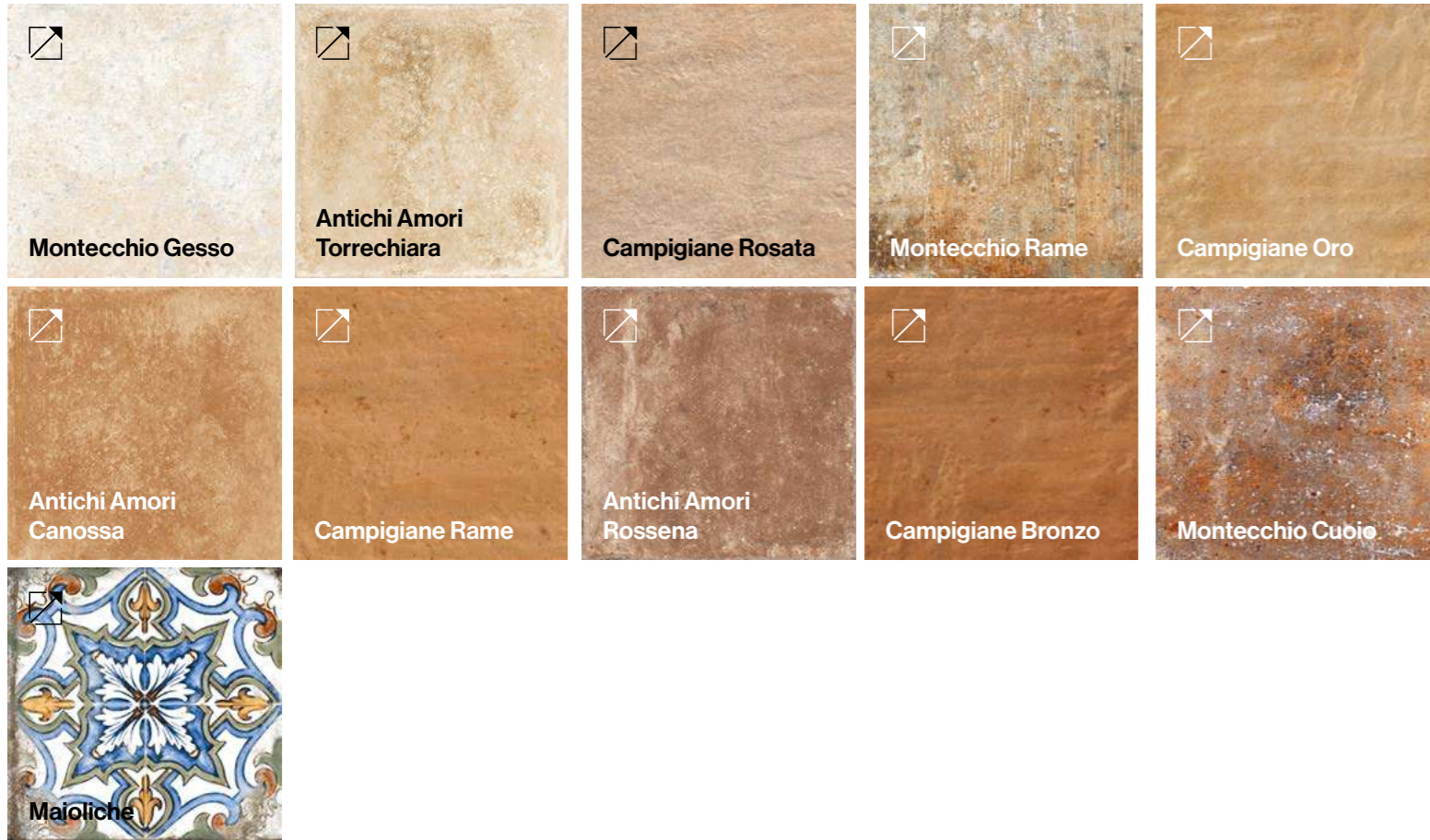

General index

Product indexes

Index A-Z  
 Indoor sizes index  
 Outdoor sizes index  
 Colours index



The Company

Collections

TH2.0  
 Outdoor Solutions

Bathroom furniture

Ventilated facades

Technical information

# TH2.0 Outdoor Solutions

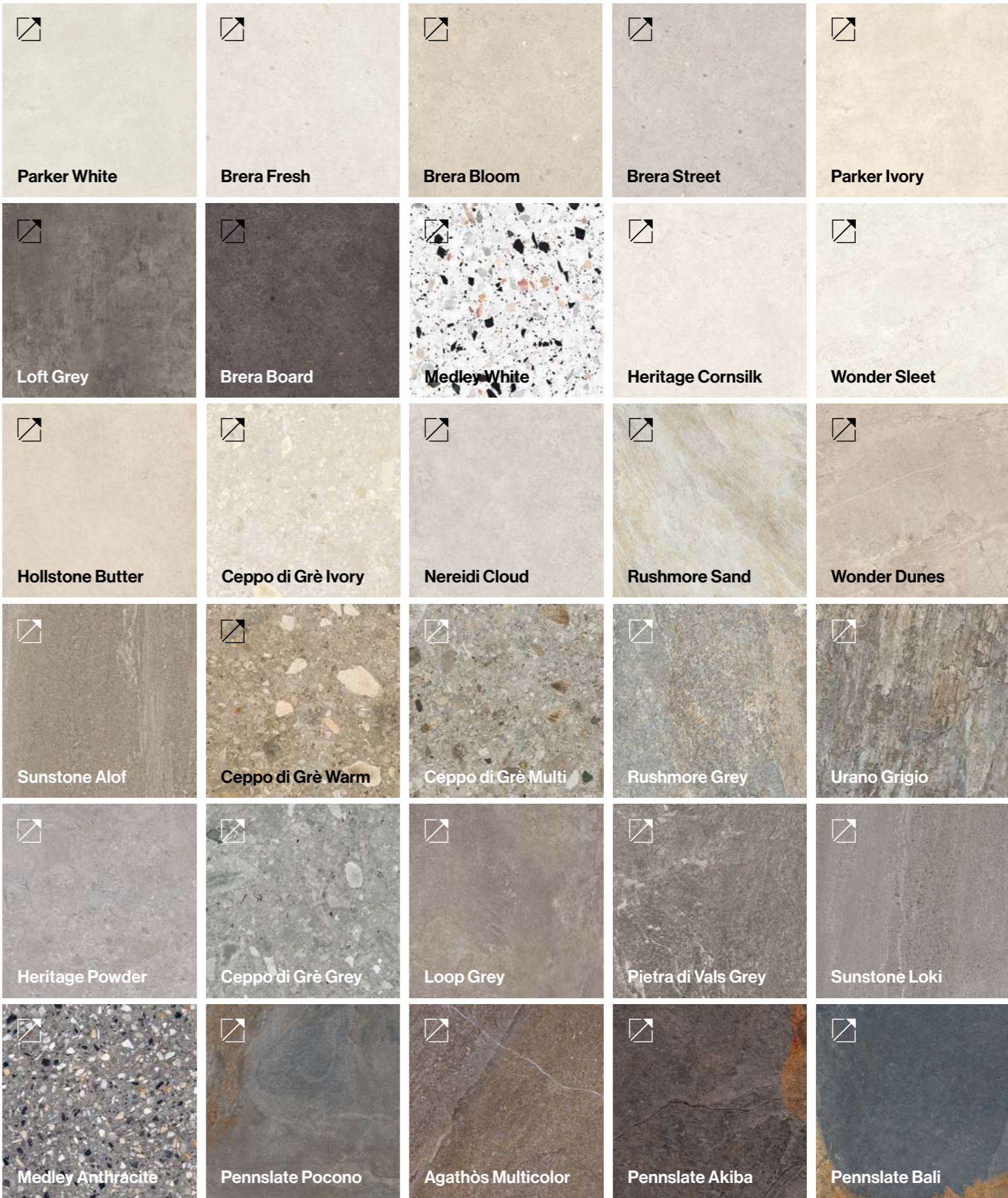

# TH2.0 Outdoor Solutions

 Pennslate Forge	 Rushmore Anthracite	 Basaltina Piombo	 Wonder Brave	 Agathos Anthracite
 Loop Anthracite	 Flatiron White	 Magnetic Grey	 Magnetic Dark Grey	 Magnetic Bronze
 Flatiron Rust	 Flatiron Black	 Magnetic Black	 Padouk White	 Woodbreak Larch
 Robur Honey	 Woodbreak Oak	 Padouk Beige	 Padouk Nut	 Robur Pecan
 Robur Cocoa	 Woodbreak Ebony	 Padouk Grey	 Woodbreak Hemlock	



FLOOR Flatiron. White 80x80 . 32"x32" TH2.0

# Confidence in the future

Fiducia nel futuro. Confiance en l'avenir. Vertrauen in die Zukunft.



General  
index

Product  
indexes

The  
Company



Collections

TH2.0  
Outdoor  
Solutions

Bathroom  
furniture

Ventilated  
facades

Technical  
information

# Excellent Italian Surfaces

Superfici italiane di eccellenza  
Surfaces italiennes d'excellence  
Italienische Oberflächen der Exzellenz

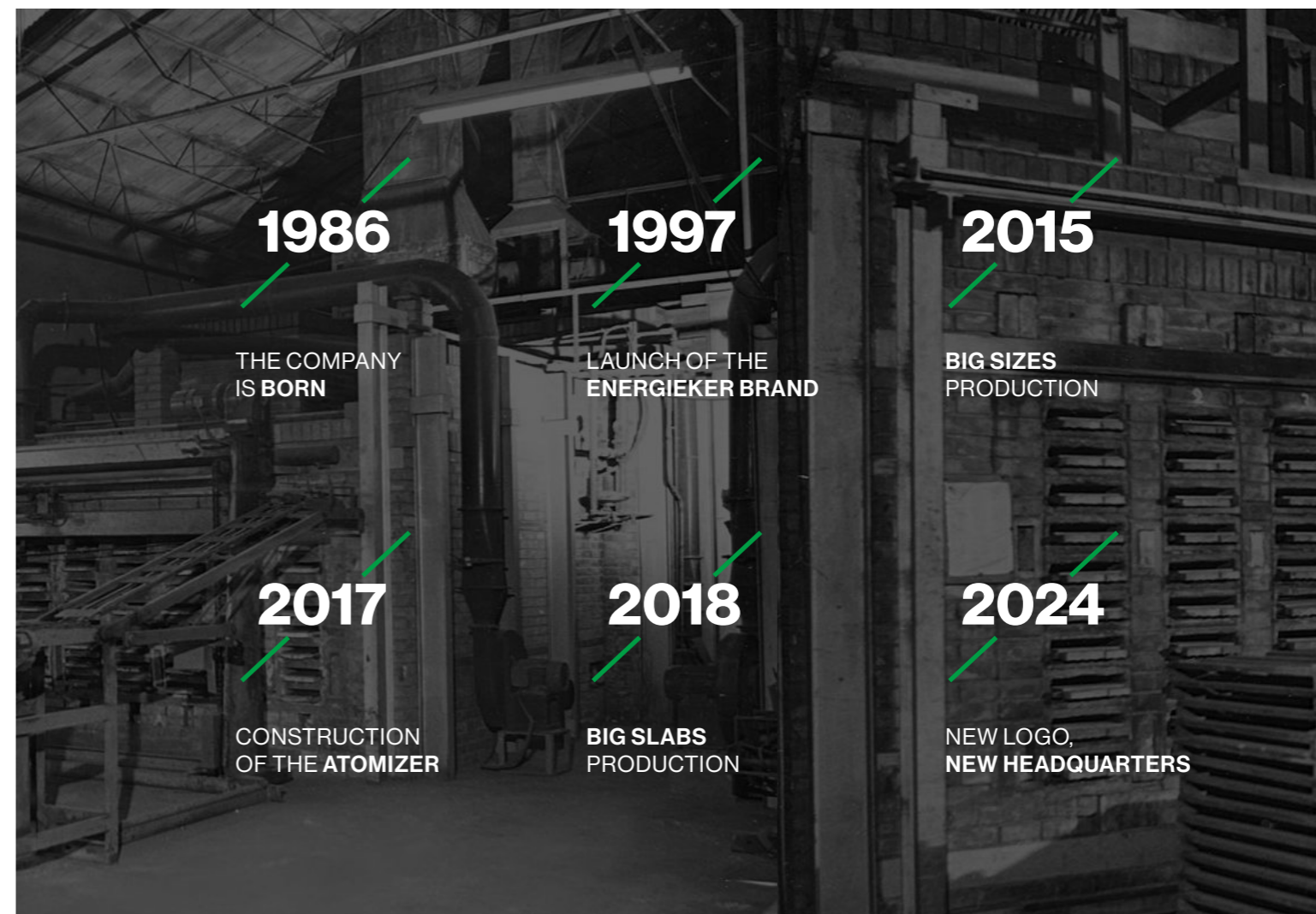

1986

THE COMPANY IS BORN

1997

LAUNCH OF THE ENERGIEKER BRAND

2015

BIG SIZES PRODUCTION

2017

CONSTRUCTION OF THE ATOMIZER

2018

BIG SLABS PRODUCTION

2024

NEW LOGO, NEW HEADQUARTERS

**Energieker is the synthesis of a long ceramic history. The brand was born in 1997 from the relaunch of an industrial reality already existing since 1986. Since then, continuous investments in research and technology contributed to consolidate the company's position in the high-end market, until making it an international protagonist of Made in Italy ceramics. Recently, Energieker has renewed the brand and inaugurated a new prestigious Headquarters in Pavullo, with a showroom of over 1,200 square meters to best display the extraordinary porcelain stoneware collections and large ceramic slabs.**

Energieker è la sintesi di una lunga storia ceramica. Il marchio è nato nel 1997 dal rilancio di una realtà industriale attiva dal 1986. Da allora, i continui investimenti in ricerca e tecnologia lo hanno consolidato nella fascia alta del mercato, fino a renderlo un protagonista internazionale del Made in Italy ceramico. Di recente, Energieker ha rinnovato il marchio e inaugurato un nuovo prestigioso Headquarters a Pavullo, dotato di uno showroom di oltre 1.200 mq per esporre al meglio le straordinarie collezioni in gres porcellanato e le grandi lastre ceramiche.

Energieker est la synthèse d'une longue histoire céramique. La marque est née en 1997 de la relance d'une réalité industrielle existant déjà depuis 1986. Depuis lors, des investissements continus dans la recherche et la technologie l'ont consolidée dans le haut de gamme du marché, jusqu'à en faire un protagoniste international de la céramique Made in Italy. Récemment, Energieker a renouvelé la marque et inauguré un nouveau siège prestigieux à Pavullo, avec un showroom de plus de 1 200 m<sup>2</sup> pour exposer au mieux les extraordinaires collections en grès cérame et les grandes dalles céramiques.

Energieker ist die Synthese einer langen Keramikgeschichte. Die seit 1986 bestehende Marke wurde 1997 wiederbelebt. Durch kontinuierliche Investitionen in Forschung und Technologie gehört Energieker zu den internationalen Protagonisten des oberen Marktsegments mit dem Prädikat „Made in Italy“. Erst vor kurzem hat Energieker das Markenlogo erneuert und seinen prestigeträchtigen Hauptsitz in Pavullo eingeweiht und verfügt nun über einen Showroom von über 1200m<sup>2</sup> um seine aussergewöhnliche Feinsteinzeugkollektionen zu präsentieren.





**In recent years, a huge investment plan has completed our plants with a line dedicated to the production of large porcelain stoneware slabs. Today, our factories are a concentrate of the best ceramic technology in terms of production efficiency and management effectiveness, with optimization of consumption and emissions.**

Negli ultimi anni, un ingente piano di investimenti ha completato i nostri impianti con una linea per la produzione di grandi lastre in gres porcellanato. Oggi, i nostri stabilimenti sono un concentrato della migliore tecnologia ceramica in termini di efficienza produttiva ed efficacia gestionale, con ottimizzazione dei consumi e delle emissioni.

Ces dernières années, un vaste plan d'investissement a complété nos installations avec une ligne de production de grandes dalles en grès cérame. Aujourd'hui, nos usines sont un concentré de la meilleure technologie céramique en termes de efficacité de la production et efficacité de la gestion, avec optimisation des consommations et des émissions.

In den letzten Jahren wurde unser Werk durch einen umfangreichen Investitionsplan mit einer Linie zur Herstellung großer Feinsteinzeugplatten. Heute ist unsere Fabrik ein Konzentrat aus bester Keramiktechnologie in Bezug auf Produktionseffizienz und Wirtschaftlichkeit in Verbindung mit der Optimierung des Verbrauchs und Emissionen.

# Numbers that count

Numeri che contano  
Des chiffres qui comptent  
Zahlen, die zählen

- SINCE **1986**
- TURNOVER\* **110 mln €**
- EMPLOYEES AND CO-WORKERS **+330**
- WORLDWIDE PRESENCE **+100 countries**
- HEADQUARTERS AREA **2,500 sqm**
- TOTAL PRODUCTION AREA **263,000 sqm**
- ANNUAL PRODUCTION\* **+12 mln sqm**
- PRODUCTS RANGE **+80 Collections | +3,000 Product items in catalog**

\* Year 2023

# Where quality meets design

Dove la qualità incontra il design  
Où la qualité rencontre le design  
Wo Qualität auf Design trifft

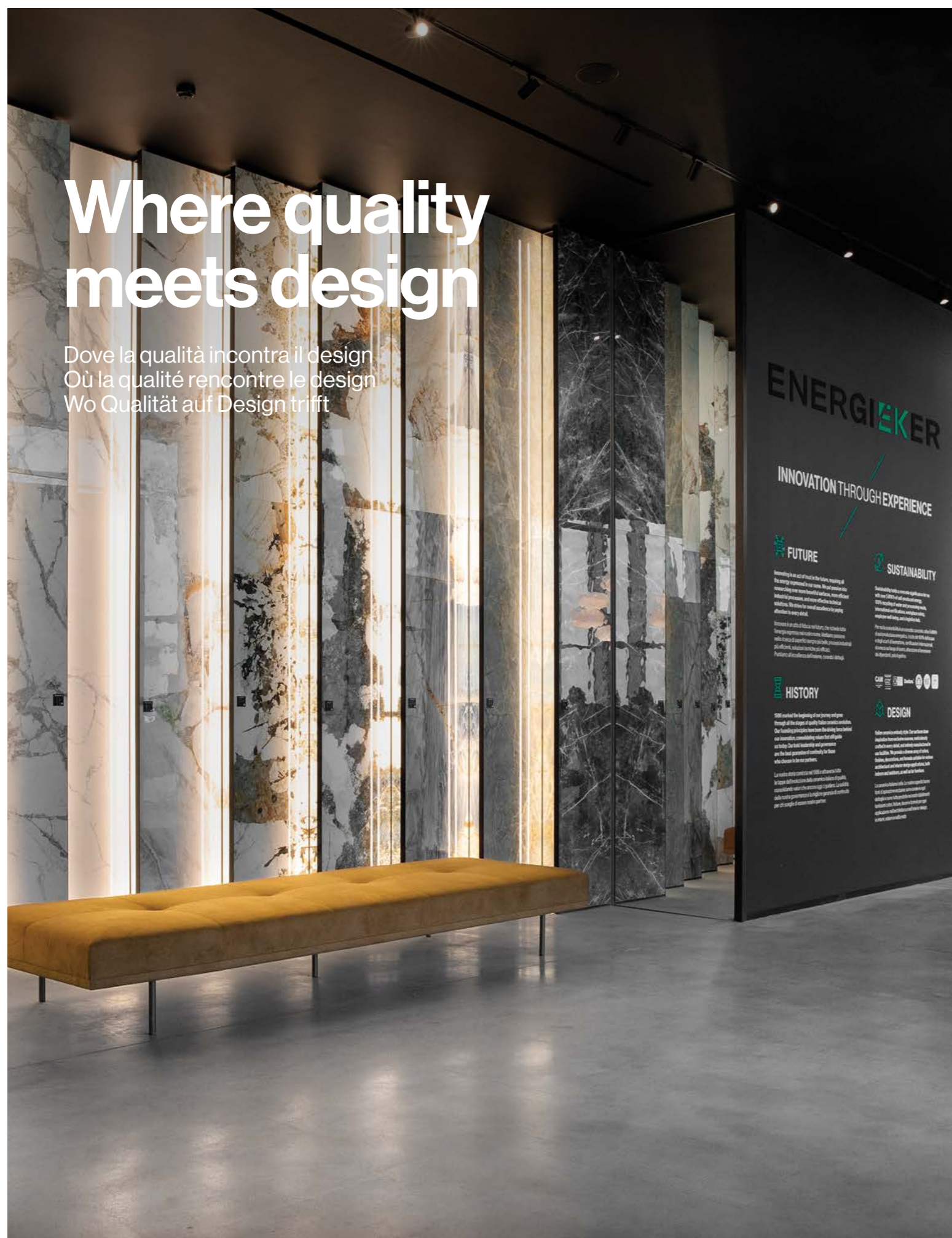

**We offer architects, designers, distributors and users surfaces with the highest technical, aesthetic and quality levels. Our range is complete and varied, with sizes from 30x60 up to 160x320, available in a wide number of surfaces, colors, looks, decorations for indoor and outdoor floors and walls, as well as for tables, worktops and furnishing accessories.**

Ci proponiamo ad architetti, progettisti, distributori e utilizzatori con superfici ai massimi livelli tecnici, estetici e qualitativi. La nostra gamma è completa e variegata, con formati dal 30x60 al 160x320, declinati su un ampio numero di superfici, colori, look, decori per pavimenti e rivestimenti interni ed esterni, così come per tavoli, piani lavoro e complementi di arredo.



Nous proposons aux architectes, designers, distributeurs et utilisateurs des surfaces aux plus hauts niveaux techniques, esthétiques et qualitatifs. Notre gamme est complète et variée, avec des formats du 30x60 au 160x320, déclinés sur un grand nombre de surfaces, couleurs, looks, décors pour sols et murs intérieurs et extérieurs, ainsi que pour tables, plans de travail et compléments d'ameublement.

Wir bieten Architekten, Designern, Händlern und Anwendern, Oberflächen mit höchsten technischen, ästhetischen und qualitativen Ansprüchen. Unser Sortiment ist komplett und vielfältig, mit Formaten von 30x60 bis 160x320, in einer Vielzahl von Oberflächen, Farben, Optiken und Dekoren für Böden und Wände für den Innen- und Außenbereich sowie für Tische, Arbeitsplatten und Einrichtungsgesamtheiten.

# Versatile solutions for every application

Soluzioni versatili per ogni applicazione  
Des solutions polyvalentes pour chaque application  
Vielseitige Lösungen für jede Anwendung

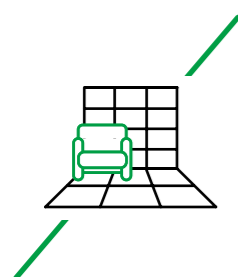

**Internal walls and floors**  
Pareti e pavimenti interni  
Murs et sols intérieurs  
Innenwände und -böden



**Exteriors and swimming pools**  
Esterni e piscine  
Extérieurs et piscines  
Außenbereiche und Schwimmbäder



**Counters and furnishings**  
Banconi e arredi  
Comptoirs et meubles  
Theken und Möbel



**Sinks**  
Lavabi  
Lavabos  
Waschbecken



**External facades**  
Facciate esterne  
Façades extérieures  
Außenfassaden

**Interiors and exteriors merge into a single design vision: floors and walls, swimming pools and surfaces for outdoor spaces, counters, washbasins and ventilated facades. Energieker offers specific solutions for each intended use, to respond with elegance and functionality to different stylistic and application needs.**

Interni ed esterni si fondono in un'unica visione progettuale: pavimenti e pareti, piscine e superfici per spazi outdoor, banconi, lavabi e facciate ventilate. Energieker offre soluzioni specifiche per ogni destinazione d'uso, per rispondere con eleganza e funzionalità a diverse esigenze stilistiche e applicative.

Intérieurs et extérieurs se fondent dans une vision progettuale unique: sols et murs, piscines et surfaces pour espaces extérieurs, comptoirs, lavabos et façades ventilées. Energieker offre des solutions spécifiques pour chaque usage prévu, pour répondre avec élégance et fonctionnalité à différentes exigences stylistiques et applicatives.

Innen und Außen verschmelzen zu einer einzigen Designvision: Böden und Wände, Schwimmbäder und Oberflächen für Außenbereiche, Theken, Waschbecken und hinterlüftete Fassaden. Energieker bietet spezifische Lösungen für jeden Verwendungszweck, um mit Eleganz und Funktionalität auf unterschiedliche stilistische und anwendungstechnische Anforderungen zu reagieren.

## All-around surfaces

Superfici a tutto campo  
Surfaces à tout le niveau  
Allround-Oberflächen

### EK COLLECTIONS

Design for walls and floors  
Design per pareti e pavimenti  
Design sols et murs  
Design für Wände und Böden

### EKXTREME

Thinking big  
Pensare in grande formato  
Penser en grand  
In großen Dimensionen denken

### TOP SOLUTION

Quality furniture and accessories  
Arredi e accessori di qualità  
Meubles et accessoires de qualité  
Hochwertige Möbel und Accessoires

### TH2.0 OUTDOOR SOLUTIONS

Outdoor design  
Design per esterni  
Design pour l'extérieur  
Design für den Außenbereich

General index

Product indexes

The Company

Collections

TH2.0 Outdoor Solutions

Bathroom furniture

Ventilated facades

Technical information

# Technological innovations that enhance design

Innovazioni tecnologiche che valorizzano il design  
Des innovations technologiques qui valorisent le design  
Technologische Innovationen, die das Design aufwerten



HiSense



**HiSense and RST technologies transform ceramics into a unique experience. Thanks to its microparticles, HiSense makes the surface softer to the touch while also improving its anti-slip performance, whereas RST digital engravings reproduce natural details with extraordinary precision.**

Le tecnologie HiSense e RST trasformano la ceramica in un'esperienza unica. HiSense, grazie a microparticelle, rende la superficie più morbida al tatto migliorandone anche le prestazioni antiscivolo, mentre le incisioni digitali di RST restituiscono i dettagli naturali con precisione straordinaria.

Les technologies HiSense et RST transforment la céramique en une expérience unique. Grâce à ses microparticules, HiSense rend la surface plus douce au toucher tout en améliorant ses performances antidérapantes, tandis que les gravures numériques RST reproduisent les détails naturels avec une précision extraordinaire.

Die HiSense- und RST-Technologien verwandeln Keramik in ein einzigartiges Erlebnis. Dank seiner Mikropartikel sorgt HiSense für eine weichere Oberfläche und verbessert gleichzeitig deren Rutschfestigkeit, während die digitalen Gravuren von RST natürliche Details mit außergewöhnlicher Präzision wiedergeben.

# 3D Textures

Texture 3D  
Textures 3D  
3D-Texturen

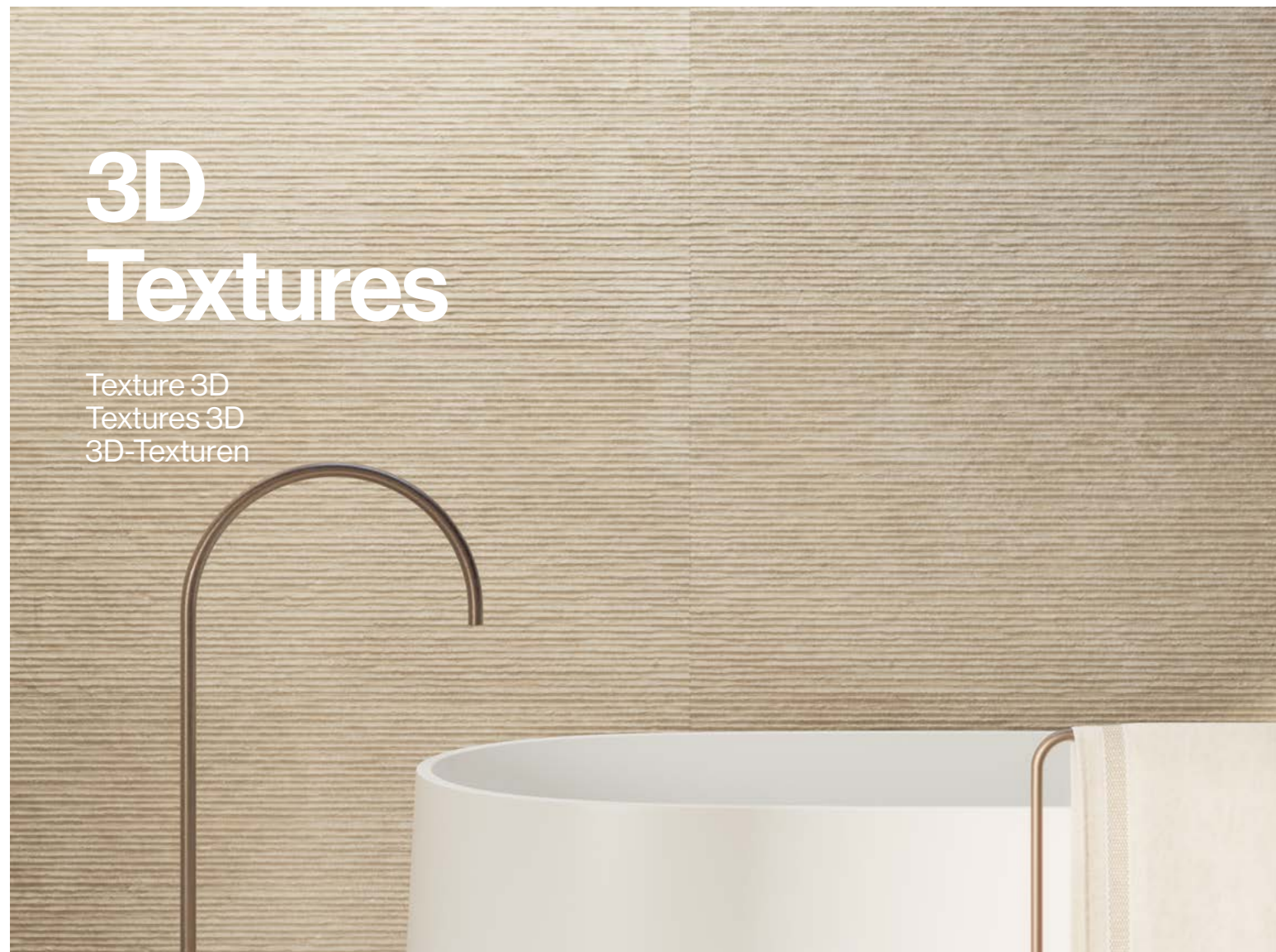

# 6 mm thickness

Spessore 6 mm  
Épaisseur 6 mm  
6 mm Stärke

6 MM



**Energieker elevates the tactile and visual experience of ceramic surfaces with Flow and Groove, two three-dimensional textures that give depth and character to environments. The reliefs enhance the graphics, creating suggestive plays of light and shadow.**

Energieker eleva l'esperienza tattile e visiva delle superfici ceramiche con Flow e Groove, due texture tridimensionali che donano profondità e carattere agli ambienti. I rilievi valorizzano le grafiche, creando suggestivi giochi di luci e ombre.

Energieker élève l'expérience tactile et visuelle des surfaces céramiques avec Flow et Groove, deux textures tridimensionnelles qui donnent de la profondeur et du caractère aux environnements. Les reliefs rehaussent les graphismes, créant de suggestifs jeux d'ombre et de lumière.

Energieker steigert das haptische und visuelle Erlebnis von Keramikoberflächen mit Flow und Groove, zwei dreidimensionalen Texturen, die Tiefe und Charakter verleihen. Die Reliefs werten die Grafiken auf und erzeugen suggestive Licht- und Schattenspiele.

**Energieker 6 mm ceramic slabs combine innovation and sustainability, offering surfaces an uncompromising elegance. Ideal for different types of applications, they maintain the performance of porcelain stoneware, allowing installation even on pre-existing floors.**

Le lastre ceramiche da 6 mm Energieker combinano innovazione e sostenibilità, offrendo alle superfici un'eleganza senza compromessi. Ideali per diversi tipi di applicazione, mantengono intatte le prestazioni del gres porcellanato, consentendo la posa anche su pavimenti preesistenti.

Les dalles céramiques Energieker de 6 mm allient innovation et durabilité, offrant aux surfaces une élégance sans compromis. Idéales pour différents types d'applications, elles conservent les performances du grès cérame, permettant la pose même sur sols préexistants.

Die 6 mm starken Keramikplatten von Energieker vereinen Innovation und Nachhaltigkeit und bieten Oberflächen einer kompromisslosen Eleganz. Ideal für verschiedenste Arten von Anwendungen, behalten sie die Leistung von Feinsteinzeug bei und ermöglichen die Verlegung auch auf bereits vorhandenen Böden.



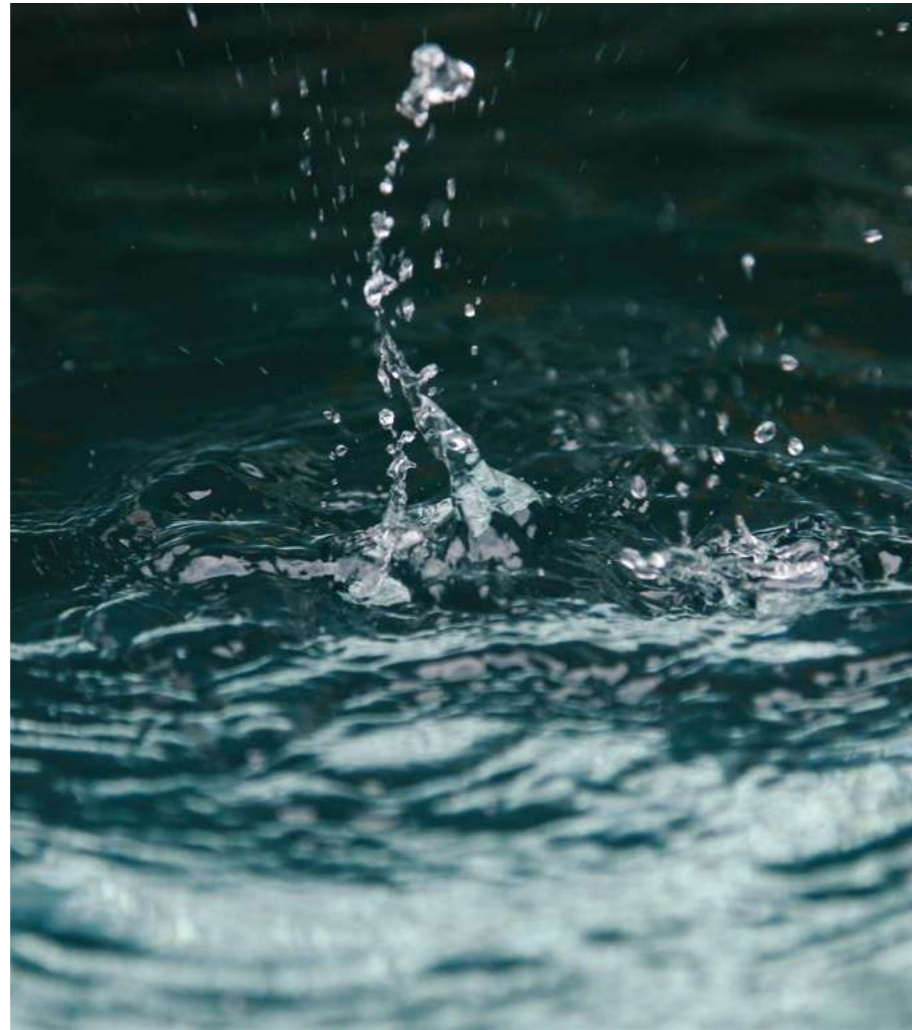

**For us, sustainability is a concrete concept: over 5 MW/h of self-produced energy, 100% recycling of water and processing waste, international certifications, safety in the workplace, attention to the well-being of employees, logistics center. All this translates into a sustainable presence in the area and into a virtuous circle between company, designers, customers and end users.**

Per noi la sostenibilità è un concetto concreto: oltre 5 MW/h di energia autoprodotta, riciclo del 100% dell'acqua e degli scarti di lavorazione, certificazioni internazionali, sicurezza sul luogo di lavoro, attenzione al benessere dei dipendenti, polo logistico. Tutto questo si traduce in una presenza sostenibile sul territorio e in un circolo virtuoso tra azienda, progettisti, clienti e utilizzatori finali.

Pour nous, la durabilité est un concept concret: plus de 5 MW/h d'énergie autoproduite, recyclage à 100 % de l'eau et des déchets de traitement, certifications internationales, sécurité sur le lieu de travail, attention au bien-être des employés, centre logistique. Tout cela se traduit par une présence durable sur le territoire et par un cercle vertueux entre entreprise, designers, clients et utilisateurs finaux.

Nachhaltigkeit ist für uns ein konkretes Konzept: über 5 MW/h Energie selbst erzeugt, 100 % Recycling von Wasser und Produktionsabfällen, internationale Zertifizierungen, Sicherheit am Arbeitsplatz, Aufmerksamkeit für das Wohlbefinden der Mitarbeiter, Logistikzentrum. All dies führt zu einer nachhaltigen Präsenz in der Region und zu einem positiven Kreislauf zwischen Unternehmen, Designern, Kunden und Endverbrauchern.



# A concrete commitment to sustainability

Un impegno concreto per la sostenibilità  
Un engagement concret pour la durabilité  
Ein konkretes Engagement für Nachhaltigkeit

**Our certifications**  
Le nostre certificazioni. Nos certifications. Unsere Zertifizierungen.

CERTIFIED ENVIRONMENTAL MANAGEMENT SYSTEM  
UNI EN ISO 14001:2015

UL  
GREENGUARD  
GOLD

GREEN BUILDING COUNCIL  
ITALIA

放射性水平 2A 类  
Certificazione CCC  
CCG Certification  
Certification CCC  
CCC Zertifizierung

شهادة الجودة  
SASO  
QUALITY MARK

EPD  
ITALY

#ichooseresponsibly  
#ioscelgoresponsabile

# Italian Ceramics. I choose responsibility.

Responsibility towards the world I live in determines every choice I make in my daily life. Italian ceramic companies are dedicated to daily, concrete actions aimed at improving quality of life and respecting the environment.  
**Many companies in other countries do not share this commitment.**

# La Ceramica Italiana. Io scelgo la responsabilità.

La responsabilità verso il mondo in cui vivo riguarda ogni mia scelta, ogni giorno. Le aziende della Ceramica Italiana si impegnano quotidianamente con azioni concrete per migliorare la qualità della vita e rispettare l'ambiente.  
**Tante aziende di altri paesi non fanno altrettanto.**



**DESIGN**  
Designer products  
built to last.

**DESIGN**  
Prodotti di design progettati  
per durare nel tempo.



**ENVIRONMENTAL RESPONSIBILITY**  
Recovery of production waste  
and process water.

**RESPONSABILITÀ AMBIENTALE**  
Recupero degli scarti di produzione  
e delle acque di processo.



**HEALTH**  
No VOC (volatile organic compound)  
emissions into the environment.

**SALUBRITÀ**  
Nessuna emissione di VOC (composti  
organici volatili) negli ambienti.



**SOCIAL RESPONSIBILITY**  
Employees with  
permanent contracts.

**RESPONSABILITÀ SOCIALE**  
Lavoratori con contratti  
a tempo indeterminato.

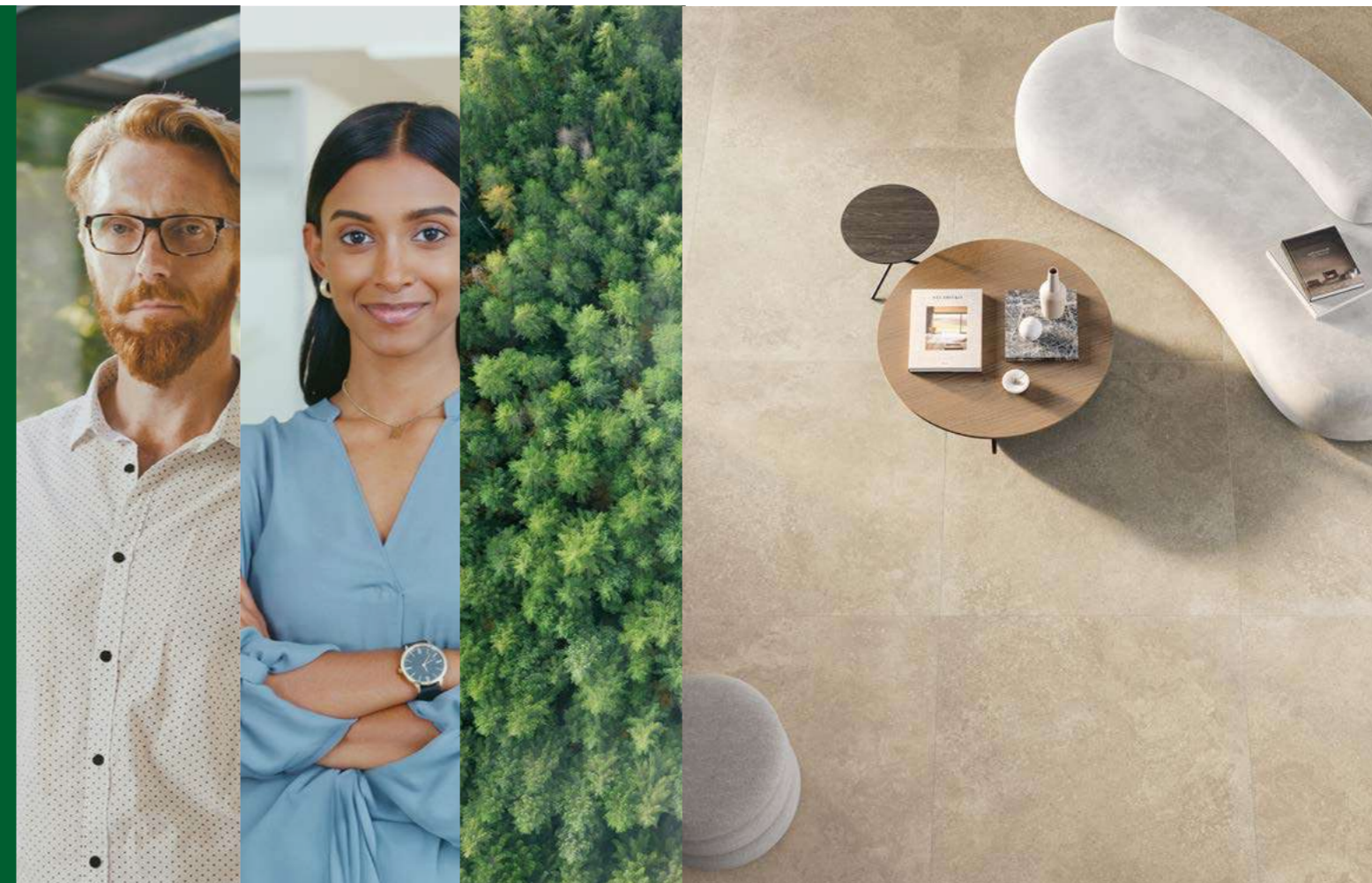

Discover more on the  
sustainability of Italian Ceramics  
Scopri di più sulla sostenibilità  
della Ceramica Italiana

General  
index

Product  
indexes

The  
Company

Collections

TH2.0  
Outdoor  
Solutions

Bathroom  
furniture

Ventilated  
facades

Technical  
information

# Index A - Z

Indice A - Z. Index A - Z. Alphabetisches Verzeichnis.

<b>Amani</b>	<b>Treasures and Gems</b>
<b>Amazonite</b>	
<b>Bernini</b>	<b>Agatina Blue</b>
<b>Calacatta</b>	<b>Alaska</b>
<b>Calacatta Cenerino</b>	<b>Ambre Cloud</b>
<b>Calacatta Oceanic</b>	<b>Botanic Blue</b>
<b>Calacatta Splendido</b>	<b>Bright Precious</b>
<b>Calacatta Viola</b>	<b>Crystal Sea</b>
<b>Carrara Gioia</b>	<b>Emerald Paris</b>
<b>Cashmere</b>	<b>Eternal Blue</b>
<b>Dolomite</b>	<b>Explosion</b>
<b>Dubai Gold</b>	<b>Levante</b>
<b>Invisible Grey</b>	<b>Royal Sodalite</b>
<b>Lincoln</b>	<b>Saint Laurent</b>
<b>Makrana</b>	<b>Sarancollin</b>
<b>Marquiña</b>	<b>Tempest Dedalus</b>
<b>Navona Soft</b>	<b>Warm Ambrosia</b>
<b>Navona Vein</b>	<b>White Beauty</b>
<b>Onyx</b>	
<b>Patagonia</b>	
<b>Pierre Black</b>	
<b>Pietragrey</b>	
<b>Sahara Noir</b>	
<b>Statuario Superiore</b>	
<b>Taj Mahal</b>	
<b>Verde Alpi</b>	

# Marble Look

General index

Product indexes

The Company

## Collections

Marble Look  
Concrete Look  
Stone Look  
Metal Look  
Wood Look  
Cotto Look



TH2.0  
Outdoor  
Solutions

Bathroom  
furniture

Ventilated  
facades

Technical  
information



# Amani

Sophisticated and contemporary



WALL Oud 120x280 . 48"x110"  
FLOOR Cool 120x120 . 48"x48"

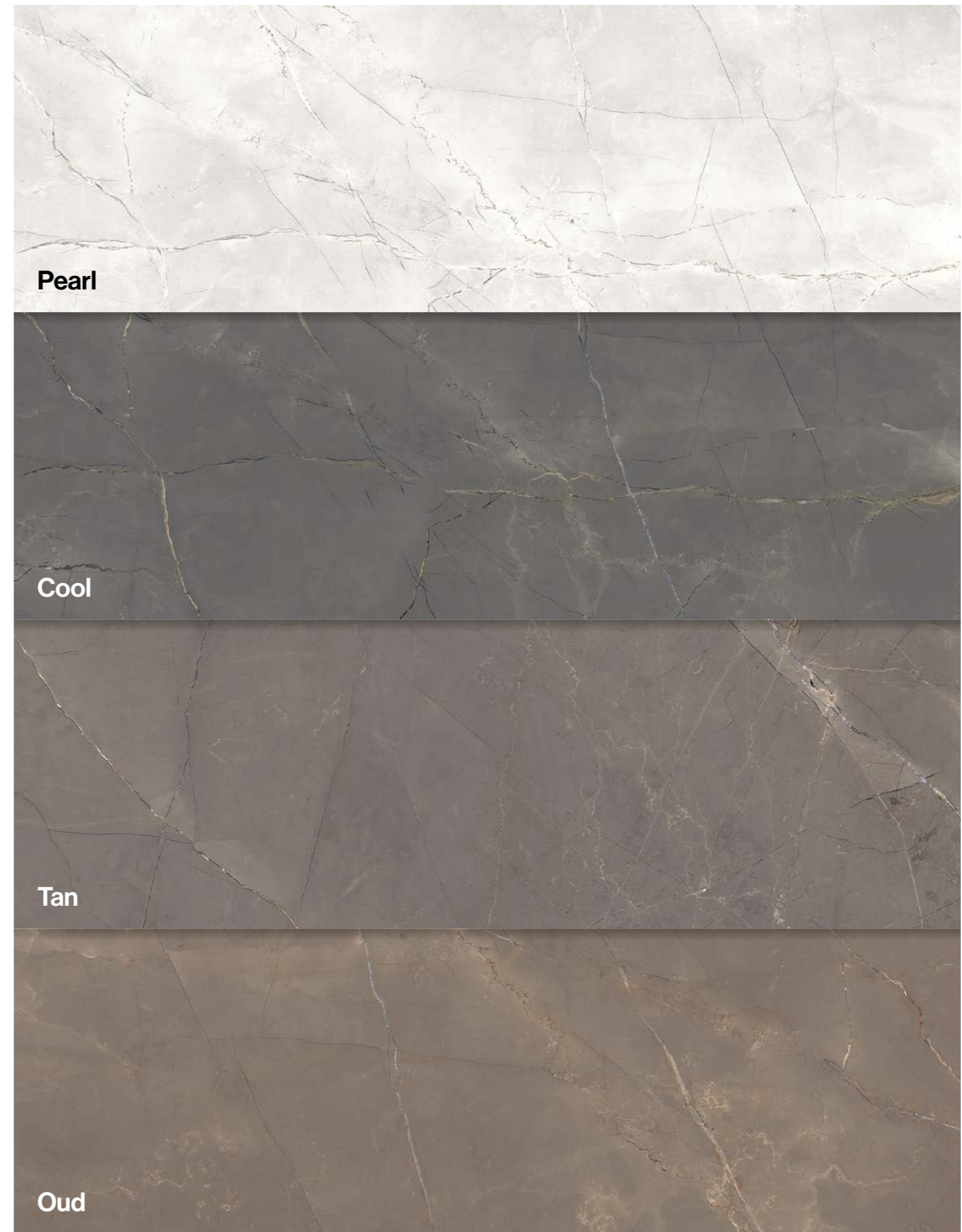

Pearl

Cool

Tan

Oud

General index

Product indexes

The Company

## Collections

Marble Look  
Concrete Look  
Stone Look  
Metal Look  
Wood Look  
Cotto Look



TH2.0  
Outdoor  
Solutions

Bathroom  
furniture

Ventilated  
facades

Technical  
information



Size Formato	Finishes Finiture	Price code sqm Codice prezzo m <sup>2</sup>	Price code sqm Codice prezzo m <sup>2</sup>	Price code sqm Codice prezzo m <sup>2</sup>	Price code sqm Codice prezzo m <sup>2</sup>
	<b>EKTREME 120x280</b> 48"x110" ±6 mm	● 159	● 161	● 161	● 159
	Rectified Rettificato	● 166	● 167	● 167	● 166
	<b>120x120</b> 48"x48" ±9 mm	● 153	● 155	● 155	● 153
	Rectified Rettificato	● 160	● 162	● 162	● 160
	<b>60x120</b> 24"x48" ±9 mm	● 146	● 148	● 148	● 146
	Rectified Rettificato	● 153	● 155	● 155	● 153
	<b>60x60</b> 24"x24" ±9 mm	● 140	● 141	● 141	● 140
	Rectified Rettificato	● 149	● 150	● 150	● 149
	<b>30x60</b> 12"x24" ±9 mm	● 137	● 139	● 139	● 137
	Rectified Rettificato	● 149	● 150	● 150	● 149
	<b>FLOW 60x120</b> 24"x48" ±9 mm	● 151			
	Rectified Rettificato				
	<b>BATTISCOPA 6,5x120</b> 2 1/4"x48"	● 127*	● 127*	● 127*	● 127*
	High Gloss LCP Lappato campo pieno				
	<b>BATTISCOPA 7,5x60</b> 3"x24"	● 107*	● 107*	● 107*	● 107*
	High Gloss LCP Lappato campo pieno				

\* Price code / pc. Codice prezzo / pz.



WALL Pearl 120x280. 48"x110"

### 3D Flow texture.

Struttura 3D Flow. Structure 3D Flow. 3D Flow Textur.



Pearl  
 FLOW  
 60x120 24"x48"  
 ±9 mm  
 RETT

### Mosaics.

Mosaici. Mosaïques. Mosaik.



Pearl  
 MOSAICO ESAGONI  
 26x30 10"x12"  
 LCP

Price code / pc  
 Codice prezzo / pz  
**128**



Cool  
 MOSAICO ESAGONI  
 26x30 10"x12"  
 LCP

Price code / pc  
 Codice prezzo / pz  
**128**



Tan  
 MOSAICO ESAGONI  
 26x30 10"x12"  
 LCP

Price code / pc  
 Codice prezzo / pz  
**128**



Oud  
 MOSAICO ESAGONI  
 26x30 10"x12"  
 LCP

Price code / pc  
 Codice prezzo / pz  
**128**



Marble Look Amani

# Amazzonite

Savage style





WALL Amazzonite 120x280 - 48"x110"

**V3**  
High gloss LCP  
Lappato campo pieno  
Semi-poli brillant  
Hochglanz Lappato

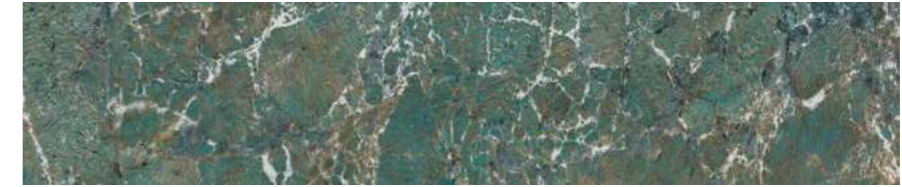
**Porcelain stoneware coloured in body**  
Gres porcellanato colorato in massa  
Grès cérame coloré dans la masse  
Eingefärbtes Feinsteinzeug

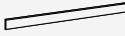

Size Formato	Finishes Finiture	Price code sqm Codice prezzo m <sup>2</sup>	
 <b>EKXTREME</b> <b>120x280</b> 48"x110" → 6 mm	High Gloss LCP Lappato campo pieno	167	•
 <b>60x120</b> 24"x48" → 9 mm	High Gloss LCP Lappato campo pieno	155	•
 <b>BATTISCOPIA</b> <b>6,5x120</b> 2 1/8"x48"	High Gloss LCP Lappato campo pieno	127 *	• 

\* Price code / pc. Codice prezzo / pz.

## Mosaics.

Mosaici. Mosaiques. Mosaik.

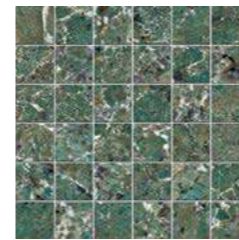

**MOSAICO 36PZ**  
30x30 12"x12"  
LCP

Price code / pc  
Codice prezzo / pz  
**117**

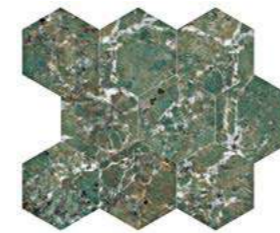

**MOSAICO ESAGONI**  
26x30 10"x12"  
LCP

Price code / pc  
Codice prezzo / pz  
**128**



General  
index

Product  
indexes

The  
Company

## Collections

Marble Look  
Concrete Look  
Stone Look  
Metal Look  
Wood Look  
Cotto Look



TH2.0  
Outdoor  
Solutions

Bathroom  
furniture

Ventilated  
facades

Technical  
information



WALL **Ceppo di Grè. Grey** 120x280 . 48"x110"  
 FIREPIT **Ceppo di Grè. Grey** 120x280 . 48"x110"  
 FLOOR **Bernini** 60x120 . 24"x48"



**R9**  
 Rettificato  
 Rectificado  
 Rectifié  
 Rektifiziert

**High gloss LCP**  
 Lappato campo pieno  
 Semi-poli brillant  
 Hochglanz Lappato

**Porcelain stoneware**  
 Gres porcellanato  
 Grès cérame coloré  
 Feinsteinzeug



Size Formato	Finishes Finiture	Price code sqm Codice prezzo m²
<b>EKTREME</b> <b>120x280</b> 48"x110" → 6 mm	<b>High Gloss LCP</b> Lappato campo pieno	<b>166</b>
<b>60x120</b> 24"x48" → 9 mm	<b>Rectified</b> Rettificato	<b>146</b>
	<b>High Gloss LCP</b> Lappato campo pieno	<b>153</b>
<b>BATTISCOPIA</b> <b>6,5x120</b> 2 1/8"x48"	<b>High Gloss LCP</b> Lappato campo pieno	<b>127*</b>

TOP SOLUTION available\_ see related catalog • Price code / pc. Codice prezzo / pz.  
 TOP SOLUTION disponibile\_ consulta il catalogo

## Mosaics.

Mosaici. Mosaiques. Mosaik.



**MOSAICO 36PZ**  
**30x30** 12"x12"  
**LCP**  
 -  
**30x30** 12"x12"  
**NAT**

Price code / pc  
 Codice prezzo / pz  
**LCP 117**  
**NAT 110**



**MOSAICO ESAGONI**  
**26x30** 10"x12"  
**LCP**  
 -  
**26x30** 10"x12"  
**NAT**

Price code / pc  
 Codice prezzo / pz  
**LCP 128**  
**NAT 122**



# Calacatta

Timeless elegance



WALL Calacatta Mosaico Esagoni 26x30 . 10"x12"  
 FURNITURE Calacatta 163x324 . 64"x127" TOP SOLUTION  
 FLOOR Calacatta 60x60 . 24"x24"

**R9**  
 Rectified  
 Rettificato  
 Rectifié  
 Rektifiziert

**V2**

**High gloss LCP**  
 Lappato campo pieno  
 Semi-poli brillant  
 Hochglanz Lappato

**Porcelain stoneware**  
 Gres porcellanato  
 Grès cérame coloré  
 Feinsteinzeug



Size Formato	Finishes Finiture	Price code sqm Codice prezzo m <sup>2</sup>	
<b>EKTREME</b> 160x320 63"x126" → 6 mm	High Gloss LCP Lappato campo pieno	173	•
<b>EKTREME</b> 120x280 48"x110" → 6 mm	Rectified Rettificato	159	•
	High Gloss LCP Lappato campo pieno	166	•
<b>120x120</b> 48"x48" → 9 mm	Rectified Rettificato	153	•
	High Gloss LCP Lappato campo pieno	160	•
<b>60x120</b> 24"x48" → 9 mm	Rectified Rettificato	146	•
	High Gloss LCP Lappato campo pieno	153	•
<b>60x60</b> 24"x24" → 9 mm	Rectified Rettificato	140	•
	High Gloss LCP Lappato campo pieno	149	•
<b>BATTISCOPIA</b> 6,5x120 2 1/2"x48"	High Gloss LCP Lappato campo pieno	127 *	•
	Rectified Rettificato	106 *	•
<b>BATTISCOPIA</b> 7,5x60 3"x24"	High Gloss LCP Lappato campo pieno	107 *	•

TOP SOLUTION available\_ see related catalog  TH2.0 OUTDOOR SOLUTIONS available   
 TOP SOLUTION disponibile\_ consulta il catalogo  TH2.0 OUTDOOR SOLUTIONS disponibile

\* Price code / pc. Codice prezzo / pz.

## Mosaics.

Mosaici. Mosaïques. Mosaik.



**MOSAICO 36PZ**  
 30x30 12"x12"  
 LCP  
 -  
 30x30 12"x12"  
 NAT  
 Price code / pc  
 Codice prezzo / pz  
**LCP 117**  
**NAT 110**



**MOSAICO ESAGONI**  
 26x30 10"x12"  
 LCP  
 -  
 26x30 10"x12"  
 NAT  
 Price code / pc  
 Codice prezzo / pz  
**LCP 128**  
**NAT 122**



Marble Look Calacatta

General index

Product indexes

The Company

## Collections

Marble Look  
 Concrete Look  
 Stone Look  
 Metal Look  
 Wood Look  
 Cotto Look



TH2.0  
 Outdoor  
 Solutions

Bathroom  
 furniture

Ventilated  
 facades

Technical  
 information

# Calacatta Cenerino

Shades make the difference



WALL Calacatta Cenerino 120x280 - 48"x110"  
FLOOR Calacatta Cenerino 60x120 - 24"x48"





**R9**  
Rectified  
Rettificato  
Rectifié  
Rektifiziert

**V2**

**High gloss LCP**  
Lappato campo pieno  
Semi-poli brillant  
Hochglanz Lappato

**Porcelain stoneware coloured in body**  
Gres porcellanato colorato in massa  
Grès cérame coloré dans la masse  
Eingefärbtes Feinsteinzeug

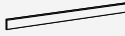

Size Formato	Finishes Finiture	Price code sqm Codice prezzo m <sup>2</sup>	
 <b>EKTREME</b> <b>120x280</b> 48"x110" → 6 mm	<b>High Gloss LCP</b> Lappato campo pieno	<b>167</b>	•
 <b>60x120</b> 24"x48" → 9 mm	<b>Rectified</b> Rettificato	<b>148</b>	•
	<b>High Gloss LCP</b> Lappato campo pieno	<b>155</b>	•
 <b>BATTISCOPIA</b> <b>6,5x120</b> 2 1/8"x48"	<b>High Gloss LCP</b> Lappato campo pieno	<b>127 *</b>	• 

\* Price code / pc. Codice prezzo / pz.

## Mosaics.

Mosaici. Mosaiques. Mosaik.

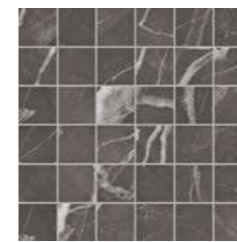

**MOSAICO 36PZ**  
30x30 12"x12"  
LCP

Price code / pc  
Codice prezzo / pz  
**117**



**MOSAICO ESAGONI**  
26x30 10"x12"  
LCP

Price code / pc  
Codice prezzo / pz  
**128**

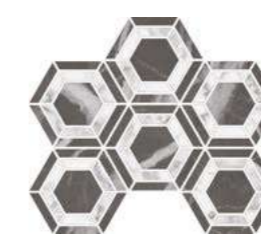

**MOSAICO DOUBLE EXA**  
19,5x25,4 8"x10"  
LCP

Price code / pc  
Codice prezzo / pz  
**138**



General  
index

Product  
indexes

The  
Company

## Collections

**Marble Look**  
Concrete Look  
Stone Look  
Metal Look  
Wood Look  
Cotto Look



TH2.0  
Outdoor  
Solutions

Bathroom  
furniture

Ventilated  
facades

Technical  
information

# Calacatta Oceanic

Wide horizons of style



WALL Calacatta Oceanic 120x280 - 48"x110"







**R9**  
Rectificato  
Rettificato  
Rektifiziert

**High gloss LCP**  
Lappato campo pieno  
Semi-poli brillant  
Hochglanz Lappato

**Porcelain stoneware**  
Gres porcellanato  
Grès cérame coloré  
Feinsteinzeug

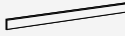

Size Formato	Finishes Finiture	Price code sqm Codice prezzo m <sup>2</sup>	
 <b>EKTREME</b> <b>120x280</b> 48"x110" → 6 mm	<b>High Gloss LCP</b> Lappato campo pieno	<b>166</b>	•
 <b>60x120</b> 24"x48" → 9 mm	<b>Rectified</b> Rettificato	<b>146</b>	•
	<b>High Gloss LCP</b> Lappato campo pieno	<b>153</b>	•
 <b>BATTISCOPIA</b> <b>6,5x120</b> 2 1/8"x48"	<b>High Gloss LCP</b> Lappato campo pieno	<b>127 *</b>	• 

\* Price code / pc. Codice prezzo / pz.

## Mosaics.

Mosaici. Mosaiques. Mosaik.



**MOSAICO 36PZ**  
**30x30 12"x12"**  
**LCP**  
-  
**30x30 12"x12"**  
**NAT**

Price code / pc  
Codice prezzo / pz  
**LCP 117**  
**NAT 110**



**MOSAICO ESAGONI**  
**26x30 10"x12"**  
**LCP**  
-  
**26x30 10"x12"**  
**NAT**

Price code / pc  
Codice prezzo / pz  
**LCP 128**  
**NAT 122**



**MOSAICO HERRINGBONE**  
**33,5x33,5 13"x13"**  
**NAT**

Price code / pc  
Codice prezzo / pz  
**121**



General  
index

Product  
indexes

The  
Company

## Collections

**Marble Look**  
Concrete Look  
Stone Look  
Metal Look  
Wood Look  
Cotto Look



TH2.0  
Outdoor  
Solutions

Bathroom  
furniture

Ventilated  
facades

Technical  
information

# Calacatta Splendido

Pure white prestige



**R9**  
Rectificato  
Rettificato  
Rektifiziert

**High gloss LCP**  
Lappato campo pieno  
Semi-poli brillant  
Hochglanz Lappato

**Porcelain stoneware**  
Gres porcellanato  
Grès cérame coloré  
Feinsteinzeug



WALL Calacatta Splendido Flow 60x120 . 24"x48"  
FLOOR Calacatta Splendido 120x120 . 48"x48"

Size Formato	Finishes Finiture	Price code sqm Codice prezzo m²	
 <b>EKTREME</b> <b>120x280</b> 48"x110" → 6 mm	Rectified Rettificato	159	•
	High Gloss LCP Lappato campo pieno	166	•
 <b>120x120</b> 48"x48" → 9 mm	Rectified Rettificato	153	•
	High Gloss LCP Lappato campo pieno	160	•
 <b>60x120</b> 24"x48" → 9 mm	Rectified Rettificato	146	•
	High Gloss LCP Lappato campo pieno	153	•
 FLOW <b>60x120</b> 24"x48" → 9 mm	Rectified Rettificato	151	•
 BATTISCOPA <b>6,5x120</b> 2 1/8"x48"	High Gloss LCP Lappato campo pieno	127 *	
 BATTISCOPA <b>7,5x60</b> 3"x24"	High Gloss LCP Lappato campo pieno	107 *	

TOP SOLUTION available\_ see related catalog • Price code / pc. Codice prezzo / pz.  
TOP SOLUTION disponibile\_ consulta il catalogo

### 3D Flow texture.

Struttura 3D Flow. Structure 3D Flow. 3D Flow Textur.



FLOW  
60x120 24"x48"  
→ 9 mm  
RETT

### Mosaics.

Mosaici. Mosaïques. Mosaik.



MOSAICO ESAGONI  
26x30 10"x12"  
LCP  
Price code / pc  
Codice prezzo / pz  
128



General  
index

Product  
indexes

The  
Company

### Collections

Marble Look  
Concrete Look  
Stone Look  
Metal Look  
Wood Look  
Cotto Look



TH2.0  
Outdoor  
Solutions

Bathroom  
furniture

Ventilated  
facades

Technical  
information



# Calacatta Viola

An inimitable style



WALL Calacatta Viola 120x280 . 48"x110"  
FLOOR Massivo . Deepice 120x120 . 48"x48"



WALL Calacatta Viola 120x280 . 48"x110"

General index

Product indexes

The Company

### Collections

- Marble Look
- Concrete Look
- Stone Look
- Metal Look
- Wood Look
- Cotto Look



TH2.0  
Outdoor  
Solutions

Bathroom  
furniture

Ventilated  
facades

Technical  
information

# Calacatta Viola

**R9**  
 Rectified  
 Rettificato  
 Rectifié  
 Rektifiziert

**V2**

**High gloss LCP**  
 Lappato campo pieno  
 Semi-poli brillant  
 Hochglanz Lappato

**Porcelain stoneware**  
 Gres porcellanato  
 Grès cérame coloré  
 Feinsteinzeug



Size Formato	Finishes Finiture	Price code sqm Codice prezzo m²	
 <b>EKTREME</b> <b>120x280</b> 48"x110" → 6 mm	Rectified Rettificato	159	●
	High Gloss LCP Lappato campo pieno	166	●
 <b>EKTREME</b> <b>BOOKMATCH</b> <b>120x280</b> 48"x110" → 6 mm	High Gloss LCP Lappato campo pieno	170	●
 <b>120x120</b> 48"x48" → 9 mm	Rectified Rettificato	153	●
	High Gloss LCP Lappato campo pieno	160	●
 <b>60x120</b> 24"x48" → 9 mm	Rectified Rettificato	146	●
	High Gloss LCP Lappato campo pieno	153	●
 <b>60x60</b> 24"x24" → 9 mm	Rectified Rettificato	140	●
	High Gloss LCP Lappato campo pieno	149	●
 <b>30x60</b> 12"x24" → 9 mm	Rectified Rettificato	137	●
	High Gloss LCP Lappato campo pieno	149	●
 <b>FLOW</b> <b>60x120</b> 24"x48" → 9 mm	Rectified Rettificato	151	●
 <b>BATTISCOPA</b> <b>6,5x120</b> 2 1/8"x48"	High Gloss LCP Lappato campo pieno	127 *	●
 <b>BATTISCOPA</b> <b>7,5x60</b> 3"x24"	High Gloss LCP Lappato campo pieno	107 *	●

TOP SOLUTION available\_see related catalog  • Price code / pc. Codice prezzo / pz.  
 TOP SOLUTION disponibile\_consulta il catalogo

## 3D Flow texture. Struttura 3D Flow. Structure 3D Flow. 3D Flow Textur.



FLOW  
 60x120 24"x48"  
 → 9 mm  
 RETT

## Mosaics. Mosaici. Mosaiques. Mosaik.



MOSAICO ESAGONI  
 26x30 10"x12"  
 LCP  
 Price code / pc  
 Codice prezzo / pz  
 128

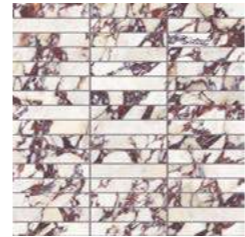

MOSAICO BACCHETTE  
 30x30 12"x12"  
 LCP  
 Price code / pc  
 Codice prezzo / pz  
 128



## Bookmatch.

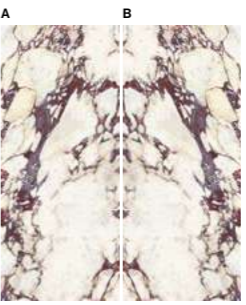

Composition 1



Composition 2



Composition 3



Composition 4

The image shown is for illustrative purposes only. As with natural marble slabs, Bookmatch patterns may present vein discontinuities between one slab and another. For this reason, differences of up to 1.5 cm are to be considered normal product characteristics. L'immagine rappresentata è a puro scopo illustrativo. Come per le lastre di marmo naturale, anche le grafiche Bookmatch possono presentare discontinuità tra una lastra e l'altra. Per questa ragione, differenze fino a 1,5 cm sono da considerarsi normali caratteristiche del prodotto.



# Carrara Gioia

The joy of purity



WALL Carrara Gioia 120x280 - 48"x110"



**R9**  
Rectificato  
Rettificato  
Rektifiziert

**High gloss LCP**  
Lappato campo pieno  
Semi-poli brillant  
Hochglanz Lappato

**Porcelain stoneware**  
Gres porcellanato  
Grès cérame coloré  
Feinsteinzeug



Size Formato	Finishes Finiture	Price code sqm Codice prezzo m <sup>2</sup>	
<b>EKTREME</b> <b>120x280</b> 48"x110" → 6 mm	<b>High Gloss LCP</b> Lappato campo pieno	<b>166</b>	•
<b>120x120</b> 48"x48" → 9 mm	<b>Rectified</b> Rettificato	<b>153</b>	•
	<b>High Gloss LCP</b> Lappato campo pieno	<b>160</b>	•
<b>60x120</b> 24"x48" → 9 mm	<b>Rectified</b> Rettificato	<b>146</b>	•
	<b>High Gloss LCP</b> Lappato campo pieno	<b>153</b>	•
<b>BATTISCOPIA</b> <b>6,5x120</b> 2 1/4"x48"	<b>High Gloss LCP</b> Lappato campo pieno	<b>127*</b>	•

\* Price code / pc. Codice prezzo / pz.

## Mosaics.

Mosaici. Mosaiques. Mosaik.



**MOSAICO 36PZ**  
30x30 12"x12"  
LCP

Price code / pc  
Codice prezzo / pz  
**117**



**MOSAICO ESAGONI**  
26x30 10"x12"  
LCP

Price code / pc  
Codice prezzo / pz  
**128**



General  
index

Product  
indexes

The  
Company

## Collections

**Marble Look**  
Concrete Look  
Stone Look  
Metal Look  
Wood Look  
Cotto Look



TH2.0  
Outdoor  
Solutions

Bathroom  
furniture

Ventilated  
facades

Technical  
information

# Cashmere

Warm feeling



WALL **Peltro** 60x120 . 24"x48"  
FLOOR **Oyster** 60x60 . 24"x24"



**White**

**Oyster**

**Visone**

**Peltro**

General index

Product indexes

The Company

**Collections**  
 Marble Look  
 Concrete Look  
 Stone Look  
 Metal Look  
 Wood Look  
 Cotto Look



TH2.0 Outdoor Solutions

Bathroom furniture

Ventilated facades

Technical information

# Cashmere

**R9**  
 Rectified  
 Rettificato  
 Rectifié  
 Rektifiziert

**V2**

**High gloss LCP**  
 Lappato campo pieno  
 Semi-poli brillant  
 Hochglanz Lappato

**Porcelain stoneware coloured in body**  
 Gres porcellanato colorato in massa  
 Grès cérame coloré dans la masse  
 Eingefärbtes Feinsteinzeug



Size Formato	Finishes Finiture	Price code sqm Codice prezzo m <sup>2</sup>	White	Oyster	Visone	Peltro
<b>60x120</b> 24"x48" →9 mm	Rectified Rettificato	146	•	•	•	•
	High Gloss LCP Lappato campo pieno	153	•	•	•	•
<b>60x60</b> 24"x24" →9 mm	Rectified Rettificato	140	•	•	•	•
	Rectified Rettificato	137	•	•	•	•
<b>30x60</b> 12"x24" →9 mm	Rectified Rettificato	137	•	•	•	•
	High Gloss LCP Lappato campo pieno	127*	•	•	•	•
<b>BATTISCOPA</b> <b>6,5x120</b> 2 1/8"x48"	High Gloss LCP Lappato campo pieno	127*	•	•	•	•

\* Price code / pc. Codice prezzo / pz.



WALL White 60x120 . 24"x48"

## Mosaics.

Mosaici. Mosaïques. Mosaik.



White  
 MOSAICO 36PZ  
 30x30 12"x12"  
 NAT  
 Price code / pc  
 Codice prezzo / pz  
**110**



Oyster  
 MOSAICO 36PZ  
 30x30 12"x12"  
 NAT  
 Price code / pc  
 Codice prezzo / pz  
**110**



Visone  
 MOSAICO 36PZ  
 30x30 12"x12"  
 NAT  
 Price code / pc  
 Codice prezzo / pz  
**110**



Peltro  
 MOSAICO 36PZ  
 30x30 12"x12"  
 NAT  
 Price code / pc  
 Codice prezzo / pz  
**110**



General index

Product indexes

The Company

### Collections

- Marble Look
- Concrete Look
- Stone Look
- Metal Look
- Wood Look
- Cotto Look



TH2.0  
 Outdoor  
 Solutions

Bathroom  
 furniture

Ventilated  
 facades

Technical  
 information

# Dolomite

Natural beauty









FLOOR Dolomite 60x120 . 24"x48"  
FURNITURE Calacatta Cenerino 120x280 . 48"x110"

**R9**  
Rectificato  
Rettificato  
Rectifié  
Rektifiziert

**High gloss LCP**  
Lappato campo pieno  
Semi-poli brillant  
Hochglanz Lappato

**Porcelain stoneware**  
Gres porcellanato  
Grès cérame coloré  
Feinsteinzeug



Size Formato	Finishes Finiture	Price code sqm Codice prezzo m²	
 <b>EKXTREME</b> <b>120x280</b> 48"x110" → 6 mm	Rectified Rettificato	159	•
	High Gloss LCP Lappato campo pieno	166	•
 <b>60x120</b> 24"x48" → 9 mm	Rectified Rettificato	146	•
	High Gloss LCP Lappato campo pieno	153	•
 <b>30x60</b> 12"x24" → 9 mm	Rectified Rettificato	137	•
	High Gloss LCP Lappato campo pieno	149	•
 <b>BATTISCOPIA</b> <b>6,5x120</b> 2 1/4"x48"	High Gloss LCP Lappato campo pieno	127 *	 •
 <b>BATTISCOPIA</b> <b>7,5x60</b> 3"x24"	Rectified Rettificato	106 *	 •

TOP SOLUTION available, see related catalog  • Price code / pc. Codice prezzo / pz.  
TOP SOLUTION disponibile, consulta il catalogo

## Mosaics.

Mosaici. Mosaiques. Mosaik.



MOSAICO 36PZ  
30x30 12"x12"  
NAT  
Price code / pc  
Codice prezzo / pz  
110



MOSAICO ESAGONI  
26x30 10"x12"  
NAT  
Price code / pc  
Codice prezzo / pz  
122



MOSAICO BASKET  
30x30 12"x12"  
LCP  
Price code / pc  
Codice prezzo / pz  
126



General index

Product indexes

The Company

## Collections

Marble Look  
Concrete Look  
Stone Look  
Metal Look  
Wood Look  
Cotto Look



TH2.0  
Outdoor  
Solutions

Bathroom  
furniture

Ventilated  
facades

Technical  
information

# Dubai Gold

Exclusive attitude



WALL Dubai Gold 120x280 - 48"x110"







**R9**  
 Rectified  
 Rettificato  
 Rectifié  
 Rektifiziert

**V2**

**High gloss LCP**  
 Lappato campo pieno  
 Semi-poli brillant  
 Hochglanz Lappato

**Porcelain stoneware**  
 Gres porcellanato  
 Grès cérame coloré  
 Feinsteinzeug



Size Formato	Finishes Finiture	Price code sqm Codice prezzo m²	
 <b>EKTREME</b> <b>120x280</b> 48"x110" → 6 mm	Rectified Rettificato	159	•
	High Gloss LCP Lappato campo pieno	166	•
 <b>120x120</b> 48"x48" → 9 mm	Rectified Rettificato	153	•
	High Gloss LCP Lappato campo pieno	160	•
 <b>60x120</b> 24"x48" → 9 mm	Rectified Rettificato	146	•
	High Gloss LCP Lappato campo pieno	153	•
 <b>BATTISCOPIA</b> <b>6,5x120</b> 2 1/4"x48"	Rectified Rettificato	120 *	
	High Gloss LCP Lappato campo pieno	127 *	

TOP SOLUTION available\_see related catalog  • Price code / pc. Codice prezzo / pz.  
 TOP SOLUTION disponibile\_consulta il catalogo

**Mosaics.**  
 Mosaici. Mosaiques. Mosaik.



MOSAICO ESAGONI  
 26x30 10"x12"  
 LCP  
 Price code / pc.  
 Codice prezzo / pz.  
**128**



General index

Product indexes

The Company

**Collections**  
 Marble Look  
 Concrete Look  
 Stone Look  
 Metal Look  
 Wood Look  
 Cotto Look



TH2.0  
 Outdoor  
 Solutions

Bathroom  
 furniture

Ventilated  
 facades

Technical  
 information

# Invisible Grey

Unforgettable nuance



WALL Invisible Grey 120x280 - 48"x110"  
FLOOR Invisible Grey 60x120 - 24"x48"



**R9**  
Rectified  
Rettificato  
Rektifiziert

**High gloss LCP**  
Lappato campo pieno  
Semi-poli brillant  
Hochglanz Lappato

**Porcelain stoneware**  
Gres porcellanato  
Grès cérame coloré  
Feinsteinzeug



Size Formato	Finishes Finiture	Price code sqm Codice prezzo m²	
 <b>EKTREME</b> <b>120x280</b> 48"x110" → 6 mm	Rectified Rettificato	<b>162</b>	•
	High Gloss LCP Lappato campo pieno	<b>166</b>	•
 <b>60x120</b> 24"x48" → 9 mm	Rectified Rettificato	<b>146</b>	•
	High Gloss LCP Lappato campo pieno	<b>153</b>	•
 <b>BATTISCOPA</b> <b>6,5x120</b> 2 1/8"x48"	High Gloss LCP Lappato campo pieno	<b>127 *</b>	•

\* Price code / pc. Codice prezzo / pz.

### Mosaics. Mosaici. Mosaiques. Mosaik.



MOSAICO ESAGONI  
26x30 10"x12"  
LCP  
Price code / pc.  
Codice prezzo / pz  
**128**



General index

Product indexes

The Company

**Collections**  
Marble Look  
Concrete Look  
Stone Look  
Metal Look  
Wood Look  
Cotto Look



TH2.0  
Outdoor  
Solutions

Bathroom  
furniture

Ventilated  
facades

Technical  
information



# Lincoln

Eternal marble perfection



WALL Lincoln 120x280 . 48"x110"



**R9**  
Rectificato  
Rettificato  
Rektifiziert

**High gloss LCP**  
Lappato campo pieno  
Semi-poli brillant  
Hochglanz Lappato

**Porcelain stoneware**  
Gres porcellanato  
Grès cérame coloré  
Feinsteinzeug



Size Formato	Finishes Finiture	Price code sqm Codice prezzo m <sup>2</sup>	
 <b>EKTREME</b> <b>120x280</b> 48"x110" → 6 mm	Rectified Rettificato	159	•
	High Gloss LCP Lappato campo pieno	166	•
 <b>120x120</b> 48"x48" → 9 mm	Rectified Rettificato	153	•
	High Gloss LCP Lappato campo pieno	160	•
 <b>60x120</b> 24"x48" → 9 mm	Rectified Rettificato	146	•
	High Gloss LCP Lappato campo pieno	153	•
 <b>BATTISCOPA</b> <b>6,5x120</b> 2 1/4"x48"	Rectified Rettificato	120 *	
	High Gloss LCP Lappato campo pieno	127 *	

TOP SOLUTION available\_see related catalog • Price code / pc. Codice prezzo / pz.  
 TOP SOLUTION disponibile\_consulta il catalogo

## Mosaics.

Mosaici. Mosaiques. Mosaik.



MOSAICO ESAGONI  
26x30 10"x12"  
LCP

Price code / pc.  
Codice prezzo / pz.  
128



# Makrana

Majestic inspiration



WALL Makrana 120x280 - 48"x110"



**R9**  
Rectified  
Rettificato  
Rektifiziert

**High gloss LCP**  
Lappato campo pieno  
Semi-poli brillant  
Hochglanz Lappato

**Porcelain stoneware**  
Gres porcellanato  
Grès cérame coloré  
Feinsteinzeug



Size Formato	Finishes Finiture	Price code sqm Codice prezzo m <sup>2</sup>	
 <b>EKTREME</b> <b>120x280</b> 48"x110" → 6 mm	Rectified Rettificato	159	•
	High Gloss LCP Lappato campo pieno	166	•
 <b>120x120</b> 48"x48" → 9 mm	Rectified Rettificato	153	•
	High Gloss LCP Lappato campo pieno	160	•
 <b>60x120</b> 24"x48" → 9 mm	Rectified Rettificato	146	•
	High Gloss LCP Lappato campo pieno	153	•
 <b>BATTISCOPA</b> <b>6,5x120</b> 2 1/4"x48"	Rectified Rettificato	120 *	•
	High Gloss LCP Lappato campo pieno	127 *	•

\* Price code / pc. Codice prezzo / pz.

General index

Product indexes

The Company

## Collections

Marble Look  
Concrete Look  
Stone Look  
Metal Look  
Wood Look  
Cotto Look



TH2.0  
Outdoor  
Solutions

Bathroom  
furniture

Ventilated  
facades

Technical  
information

# Marquiña

The beauty of contrasts



WALL White 120x280 . 48" x110" | Mosaico Double Exa 19,5x25,4 . 8" x10"  
FURNITURE White 120x280 . 48" x110"  
FLOOR White 60x120 . 24" x48"



White



Black

General index

Product indexes

The Company

### Collections

- Marble Look
- Concrete Look
- Stone Look
- Metal Look
- Wood Look
- Cotto Look



TH2.0  
Outdoor  
Solutions

Bathroom  
furniture

Ventilated  
facades

Technical  
information

# Marquiña

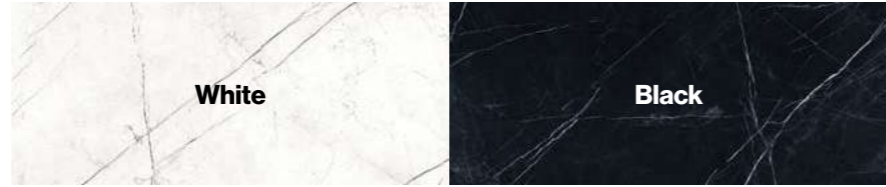

Size Formato	Finishes Finiture	Price code sqm Codice prezzo m <sup>2</sup>	Price code sqm Codice prezzo m <sup>2</sup>
<b>EKTREME</b> <b>120x280</b> 48"x110" → 6 mm	Rectified Rettificato	● 159	● 161
	High Gloss LCP Lappato campo pieno	● 166	● 167
<b>120x120</b> 48"x48" → 9 mm	Rectified Rettificato	● 153	● 155
	High Gloss LCP Lappato campo pieno	● 160	● 162
<b>60x120</b> 24"x48" → 9 mm	Rectified Rettificato	● 146	● 148
	High Gloss LCP Lappato campo pieno	● 153	● 155
<b>60x60</b> 24"x24" → 9 mm	Rectified Rettificato	● 140	● 141
	High Gloss LCP Lappato campo pieno	● 149	● 150
<b>BATTISCOPA</b> <b>6,5x120</b> 2 1/8"x48"	Rectified Rettificato	● 120 *	● 120 *
	High Gloss LCP Lappato campo pieno	● 127 *	● 127 *
<b>BATTISCOPA</b> <b>7,5x60</b> 3"x24"	Rectified Rettificato	● 106 *	● 106 *
	High Gloss LCP Lappato campo pieno	● 107 *	● 107 *

TOP SOLUTION available\_ see related catalog • Price code / pc. Codice prezzo / pz.  
 TOP SOLUTION disponibile\_ consulta il catalogo



WALL Mosaico Double Exa 19,5x25,4 . 8"x10"

**R9**  
 Rectified  
 Rettificato  
 Rectifié  
 Rektifiziert

**V2**

**High gloss LCP**  
 Lappato campo pieno  
 Semi-poli brillant  
 Hochglanz Lappato

**Porcelain stoneware**  
 Gres porcellanato  
 Grès cérame coloré  
 Feinsteinzeug

## Mosaics.

Mosaici. Mosaiques. Mosaik.



White  
 MOSAICO 36PZ  
 30x30 12"x12"  
 LCP  
 -  
 30x30 12"x12"  
 NAT  
 Price code / pc  
 Codice prezzo / pz  
**LCP 117**  
**NAT 110**



White  
 MOSAICO ESAGONI  
 26x30 10"x12"  
 LCP  
 -  
 26x30 10"x12"  
 NAT  
 Price code / pc  
 Codice prezzo / pz  
**LCP 128**  
**NAT 122**

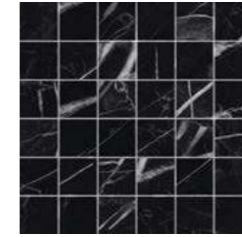

Black  
 MOSAICO 36PZ  
 30x30 12"x12"  
 LCP  
 -  
 30x30 12"x12"  
 NAT  
 Price code / pc  
 Codice prezzo / pz  
**LCP 117**  
**NAT 110**



Black  
 MOSAICO ESAGONI  
 26x30 10"x12"  
 LCP  
 -  
 26x30 10"x12"  
 NAT  
 Price code / pc  
 Codice prezzo / pz  
**LCP 128**  
**NAT 122**

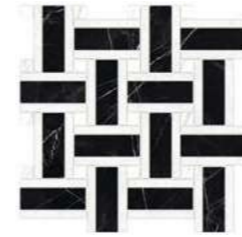

MOSAICO BASKET  
 30x30 12"x12"  
 LCP  
 Price code / pc  
 Codice prezzo / pz  
**126**



MOSAICO DOUBLE EXA  
 19,5x25,4 8"x10"  
 LCP  
 Price code / pc  
 Codice prezzo / pz  
**138**



General  
 index

Product  
 indexes

The  
 Company

## Collections

Marble Look  
 Concrete Look  
 Stone Look  
 Metal Look  
 Wood Look  
 Cotto Look



TH2.0  
 Outdoor  
 Solutions

Bathroom  
 furniture

Ventilated  
 facades

Technical  
 information

# Navona

Icon of natural beauty



WALL **Soft Niveo** 120x280 . 48"x110"  
FURNITURE **Vein Niveo** 120x280 . 48"x110"



**Soft Niveo**

**Vein Niveo**

**Soft Candido**

**Vein Candido**

**Soft Aureo**

**Vein Aureo**

**Soft Nebulo**

**Vein Nebulo**

General index

Product indexes

The Company

**Collections**  
Marble Look  
Concrete Look  
Stone Look  
Metal Look  
Wood Look  
Cotto Look



TH2.0  
Outdoor Solutions

Bathroom furniture

Ventilated facades

Technical information



Size Formato	Finishes Finiture	Price code sqm Codice prezzo m <sup>2</sup>	•	•	•	•
<b>EKTREME</b> <b>120x280</b> 48"x110" ⇒ 6 mm	Rectified Rettificato	<b>162</b>	•	•	•	•
<b>120x120</b> 48"x48" ⇒ 9 mm	Rectified Rettificato	<b>155</b>	•	•	•	•
<b>60x120</b> 24"x48" ⇒ 9 mm	Rectified Rettificato	<b>146</b>	•	•	•	•
<b>60x60</b> 24"x24" ⇒ 9 mm	Rectified Rettificato	<b>141</b>	•	•	•	•
	Antislip Sabbiato	<b>143</b>	•	•	•	•
<b>30x60</b> 12"x24" ⇒ 9 mm	Rectified Rettificato	<b>139</b>	•	•	•	•
<b>BATTISCOPA</b> <b>6,5x120</b> 2 1/8"x48"	Rectified Rettificato	<b>120*</b>	•	•	•	•
<b>BATTISCOPA</b> <b>7,5x60</b> 3"x24"	Rectified Rettificato	<b>106*</b>	•	•	•	•

TH2.0 OUTDOOR SOLUTIONS available   
TH2.0 OUTDOOR SOLUTIONS disponibile

\* Price code / pc. Codice prezzo / pz.

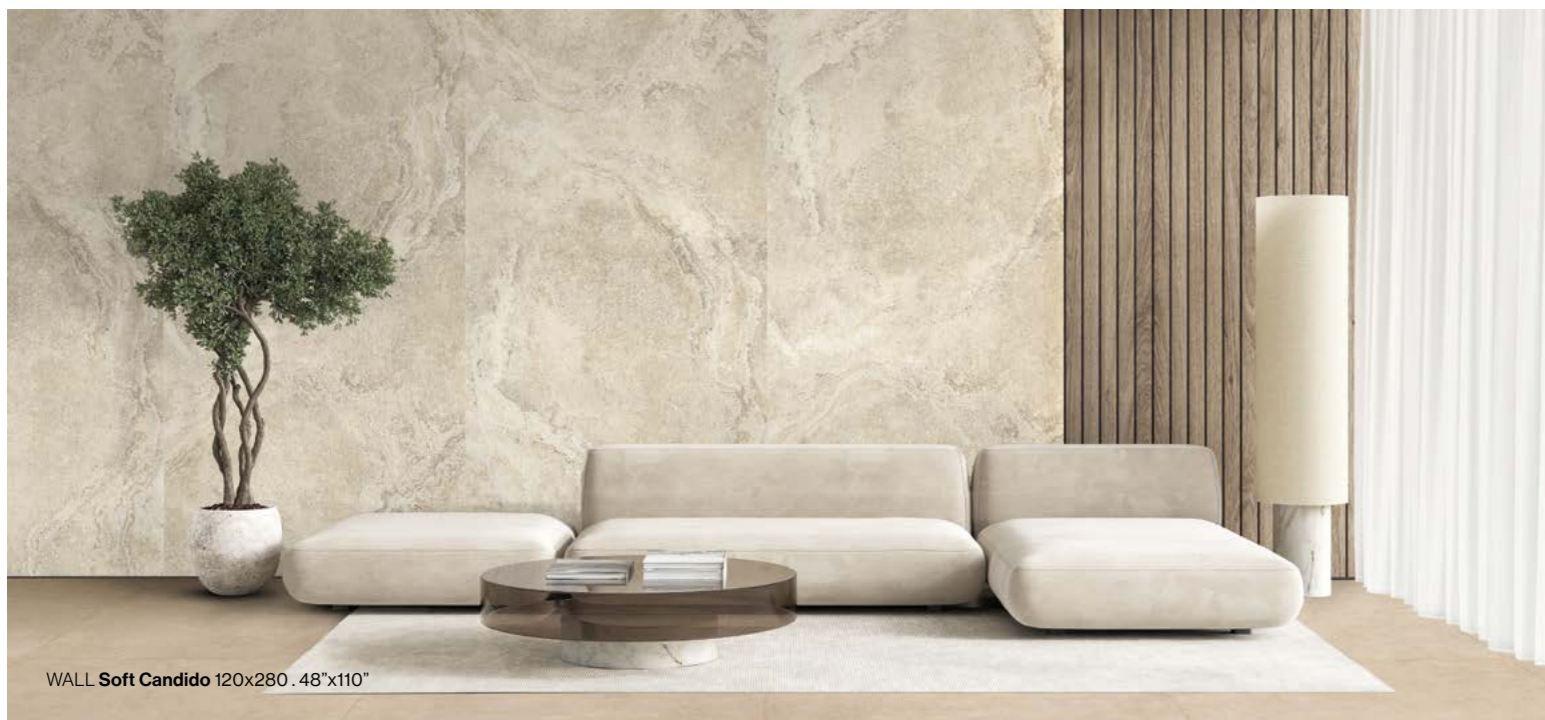

WALL Soft Candido 120x280 . 48"x110"

## Mosaics.

Mosaici. Mosaïques. Mosaik.

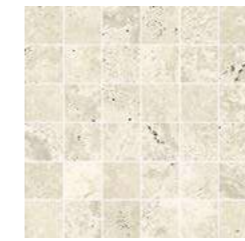

Soft Niveo  
MOSAICO 36PZ  
30x30 12"x12"  
NAT  
Price code / pc  
Codice prezzo / pz  
**110**

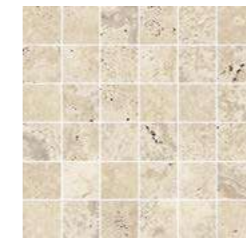

Soft Candido  
MOSAICO 36PZ  
30x30 12"x12"  
NAT  
Price code / pc  
Codice prezzo / pz  
**110**



Soft Aureo  
MOSAICO 36PZ  
30x30 12"x12"  
NAT  
Price code / pc  
Codice prezzo / pz  
**110**



Soft Nebulo  
MOSAICO 36PZ  
30x30 12"x12"  
NAT  
Price code / pc  
Codice prezzo / pz  
**110**



Soft Niveo  
MOSAICO MURETTO ANTICATO  
30x30 12"x12"  
NAT  
Price code / pc  
Codice prezzo / pz  
**115**



Soft Candido  
MOSAICO MURETTO ANTICATO  
30x30 12"x12"  
NAT  
Price code / pc  
Codice prezzo / pz  
**115**



Soft Aureo  
MOSAICO MURETTO ANTICATO  
30x30 12"x12"  
NAT  
Price code / pc  
Codice prezzo / pz  
**115**



Soft Nebulo  
MOSAICO MURETTO ANTICATO  
30x30 12"x12"  
NAT  
Price code / pc  
Codice prezzo / pz  
**115**



Soft Niveo  
MOSAICO HERRINGBONE  
33,5x33,5 13"x13"  
NAT  
Price code / pc  
Codice prezzo / pz  
**121**



Soft Candido  
MOSAICO HERRINGBONE  
33,5x33,5 13"x13"  
NAT  
Price code / pc  
Codice prezzo / pz  
**121**



Soft Aureo  
MOSAICO HERRINGBONE  
33,5x33,5 13"x13"  
NAT  
Price code / pc  
Codice prezzo / pz  
**121**



Soft Nebulo  
MOSAICO HERRINGBONE  
33,5x33,5 13"x13"  
NAT  
Price code / pc  
Codice prezzo / pz  
**121**



# Navona Vein

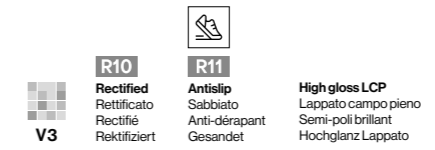

**Porcelain stoneware coloured in body**  
Gres porcellanato colorato in massa  
Grès cérame coloré dans la masse  
Eingefärbtes Feinsteinzeug



Size Formato	Finishes Finiture	Price code sqm Codice prezzo m <sup>2</sup>	•	•	•	•
	<b>EKTREME</b> 120x280 48"x110" ±6 mm	Rectified Rettificato	162	•	•	•
	High Gloss LCP Lappato campo pieno	166	•	•	•	•
	<b>80x160</b> 32"x63" ±9 mm	Rectified Rettificato	150	•	•	
	<b>120x120</b> 48"x48" ±9 mm	Rectified Rettificato	155	•	•	•
	<b>60x120</b> 24"x48" ±9 mm	Rectified Rettificato	146	•	•	•
	Antislip Sabbiato	149	•	•	•	•
	<b>60x120</b> 24"x48" ±9 mm	High Gloss LCP Lappato campo pieno	153	•	•	•
	<b>60x60</b> 24"x24" ±9 mm	Rectified Rettificato	141	•	•	•
	<b>30x60</b> 12"x24" ±9 mm	Rectified Rettificato	139	•	•	•
	<b>FLOW</b> 60x120 24"x48" ±9 mm	Rectified Rettificato	151	•	•	•
	<b>BATTISCOPA</b> 6,5x120 2 1/8"x48"	Rectified Rettificato	120*	•	•	•

TOP SOLUTION available\_see related catalog  TH2.0 OUTDOOR SOLUTIONS available  \* Price code / pc. Codice prezzo / pz.  
TOP SOLUTION disponibile\_consulta il catalogo  TH2.0 OUTDOOR SOLUTIONS disponibile

**3D Flow texture.**  
Struttura 3D Flow. Structure 3D Flow. 3D Flow Textur.



Vein Candido  
FLOW  
60x120 24"x48"  
±9 mm  
RETT

**Mosaics.**  
Mosaici. Mosaïques. Mosaik.



Vein Niveo  
MOSAICO ESAGONI  
26x30 10"x12"  
LCP  
Price code / pc  
Codice prezzo / pz  
128



Vein Candido  
MOSAICO ESAGONI  
26x30 10"x12"  
LCP  
Price code / pc  
Codice prezzo / pz  
128



Vein Aureo  
MOSAICO ESAGONI  
26x30 10"x12"  
LCP  
Price code / pc  
Codice prezzo / pz  
128



Vein Nebulo  
MOSAICO ESAGONI  
26x30 10"x12"  
LCP  
Price code / pc  
Codice prezzo / pz  
128



Marble Look Navona

General index

Product indexes

The Company

Collections

Marble Look  
Concrete Look  
Stone Look  
Metal Look  
Wood Look  
Cotto Look



TH2.0  
Outdoor  
Solutions

Bathroom  
furniture

Ventilated  
facades

Technical  
information

# Onyx

Graceful marble palette



FLOOR Grey 120x120 - 48"x48"

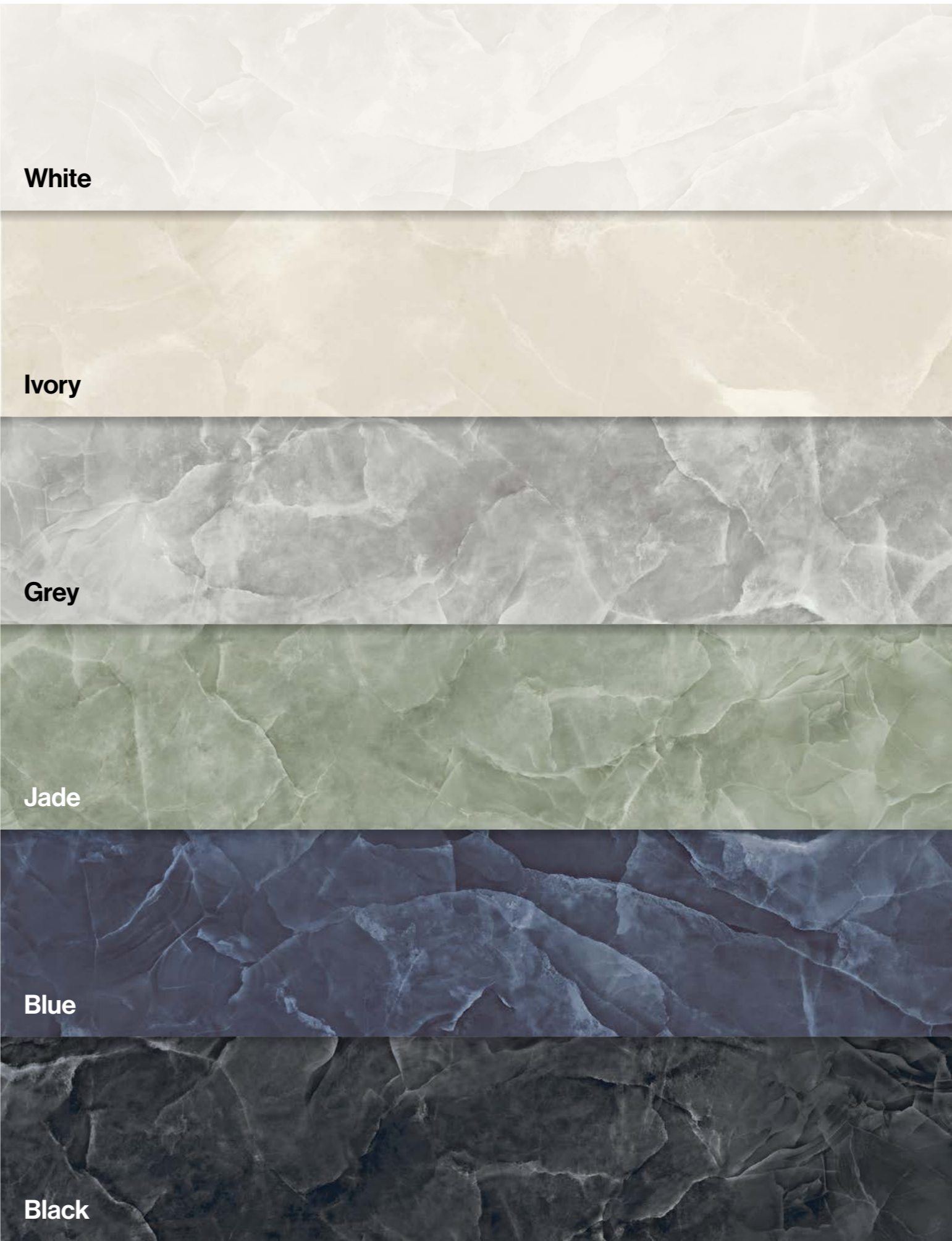

White

Ivory

Grey

Jade

Blue

Black

General index

Product indexes

The Company

### Collections

- Marble Look
- Concrete Look
- Stone Look
- Metal Look
- Wood Look
- Cotto Look



TH2.0  
Outdoor  
Solutions

Bathroom  
furniture

Ventilated  
facades

Technical  
information





Size Formato	Finishes Finiture	White	Ivory	Grey	Jade	Blue	Black
		Price code sqm Codice prezzo m <sup>2</sup>	Price code sqm Codice prezzo m <sup>2</sup>	Price code sqm Codice prezzo m <sup>2</sup>	Price code sqm Codice prezzo m <sup>2</sup>	Price code sqm Codice prezzo m <sup>2</sup>	Price code sqm Codice prezzo m <sup>2</sup>
<b>EKXTREME</b> 120x280 48"x110" → 6 mm	High Gloss LCP Lappato campo pieno	● 166	● 166	● 166	● 166	● 167	● 167
<b>80x160</b> 32"x63" → 9 mm	High Gloss LCP Lappato campo pieno	● 162		● 162		● 163	
<b>120x120</b> 48"x48" → 9 mm	High Gloss LCP Lappato campo pieno	● 160	● 160	● 160	● 160	● 162	● 162
<b>60x120</b> 24"x48" → 9 mm	Rectified Rettificato	● 146	● 146	● 146			
	High Gloss LCP Lappato campo pieno	● 153	● 153	● 153	● 153	● 155	● 155
<b>80x80</b> 32"x32" → 9 mm	High Gloss LCP Lappato campo pieno	● 157		● 157		● 157	
<b>60x60</b> 24"x24" → 9 mm	High Gloss LCP Lappato campo pieno	● 149		● 149	● 149	● 150	● 150
<b>30x60</b> 12"x24" → 9 mm	High Gloss LCP Lappato campo pieno	● 149		● 149	● 149	● 150	● 150
<b>BATTISCOPA</b> <b>6,5x120</b> 2 7/8"x48"	High Gloss LCP Lappato campo pieno	● 127*	● 127*	● 127*	● 127*	● 127*	● 127*
<b>BATTISCOPA</b> <b>7,5x60</b> 3"x24"	High Gloss LCP Lappato campo pieno	● 107*		● 107*	● 107*	● 107*	● 107*

\* Price code / pc. Codice prezzo / pz.





## Mosaics.

Mosaici. Mosaiques. Mosaik.



White  
 MOSAICO 36PZ  
 30x30 12"x12"  
 LCP

Price code / pc  
 Codice prezzo / pz  
**117**



White  
 MOSAICO ESAGONI  
 26x30 10"x12"  
 LCP

Price code / pc  
 Codice prezzo / pz  
**128**



Ivory  
 MOSAICO 36PZ  
 30x30 12"x12"  
 LCP

Price code / pc  
 Codice prezzo / pz  
**117**



Ivory  
 MOSAICO ESAGONI  
 26x30 10"x12"  
 LCP

Price code / pc  
 Codice prezzo / pz  
**128**

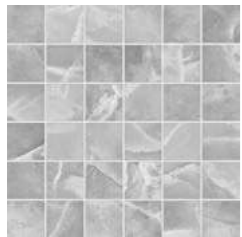

Grey  
 MOSAICO 36PZ  
 30x30 12"x12"  
 LCP

Price code / pc  
 Codice prezzo / pz  
**117**



Grey  
 MOSAICO ESAGONI  
 26x30 10"x12"  
 LCP

Price code / pc  
 Codice prezzo / pz  
**128**



Jade  
 MOSAICO 36PZ  
 30x30 12"x12"  
 LCP

Price code / pc  
 Codice prezzo / pz  
**117**



Jade  
 MOSAICO ESAGONI  
 26x30 10"x12"  
 LCP

Price code / pc  
 Codice prezzo / pz  
**128**



Blue  
 MOSAICO 36PZ  
 30x30 12"x12"  
 LCP

Price code / pc  
 Codice prezzo / pz  
**117**



Blue  
 MOSAICO ESAGONI  
 26x30 10"x12"  
 LCP

Price code / pc  
 Codice prezzo / pz  
**128**

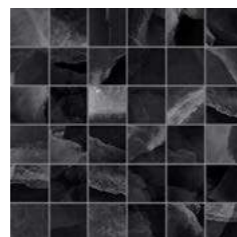

Black  
 MOSAICO 36PZ  
 30x30 12"x12"  
 LCP

Price code / pc  
 Codice prezzo / pz  
**117**



Black  
 MOSAICO ESAGONI  
 26x30 10"x12"  
 LCP

Price code / pc  
 Codice prezzo / pz  
**128**



WALL Jade 120x280 . 48"x110" | White 120x280 . 48"x110" | Jade Mosaico Esagoni 26x30 . 10"x12"  
 FURNITURE Jade 120x280 . 48"x110" | White 120x280 . 48"x110"  
 FLOOR Jade 120x280 . 48"x110"

# Patagonia

Elegance beyond ordinary







WALL **Patagonia** 120x280 . 48"x110"  
 FURNITURE **Patagonia** 163x324 . 64"x127" TOP SOLUTION  
 FLOOR **Res-Terrae. Cotton** 120x120 . 48"x48"

**V3**  
 High gloss LCP  
 Lappato campo pieno  
 Semi-poli brillante  
 Hochglanz Lappato

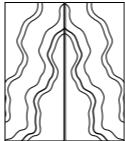
**Porcelain stoneware coloured in body**  
 Gres porcellanato colorato in massa  
 Grès cérame coloré dans la masse  
 Eingefärbtes Feinsteinzeug



Size Formato	Finishes Finiture	Price code sqm Codice prezzo m <sup>2</sup>
 <b>EKTREME</b> <b>120x280</b> 48"x110" → 6 mm	High Gloss LCP Lappato campo pieno	166
 <b>EKTREME</b> <b>BOOKMATCH</b> <b>120x280</b> 48"x110" → 6 mm	High Gloss LCP Lappato campo pieno	170
 <b>120x120</b> 48"x48" → 9 mm	High Gloss LCP Lappato campo pieno	160
 <b>60x120</b> 24"x48" → 9 mm	High Gloss LCP Lappato campo pieno	153
 <b>BATTISCOPIA</b> <b>6,5x120</b> 2 1/4"x48"	High Gloss LCP Lappato campo pieno	127 * 

TOP SOLUTION available\_ see related catalog  • Price code / pc. Codice prezzo / pz.  
 TOP SOLUTION disponibile\_ consulta il catalogo

## Mosaics.

Mosaici. Mosaiques. Mosaik.

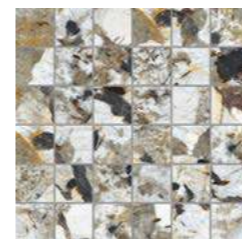

**MOSAICO 36PZ**  
**30x30 12"x12"**  
**LCP**  
 Price code / pc  
 Codice prezzo / pz  
**117**



**MOSAICO ESAGONI**  
**26x30 10"x12"**  
**LCP**  
 Price code / pc  
 Codice prezzo / pz  
**128**



## Bookmatch.



Composition 1



Composition 2



Composition 3

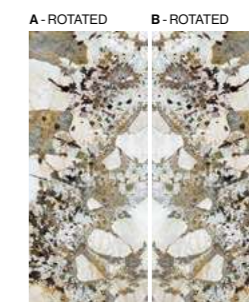

Composition 4

The image shown is for illustrative purposes only. As with natural marble slabs, Bookmatch patterns may present vein discontinuities between one slab and another. For this reason, differences of up to 1.5 cm are to be considered normal product characteristics. L'immagine rappresentata è a puro scopo illustrativo. Come per le lastre di marmo naturale, anche le grafiche Bookmatch possono presentare discontinuità tra una lastra e l'altra. Per questa ragione, differenze fino a 1,5 cm sono da considerarsi normali caratteristiche del prodotto.

# Pierre Black

Unmatched sophistication



WALL Pierre Black 120x280 - 48"x110"  
FLOOR Woodbreak, Ebony 20x160 - 8"x63"





**R9**  
Rectified  
Rettificato  
Rectifié  
Rektifiziert

**V2**

**High gloss LCP**  
Lappato campo pieno  
Semi-poli brillant  
Hochglanz Lappato

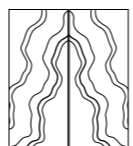
**Porcelain stoneware coloured in body**  
Gres porcellanato colorato in massa  
Grès cérame coloré dans la masse  
Eingefärbtes Feinsteinzeug

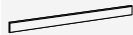

Size Formato	Finishes Finiture	Price code sqm Codice prezzo m²
 <b>EKXTREME</b> <b>120x280</b> 48"x110" → 6 mm	Rectified Rettificato	161
	High Gloss LCP Lappato campo pieno	167
 <b>EKXTREME</b> <b>BOOKMATCH</b> <b>120x280</b> 48"x110" → 6 mm	High Gloss LCP Lappato campo pieno	171
 <b>120x120</b> 48"x48" → 9 mm	High Gloss LCP Lappato campo pieno	162
 <b>60x120</b> 24"x48" → 9 mm	Rectified Rettificato	148
	High Gloss LCP Lappato campo pieno	155
 <b>BATTISCOPIA</b> <b>6,5x120</b> 2 1/8"x48"	High Gloss LCP Lappato campo pieno	127 * 

\* Price code / pc. Codice prezzo / pz.

## Mosaics.

Mosaici. Mosaiques. Mosaik.

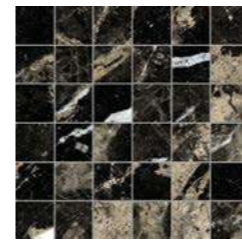

MOSAICO 36PZ  
30x30 12"x12"  
LCP

Price code / pc  
Codice prezzo / pz  
117



MOSAICO ESAGONI  
26x30 10"x12"  
LCP

Price code / pc  
Codice prezzo / pz  
128



## Bookmatch.

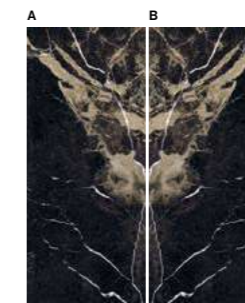

Composition 1

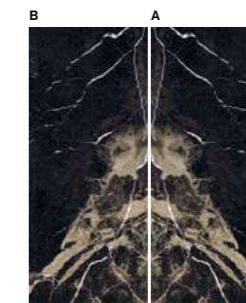

Composition 2

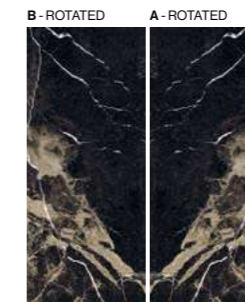

Composition 3

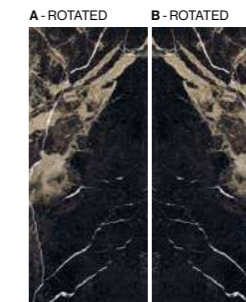

Composition 4

The image shown is for illustrative purposes only. As with natural marble slabs, Bookmatch patterns may present vein discontinuities between one slab and another. For this reason, differences of up to 1.5 cm are to be considered normal product characteristics. L'immagine rappresentata è a puro scopo illustrativo. Come per le lastre di marmo naturale, anche le grafiche Bookmatch possono presentare discontinuità tra una lastra e l'altra. Per questa ragione, differenze fino a 1,5 cm sono da considerarsi normali caratteristiche del prodotto.

# Pietragrey

Grey tones for modern harmony



WALL Calacatta Cenerino 120x280 . 48"x110"  
 FURNITURE Calacatta Cenerino 120x280 . 48"x110"  
 FLOOR Taupe 120x120 . 48"x48"



White



Taupe



Fog

General index

Product indexes

The Company

### Collections

- Marble Look
- Concrete Look
- Stone Look
- Metal Look
- Wood Look
- Cotto Look



TH2.0 Outdoor Solutions

Bathroom furniture

Ventilated facades

Technical information

# Pietragrey



WALL **Taupe** 60x120 . 24"x48" | **White** 60x120 . 24"x48"  
 FLOOR **Corsocomo. Meringue** 120x120 . 48"x48"

**R9**  
 Rectified  
 Rettificato  
 Rectifié  
 Rektifiziert  
**V2**

**High gloss LCP**  
 Lappato campo pieno  
 Semi-poli brillant  
 Hochglanz Lappato

**Porcelain stoneware coloured in body**  
 Gres porcellanato colorato in massa  
 Grès cérame coloré dans la masse  
 Eingefärbtes Feinsteinzeug



Size Formato	Finishes Finiture	Price code sqm Codice prezzo m <sup>2</sup>	White	Taupe	Fog
 <b>120x120</b> 48"x48" →9 mm	<b>Rectified</b> Rettificato	<b>153</b>	•	•	•
	<b>High Gloss LCP</b> Lappato campo pieno	<b>160</b>	•	•	•
 <b>60x120</b> 24"x48" →9 mm	<b>Rectified</b> Rettificato	<b>146</b>	•	•	•
	<b>High Gloss LCP</b> Lappato campo pieno	<b>153</b>	•	•	•
 <b>60x60</b> 24"x24" →9 mm	<b>Rectified</b> Rettificato	<b>139</b>	•	•	•
	<b>High Gloss LCP</b> Lappato campo pieno	<b>149</b>	•	•	•
 BATTISCOPA <b>6,5x120</b> 2 1/4"x48"	<b>Rectified</b> Rettificato	<b>120*</b>	•	•	•
 BATTISCOPA <b>7,5x60</b> 3"x24"	<b>High Gloss LCP</b> Lappato campo pieno	<b>107*</b>	•	•	•

\* Price code / pc. Codice prezzo / pz.

## Mosaics.

Mosaici. Mosaiques. Mosaik.



White  
 MOSAICO 36PZ  
 30x30 12"x12"  
 NAT

Price code / pc  
 Codice prezzo / pz  
**110**



Taupe  
 MOSAICO 36PZ  
 30x30 12"x12"  
 NAT

Price code / pc  
 Codice prezzo / pz  
**110**

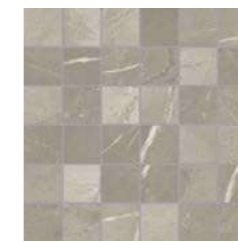

Fog  
 MOSAICO 36PZ  
 30x30 12"x12"  
 NAT

Price code / pc  
 Codice prezzo / pz  
**110**



# Sahara Noir

Forever refined

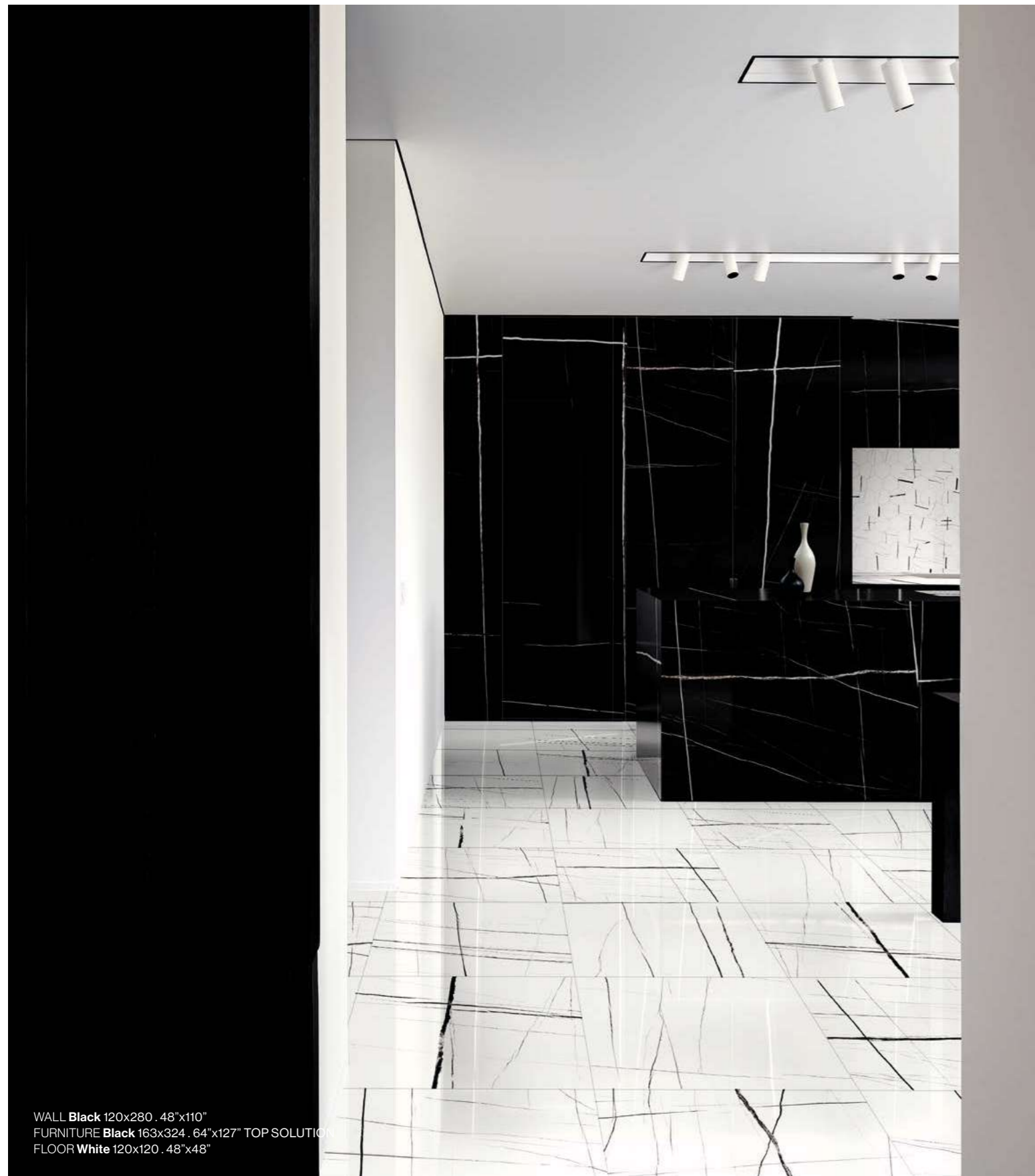

WALL **Black** 120x280 .48"x110"  
FURNITURE **Black** 163x324 .64"x127" TOP SOLUTION  
FLOOR **White** 120x120 .48"x48"

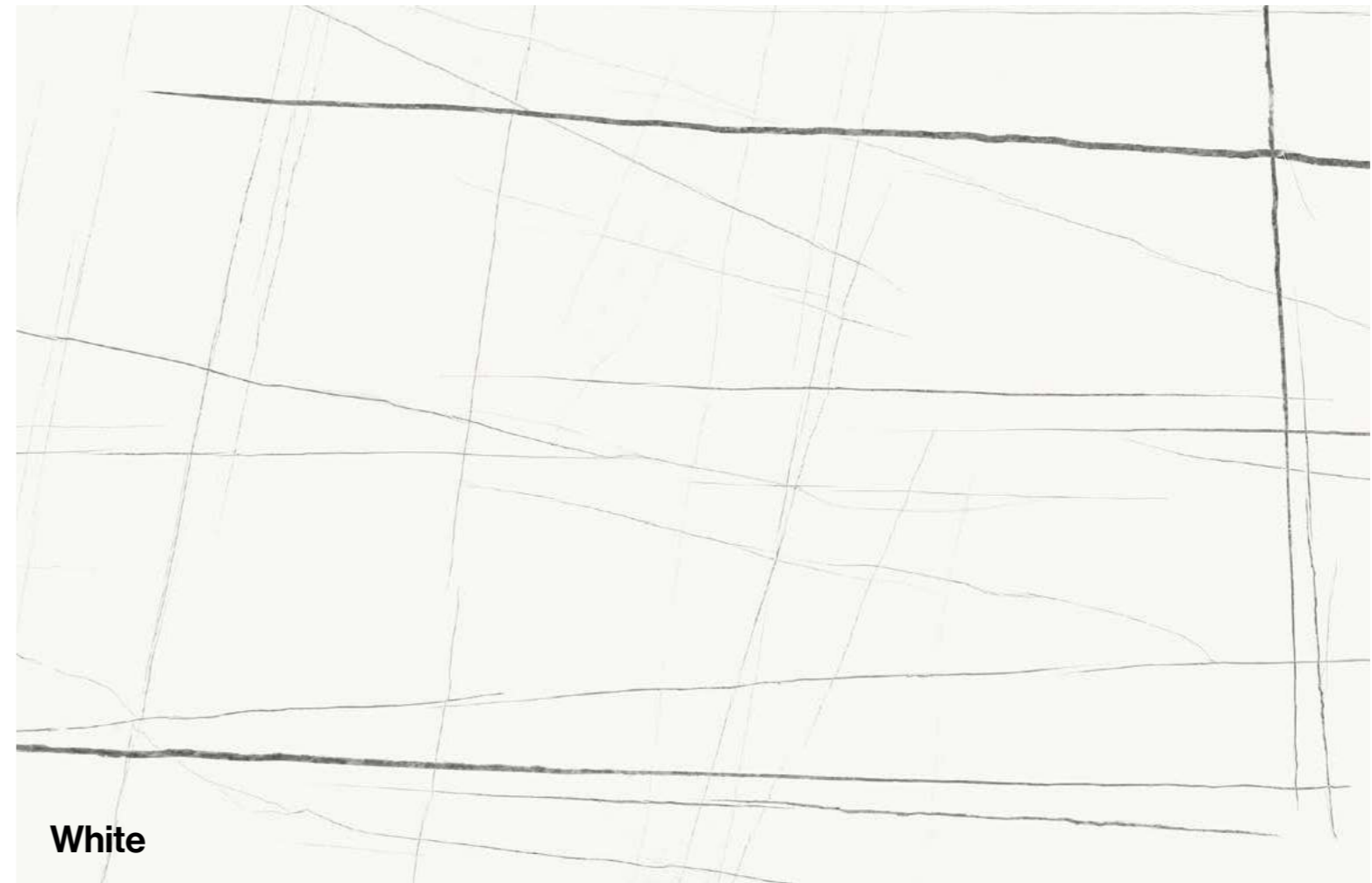

White



Black

General index

Product indexes

The Company

## Collections

Marble Look  
Concrete Look  
Stone Look  
Metal Look  
Wood Look  
Cotto Look



TH2.0  
Outdoor  
Solutions

Bathroom  
furniture

Ventilated  
facades

Technical  
information

# Sahara Noir



WALL White 120x280 . 48"x110"  
BATHROOM FURNITURE White





**R9**  
Rectified  
Rettificato  
Rectifié  
Rektifiziert

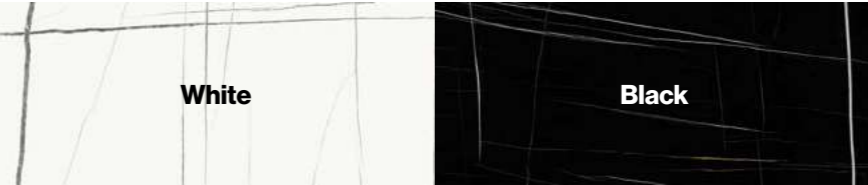

**V2**

**High gloss LCP**  
Lappato campo pieno  
Semi-poli brillant  
Hochglanz Lappato

**Porcelain stoneware**  
Gres porcellanato  
Grès cérame coloré  
Feinsteinzeug



Size Formato	Finishes Finiture	Price code sqm Codice prezzo m <sup>2</sup>	Price code sqm Codice prezzo m <sup>2</sup>
 <b>EKTREME</b> 120x280 48"x110" → 6 mm	Rectified Rettificato	● 159	● 161
	High Gloss LCP Lappato campo pieno	● 166	● 167
 <b>120x120</b> 48"x48" → 9 mm	Rectified Rettificato	● 153	● 155
	High Gloss LCP Lappato campo pieno	● 160	● 162
 <b>60x120</b> 24"x48" → 9 mm	Rectified Rettificato	● 146	● 148
	High Gloss LCP Lappato campo pieno	● 153	● 155
 <b>BATTISCOPA</b> 6,5x120 2 1/4"x48"	Rectified Rettificato	● 120*	● 120*
	High Gloss LCP Lappato campo pieno	● 127*	● 127*

TOP SOLUTION available\_see related catalog  • Price code / pc. Codice prezzo / pz.  
TOP SOLUTION disponibile\_consulta il catalogo 

### Mosaics.

Mosaici. Mosaiques. Mosaik.



White  
MOSAICO 36PZ  
30x30 12"x12"  
LCP  
-  
30x30 12"x12"  
NAT  
Price code / pc  
Codice prezzo / pz  
**LCP 117**  
**NAT 110**

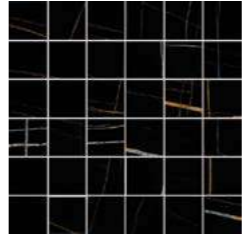

White  
MOSAICO ESAGONI  
26x30 10"x12"  
NAT  
Price code / pc  
Codice prezzo / pz  
**122**

Black  
MOSAICO 36PZ  
30x30 12"x12"  
LCP  
-  
30x30 12"x12"  
NAT  
Price code / pc  
Codice prezzo / pz  
**LCP 117**  
**NAT 110**



Black  
MOSAICO ESAGONI  
26x30 10"x12"  
NAT  
Price code / pc  
Codice prezzo / pz  
**122**



General index

Product indexes

The Company

**Collections**  
Marble Look  
Concrete Look  
Stone Look  
Metal Look  
Wood Look  
Cotto Look

TH2.0  
Outdoor  
Solutions

Bathroom  
furniture

Ventilated  
facades

Technical  
information



# Statuario Superiore

The art of pure white



WALL Statuario Superiore 120x280 . 48"x110" | Agathòs. Multicolor 120x280 . 48"x110"  
FURNITURE Agathòs. Multicolor 120x280 . 48"x110"  
FLOOR Statuario Superiore 120x120 . 48"x48"



FLOOR Statuario Superiore 60x120 . 24"x48"

General index

Product indexes

The Company

## Collections

Marble Look  
Concrete Look  
Stone Look  
Metal Look  
Wood Look  
Cotto Look



TH2.0  
Outdoor  
Solutions

Bathroom  
furniture

Ventilated  
facades

Technical  
information

# Statuario Superiore



**R9**  
Rectified  
Rettificato  
Rectifié  
Rektifiziert

**High gloss LCP**  
Lappato campo pieno  
Semi-poli brillant  
Hochglanz Lappato

**Porcelain stoneware**  
Gres porcellanato  
Grès cérame coloré  
Feinsteinzeug



Size Formato	Finishes Finiture	Price code sqm Codice prezzo m <sup>2</sup>	
<b>EKTREME</b> <b>120x280</b> 48"x110" → 6 mm	Rectified Rettificato	159	●
	High Gloss LCP Lappato campo pieno	166	●
<b>EKTREME</b> <b>BOOKMATCH</b> <b>120x280</b> 48"x110" → 6 mm	High Gloss LCP Lappato campo pieno	170	●
<b>120x120</b> 48"x48" → 9 mm	Rectified Rettificato	153	●
	High Gloss LCP Lappato campo pieno	160	●
<b>60x120</b> 24"x48" → 9 mm	Rectified Rettificato	146	●
	High Gloss LCP Lappato campo pieno	153	●
<b>60x60</b> 24"x24" → 9 mm	Rectified Rettificato	140	●
	High Gloss LCP Lappato campo pieno	149	●
<b>30x60</b> 12"x24" → 9 mm	Rectified Rettificato	137	●
	High Gloss LCP Lappato campo pieno	149	●
<b>FLOW</b> <b>60x120</b> 24"x48" → 9 mm	Rectified Rettificato	151	●
<b>BATTISCOPA</b> <b>6,5x120</b> 2 1/8"x48"	High Gloss LCP Lappato campo pieno	127 *	●
<b>BATTISCOPA</b> <b>7,5x60</b> 3"x24"	High Gloss LCP Lappato campo pieno	107 *	●

TOP SOLUTION available\_see related catalog • Price code / pc. Codice prezzo / pz.  
TOP SOLUTION disponibile\_consulta il catalogo

## 3D Flow texture.

Struttura 3D Flow. Structure 3D Flow. 3D Flow Textur.



FLOW  
60x120 24"x48"  
→ 9 mm  
RETT

## Mosaics.

Mosaici. Mosaiques. Mosaik.



MOSAICO ESAGONI  
26x30 10"x12"  
LCP  
-  
26x30 10"x12"  
NAT

Price code / pc  
Codice prezzo / pz  
LCP 128  
NAT 122



## Bookmatch.

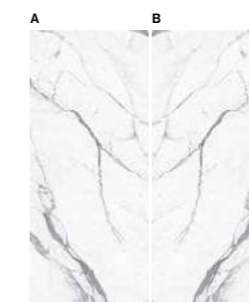

Composition 1

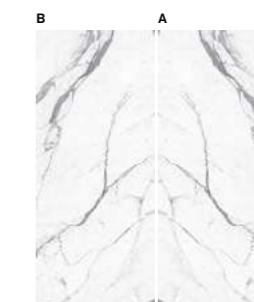

Composition 2

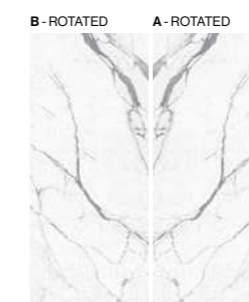

Composition 3

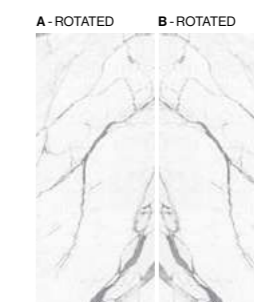

Composition 4

The image shown is for illustrative purposes only. As with natural marble slabs, Bookmatch patterns may present vein discontinuities between one slab and another. For this reason, differences of up to 1.5 cm are to be considered normal product characteristics. L'immagine rappresentata è a puro scopo illustrativo. Come per le lastre di marmo naturale, anche le grafiche Bookmatch possono presentare discontinuità tra una lastra e l'altra. Per questa ragione, differenze fino a 1,5 cm sono da considerarsi normali caratteristiche del prodotto.

General  
index

Product  
indexes

The  
Company

## Collections

Marble Look  
Concrete Look  
Stone Look  
Metal Look  
Wood Look  
Cotto Look



TH2.0  
Outdoor  
Solutions

Bathroom  
furniture

Ventilated  
facades

Technical  
information

# Taj Mahal

Graceful simplicity



WALL Amber 120x280 . 48"x110"  
FLOOR Amber 120x280 . 48"x110"



**R9**  
Rectified  
Rettificato  
Rectifié  
Rektifiziert

**High gloss LCP**  
Lappato campo pieno  
Semi-poli brillant  
Hochglanz Lappato

**Porcelain stoneware**  
Gres porcellanato  
Grès cérame coloré  
Feinsteinzeug



Size Formato	Finishes Finiture	Price code sqm Codice prezzo m <sup>2</sup>	Shell	Linen	Amber
 <b>EKTREME</b> 120x280 48"x110" ±6 mm	Rectified Rettificato	159	•	•	•
	High Gloss LCP Lappato campo pieno	166	•	•	•
 <b>120x120</b> 48"x48" ±9 mm	Rectified Rettificato	153	•	•	•
 <b>60x120</b> 24"x48" ±9 mm	Rectified Rettificato	146	•	•	•
	High Gloss LCP Lappato campo pieno	153	•	•	•
 <b>60x60</b> 24"x24" ±9 mm	Rectified Rettificato	140	•	•	•
 <b>FLOW</b> 60x120 24"x48" ±9 mm	Rectified Rettificato	151			•
 <b>BATTISCOPA</b> 6,5x120 2 1/2"x48"	Rectified Rettificato	120*	•	•	•

TOP SOLUTION available\_ [see related catalog](#)  • Price code / pc. Codice prezzo / pz.  
TOP SOLUTION disponibile\_ [consulta il catalogo](#)

### 3D Flow texture.

Struttura 3D Flow. Structure 3D Flow. 3D Flow Textur.



Amber  
FLOW  
60x120 24"x48"  
±9 mm  
RETT

### Mosaics.

Mosaici. Mosaïques. Mosaik.



All Colors  
MOSAICO ESAGONI  
26x30 10"x12"  
LCP  
-  
26x30 10"x12"  
NAT  
Price code / pc  
Codice prezzo / pz  
LCP 128  
NAT 122



General index

Product indexes

The Company

### Collections

Marble Look  
Concrete Look  
Stone Look  
Metal Look  
Wood Look  
Cotto Look



TH2.0  
Outdoor  
Solutions

Bathroom  
furniture

Ventilated  
facades

Technical  
information

# Verde Alpi

Nature bursts into space









WALL Verde Alpi 120x280 - 48" x110"

**R9**  
 Rectified  
 Rettificato  
 Rectifié  
 Rektifiziert  
**V3**

**High gloss LCP**  
 Lappato campo pieno  
 Semi-poli brillant  
 Hochglanz Lappato

**Porcelain stoneware coloured in body**  
 Gres porcellanato colorato in massa  
 Grès cérame coloré dans la masse  
 Eingefärbtes Feinsteinzeug



Size Formato	Finishes Finiture	Price code sqm Codice prezzo m²	
 <b>EKTREME</b> 120x280 48" x110" ±6 mm	High Gloss LCP Lappato campo pieno	167	•
 <b>60x120</b> 24" x48" ±9 mm	Rectified Rettificato	148	•
 <b>60x60</b> 24" x24" ±9 mm	High Gloss LCP Lappato campo pieno	150	•
 <b>BATTISCOPA</b> 6,5x120 2 1/8" x48"	High Gloss LCP Lappato campo pieno	127 *	 •
 <b>BATTISCOPA</b> 7,5x60 3" x24"	High Gloss LCP Lappato campo pieno	107 *	 •

\* Price code / pc. Codice prezzo / pz.

**Mosaics.**  
 Mosaici. Mosaïques. Mosaik.

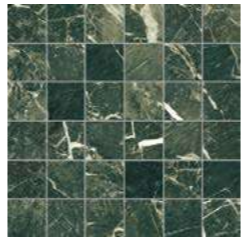

MOSAICO 36PZ  
 30x30 12" x12"  
 LCP  
 Price code / pc  
 Codice prezzo / pz  
**117**

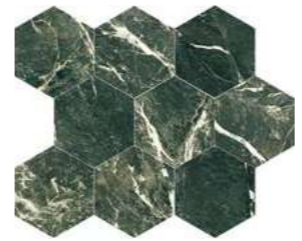

MOSAICO ESAGONI  
 26x30 10" x12"  
 LCP  
 Price code / pc  
 Codice prezzo / pz  
**128**



General index

Product indexes

The Company

**Collections**  
 Marble Look  
 Concrete Look  
 Stone Look  
 Metal Look  
 Wood Look  
 Cotto Look



TH2.0  
 Outdoor  
 Solutions

Bathroom  
 furniture

Ventilated  
 facades

Technical  
 information

# Treasures and Gems

Precious, elegant, unique



WALL **Emerald Paris** 120x280 . 48"x110"  
 FURNITURE **Bright Precious** 120x280 . 48"x110"  
 FLOOR **Bright Precious** 120x120 . 48"x48"

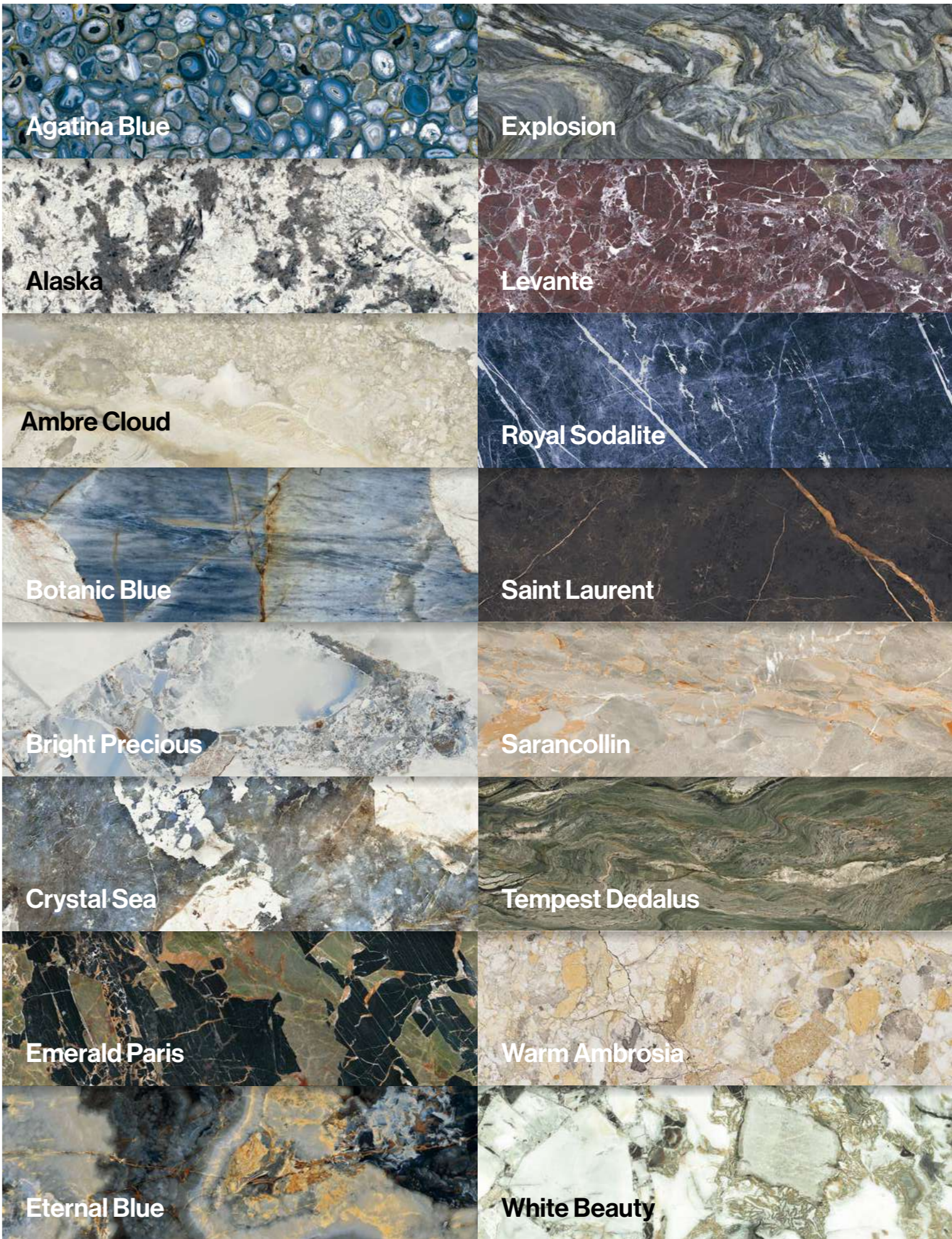

General index

Product indexes

The Company

**Collections**  
 Marble Look  
 Concrete Look  
 Stone Look  
 Metal Look  
 Wood Look  
 Cotto Look



TH2.0  
 Outdoor Solutions

Bathroom furniture

Ventilated facades

Technical information

# Agatina Blue

Mystic blue charm



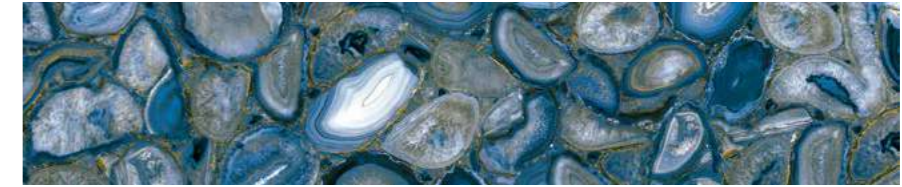

High gloss LCP  
Lappato campo pieno  
Semi-poli brillant  
Hochglanz Lappato

Porcelain stoneware  
Gres porcellanato  
Grès cérame coloré  
Feinsteinzeug



WALL Agatina Blue 120x280 . 48" x110"  
FLOOR Hollstone. Milky 120x120 . 48" x48"

Size Formato	Finishes Finiture	Price code sqm Codice prezzo m²
 <b>EKTREME</b> <b>120x280</b> 48" x110" → 6 mm	High Gloss LCP Lappato campo pieno	167
 <b>60x120</b> 24" x48" → 9 mm	High Gloss LCP Lappato campo pieno	155



Marble Look

Treasures and Gems

General index

Product indexes

The Company

## Collections

- Marble Look
- Concrete Look
- Stone Look
- Metal Look
- Wood Look
- Cotto Look



TH2.0  
Outdoor  
Solutions

Bathroom  
furniture

Ventilated  
facades

Technical  
information

# Alaska

Beauty impact



WALL **Alaska** 120x280 . 48"x110"  
 FURNITURE **Alaska** 163x324 . 64"x127" TOP SOLUTION  
 FLOOR **Massive.Snow** 120x120 . 48"x48"

**R9**  
 Rectificato  
 Rettificato  
 Rectifié  
 Rektifiziert

**V2**

**High gloss LCP**  
 Lappato campo pieno  
 Semi-poli brillant  
 Hochglanz Lappato

**Porcelain stoneware**  
 Gres porcellanato  
 Grès cérame coloré  
 Feinsteinzeug



Size Formato	Finishes Finiture	Price code sqm Codice prezzo m²
<p><b>EKTREME</b>  <b>120x280</b>                      48"x110"                      → 6 mm</p>	Rectified Rettificato	161
	High Gloss LCP Lappato campo pieno	167
<p><b>120x120</b>                      48"x48"                      → 9 mm</p>	Rectified Rettificato	155
	High Gloss LCP Lappato campo pieno	162
<p><b>60x120</b>                      24"x48"                      → 9 mm</p>	Rectified Rettificato	148
	High Gloss LCP Lappato campo pieno	155
<p><b>BATTISCOPA</b>  <b>6,5x120</b>                      2 1/4" x 48"</p>	Rectified Rettificato	120 *
	High Gloss LCP Lappato campo pieno	127 *

TOP SOLUTION available\_see related catalog • Price code / pc. Codice prezzo / pz.  
 TOP SOLUTION disponibile\_consulta il catalogo

## Mosaics.

Mosaici. Mosaiques. Mosaik.



MOSAICO ESAGONI  
 26x30 10"x12"  
 LCP

Price code / pc  
 Codice prezzo / pz  
**128**



General  
index

Product  
indexes

The  
Company

**Collections**  
 Marble Look  
 Concrete Look  
 Stone Look  
 Metal Look  
 Wood Look  
 Cotto Look



TH2.0  
Outdoor  
Solutions

Bathroom  
furniture

Ventilated  
facades

Technical  
information

# Ambre Cloud

Refined aesthetics



WALL Ambre Cloud 120x280 - 48"x110"  
FURNITURE Ambre Cloud 120x280 - 48"x110"

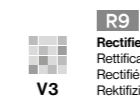





**R9**  
Rectificato  
Rettificato  
Rektifiziert

**High gloss LCP**  
Lappato campo pieno  
Semi-poli brillant  
Hochglanz Lappato

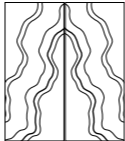
**Porcelain stoneware**  
Gres porcellanato  
Grès cérame coloré  
Feinsteinzeug



Size Formato	Finishes Finiture	Price code sqm Codice prezzo m²	
 <b>EKTREME</b> <b>120x280</b> 48"x110" → 6 mm	Rectified Rettificato	<b>161</b>	●
	High Gloss LCP Lappato campo pieno	<b>167</b>	●
 <b>EKTREME</b> <b>BOOKMATCH</b> <b>120x280</b> 48"x110" → 6 mm	High Gloss LCP Lappato campo pieno	<b>171</b>	●
 <b>60x120</b> 24"x48" → 9 mm	Rectified Rettificato	<b>148</b>	●
	High Gloss LCP Lappato campo pieno	<b>155</b>	●
 <b>BATTISCOPIA</b> <b>6,5x120</b> 2 1/4"x48"	High Gloss LCP Lappato campo pieno	<b>127*</b>	● 

\* Price code / pc. Codice prezzo / pz.

## Mosaics.

Mosaici. Mosaiques. Mosaik.



**MOSAICO ESAGONI**  
26x30 10"x12"  
LCP

Price code / pc  
Codice prezzo / pz  
**128**



## Bookmatch.

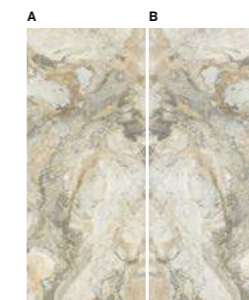

Composition 1



Composition 2



Composition 3



Composition 4

The image shown is for illustrative purposes only. As with natural marble slabs, Bookmatch patterns may present vein discontinuities between one slab and another. For this reason, differences of up to 1.5 cm are to be considered normal product characteristics. L'immagine rappresentata è a puro scopo illustrativo. Come per le lastre di marmo naturale, anche le grafiche Bookmatch possono presentare discontinuità tra una lastra e l'altra. Per questa ragione, differenze fino a 1.5 cm sono da considerarsi normali caratteristiche del prodotto.

General  
index

Product  
indexes

The  
Company

## Collections

Marble Look  
Concrete Look  
Stone Look  
Metal Look  
Wood Look  
Cotto Look



TH2.0  
Outdoor  
Solutions

Bathroom  
furniture

Ventilated  
facades

Technical  
information



# Botanic Blue

Nature secret



WALL Botanic Blue 120x280 . 48"x110"  
FLOOR Corsocomo, Coconut 120x120 . 48"x48"

**V4**  
High gloss LCP  
Lappato campo pieno  
Semi-poli brillant  
Hochglanz Lappato

**Porcelain stoneware**  
Gres porcellanato  
Grès cérame coloré  
Feinsteinzeug



Size Formato	Finishes Finiture	Price code sqm Codice prezzo m²
<b>EKXTREME</b> <b>120x280</b> 48"x110" → 6 mm	High Gloss LCP Lappato campo pieno	167
<b>EKXTREME</b> <b>BOOKMATCH</b> <b>120x280</b> 48"x110" → 6 mm	High Gloss LCP Lappato campo pieno	171

### Bookmatch.



The image shown is for illustrative purposes only. As with natural marble slabs, Bookmatch patterns may present vein discontinuities between one slab and another. For this reason, differences of up to 1.5 cm are to be considered normal product characteristics. L'immagine rappresentata è a puro scopo illustrativo. Come per le lastre di marmo naturale, anche le grafiche Bookmatch possono presentare discontinuità tra una lastra e l'altra. Per questa ragione, differenze fino a 1,5 cm sono da considerarsi normali caratteristiche del prodotto.

General index

Product indexes

The Company

**Collections**  
Marble Look  
Concrete Look  
Stone Look  
Metal Look  
Wood Look  
Cotto Look



TH2.0  
Outdoor Solutions

Bathroom furniture

Ventilated facades

Technical information

# Bright Precious

Rare beauty



WALL Bright Precious 120x280 . 48"x110"  
 FURNITURE Brera. Street 163x324 . 64"x127" TOP SOLUTION  
 FLOOR Brera. Street 120x120 . 48"x48"



WALL Bright Precious 120x280 . 48"x110"



# Bright Precious







**R9**  
 Rectified  
 Rettificato  
 Rectifié  
 Rektifiziert

**V3**

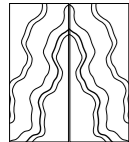
**High gloss LCP**  
 Lappato campo pieno  
 Semi-poli brillant  
 Hochglanz Lappato

**Porcelain stoneware**  
 Grès porcellanato  
 Grès cérame coloré  
 Feinsteinzeug



Size Formato	Finishes Finiture	Price code sqm Codice prezzo m²	
 <b>EKXTREME 120x280</b> 48"x110" → 6 mm	Rectified Rettificato	161	●
	High Gloss LCP Lappato campo pieno	167	●
 <b>EKXTREME BOOKMATCH 120x280</b> 48"x110" → 6 mm	High Gloss LCP Lappato campo pieno	171	●
 <b>120x120</b> 48"x48" → 9 mm	Rectified Rettificato	155	●
	High Gloss LCP Lappato campo pieno	162	●
 <b>60x120</b> 24"x48" → 9 mm	Rectified Rettificato	148	●
	High Gloss LCP Lappato campo pieno	155	●
 <b>FLOW 60x120</b> 24"x48" → 9 mm	Rectified Rettificato	151	●
 <b>BATTISCOPA 6,5x120</b> 2 1/4"x48"	Rectified Rettificato	120 *	● 
	High Gloss LCP Lappato campo pieno	127 *	● 

\* Price code / pc. Codice prezzo / pz.



WALL Bright Precious 120x280 . 48"x110"

## 3D Flow texture.

Struttura 3D Flow. Structure 3D Flow. 3D Flow Textur.

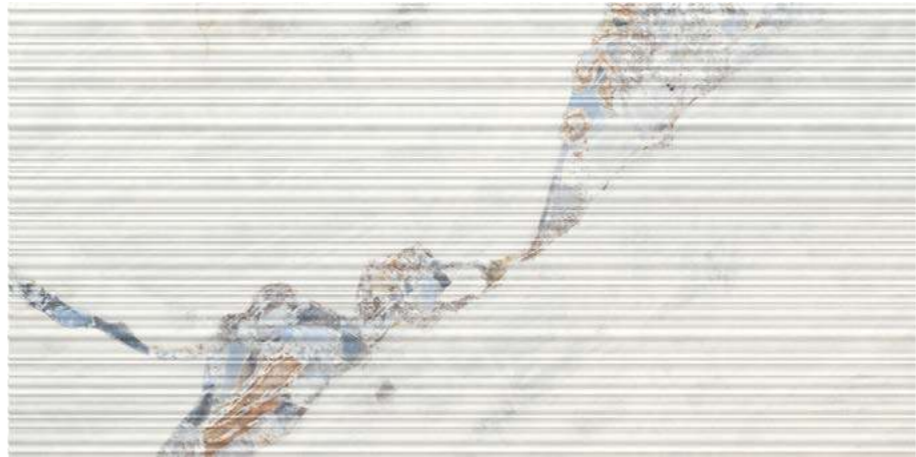

FLOW  
 60x120 24"x48"  
 → 9 mm  
 RETT

## Mosaics.

Mosaici. Mosaiques. Mosaik.



MOSAICO ESAGONI  
 26x30 10"x12"  
 LCP  
 Price code / pc  
 Codice prezzo / pz  
 128



## Bookmatch.



Composition 1



Composition 2



Composition 3



Composition 4

The image shown is for illustrative purposes only. As with natural marble slabs, Bookmatch patterns may present vein discontinuities between one slab and another. For this reason, differences of up to 1.5 cm are to be considered normal product characteristics. L'immagine rappresentata è a puro scopo illustrativo. Come per le lastre di marmo naturale, anche le grafiche Bookmatch possono presentare discontinuità tra una lastra e l'altra. Per questa ragione, differenze fino a 1,5 cm sono da considerarsi normali caratteristiche del prodotto.



# Crystal Sea

The power of colour







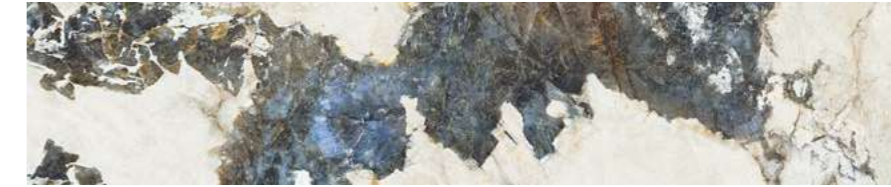

WALL **Crystal Sea** 120x280 . 48"x110" | **Res-Terrae. Tide** 60x120 . 24"x48"  
FLOOR **Res-Terrae. Cotton** 120x120 . 48"x48"

**R9**  
Rectificato  
Rettificato  
Rektifiziert  
**V4**

**High gloss LCP**  
Lappato campo pieno  
Semi-poli brillant  
Hochglanz Lappato

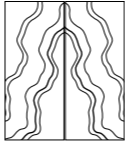
**Porcelain stoneware**  
Gres porcellanato  
Grès cérame coloré  
Feinsteinzeug

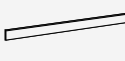

Size Formato	Finishes Finiture	Price code sqm Codice prezzo m²	
 <b>EKXTREME</b> <b>120x280</b> 48"x110" → 6 mm	Rectified Rettificato	<b>161</b>	●
	High Gloss LCP Lappato campo pieno	<b>167</b>	●
 <b>EKXTREME</b> <b>BOOKMATCH</b> <b>120x280</b> 48"x110" → 6 mm	High Gloss LCP Lappato campo pieno	<b>171</b>	●
 <b>120x120</b> 48"x48" → 9 mm	Rectified Rettificato	<b>155</b>	●
	High Gloss LCP Lappato campo pieno	<b>162</b>	●
 <b>60x120</b> 24"x48" → 9 mm	Rectified Rettificato	<b>148</b>	●
	High Gloss LCP Lappato campo pieno	<b>155</b>	●
 <b>BATTISCOPIA</b> <b>6,5x120</b> 2 1/8"x48"	High Gloss LCP Lappato campo pieno	<b>127*</b> 	●

\* Price code / pc. Codice prezzo / pz.

## Mosaics.

Mosaici. Mosaiques. Mosaik.



**MOSAICO ESAGONI**  
26x30 10"x12"  
LCP

Price code / pc  
Codice prezzo / pz  
**128**



## Bookmatch.



Composition 1



Composition 2



Composition 3



Composition 4

The image shown is for illustrative purposes only. As with natural marble slabs, Bookmatch patterns may present vein discontinuities between one slab and another. For this reason, differences of up to 1.5 cm are to be considered normal product characteristics. L'immagine rappresentata è a puro scopo illustrativo. Come per le lastre di marmo naturale, anche le grafiche Bookmatch possono presentare discontinuità tra una lastra e l'altra. Per questa ragione, differenze fino a 1,5 cm sono da considerarsi normali caratteristiche del prodotto.



# Emerald Paris



Precious look

**V4**  
High gloss LCP  
Lappato campo pieno  
Semi-poli brillant  
Hochglanz Lappato

**Porcelain stoneware**  
Gres porcellanato  
Grès cérame coloré  
Feinsteinzeug

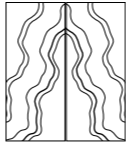

WALL **Emerald Paris** 120x280 . 48"x110"  
FURNITURE **Bright Precious** 120x280 . 48"x110"  
FLOOR **Bright Precious** 120x120 . 48"x48"

Size Formato	Finishes Finiture	Price code sqm Codice prezzo m <sup>2</sup>
 <b>EKXTREME</b> <b>120x280</b> 48"x110" → 6 mm	<b>High Gloss LCP</b> Lappato campo pieno	<b>167</b>
 <b>EKXTREME</b> <b>BOOKMATCH</b> <b>120x280</b> 48"x110" → 6 mm	<b>High Gloss LCP</b> Lappato campo pieno	<b>171</b>
 <b>60x120</b> 24"x48" → 9 mm	<b>High Gloss LCP</b> Lappato campo pieno	<b>155</b>

## Bookmatch.

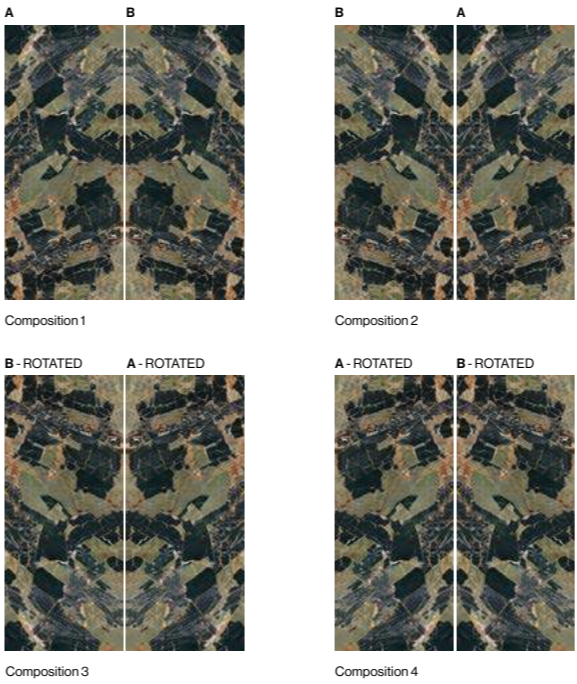

The image shown is for illustrative purposes only. As with natural marble slabs, Bookmatch patterns may present vein discontinuities between one slab and another. For this reason, differences of up to 1.5 cm are to be considered normal product characteristics. L'immagine rappresentata è a puro scopo illustrativo. Come per le lastre di marmo naturale, anche le grafiche Bookmatch possono presentare discontinuità tra una lastra e l'altra. Per questa ragione, differenze fino a 1,5 cm sono da considerarsi normali caratteristiche del prodotto.

General index

Product indexes

The Company

**Collections**  
Marble Look  
Concrete Look  
Stone Look  
Metal Look  
Wood Look  
Cotto Look

TH2.0  
Outdoor Solutions

Bathroom furniture

Ventilated facades

Technical information

# Eternal Blue

Golden waves



WALL **Eternal Blue** 120x280 . 48"x110"  
 BATHROOM FURNITURE **Eternal Blue** ☑  
 FLOOR **Eternal Blue** 120x280 . 48"x110"

**V4**  
 High gloss LCP  
 Lappato campo pieno  
 Semi-poli brillant  
 Hochglanz Lappato

**Porcelain stoneware coloured in body**  
 Gres porcellanato colorato in massa  
 Grès cérame coloré dans la masse  
 Eingefärbtes Feinsteinzeug



Size Formato	Finishes Finiture	Price code sqm Codice prezzo m²	
<b>EKXTREME</b> <b>120x280</b> 48"x110" → 6 mm	High Gloss LCP Lappato campo pieno	167	•
<b>EKXTREME</b> <b>BOOKMATCH</b> <b>120x280</b> 48"x110" → 6 mm	High Gloss LCP Lappato campo pieno	171	•
<b>60x120</b> 24"x48" → 9 mm	High Gloss LCP Lappato campo pieno	155	•
<b>BATTISCOPA</b> <b>6,5x120</b> 2 7/16" x 48"	High Gloss LCP Lappato campo pieno	127 *	•

\* Price code / pc. Codice prezzo / pz.

## Mosaics.

Mosaici. Mosaiques. Mosaik.

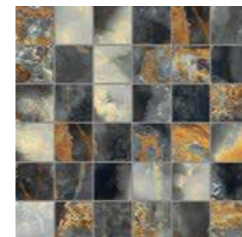

**MOSAICO 36PZ**  
**30x30 12"x12"**  
**LCP**

Price code / pc  
 Codice prezzo / pz  
**117**

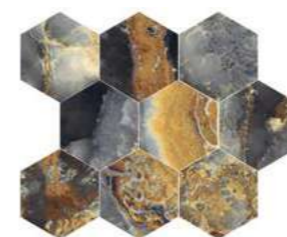

**MOSAICO ESAGONI**  
**26x30 10"x12"**  
**LCP**

Price code / pc  
 Codice prezzo / pz  
**128**



## Bookmatch.

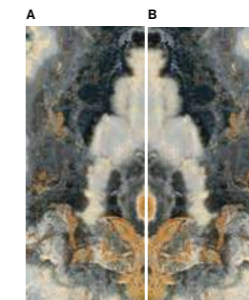

Composition 1



Composition 3



Composition 2

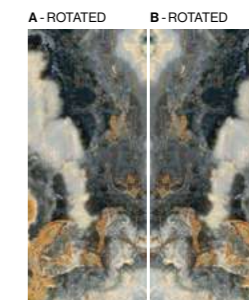

Composition 4

The image shown is for illustrative purposes only. As with natural marble slabs, Bookmatch patterns may present vein discontinuities between one slab and another. For this reason, differences of up to 1.5 cm are to be considered normal product characteristics. L'immagine rappresentata è a puro scopo illustrativo. Come per le lastre di marmo naturale, anche le grafiche Bookmatch possono presentare discontinuità tra una lastra e l'altra. Per questa ragione, differenze fino a 1.5 cm sono da considerarsi normali caratteristiche del prodotto.

General  
index

Product  
indexes

The  
Company

## Collections

Marble Look  
 Concrete Look  
 Stone Look  
 Metal Look  
 Wood Look  
 Cotto Look



TH2.0  
 Outdoor  
 Solutions

Bathroom  
 furniture

Ventilated  
 facades

Technical  
 information

# Explosion

Strong personality



WALL **Explosion** 120x280 . 48"x110"  
 FURNITURE **Explosion** 120x280 . 48"x110"  
 FLOOR **Genesis. Cocoa** 60x120 . 24"x48"

**R9**  
 Rectified  
 Rettificato  
 Rectifié  
 Rektifiziert

**V2**

**High gloss LCP**  
 Lappato campo pieno  
 Semi-poli brillant  
 Hochglanz Lappato

**Porcelain stoneware**  
 Gres porcellanato  
 Grès cérame coloré  
 Feinsteinzeug



Size Formato	Finishes Finiture	Price code sqm Codice prezzo m²
 <b>EKXTREME</b> <b>120x280</b> 48"x110" → 6 mm	Rectified Rettificato	161
	High Gloss LCP Lappato campo pieno	167

TOP SOLUTION available\_see related catalog

TOP SOLUTION disponibile\_consulta il catalogo



WALL **Explosion** 120x280 . 48"x110"  
 FURNITURE **Explosion** 120x280 . 48"x110"

General index

Product indexes

The Company

**Collections**

- Marble Look
- Concrete Look
- Stone Look
- Metal Look
- Wood Look
- Cotto Look



TH2.0  
 Outdoor  
 Solutions

Bathroom  
 furniture

Ventilated  
 facades

Technical  
 information

# Levante

Sparkling elegance



High gloss LCP  
Lappato campo pieno  
Semi-poli brillant  
Hochglanz Lappato

Porcelain stoneware  
Gres porcellanato  
Grès cérame coloré  
Feinsteinzeug

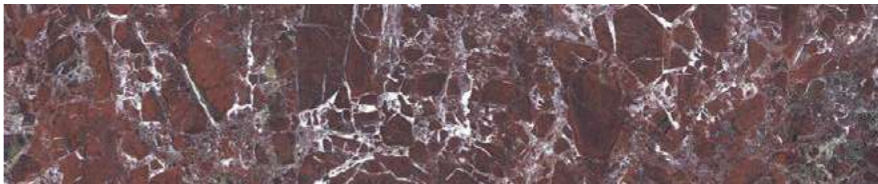

WALL Levante 120x280 . 48"x110"  
FURNITURE Taj Mahal Amber 120x280 . 48"x110"  
FLOOR Taj Mahal Amber 120x120 . 48"x48"

Size Formato	Finishes Finiture	Price code sqm Codice prezzo m²
 <b>EKTREME</b> <b>120x280</b> 48"x110" → 6 mm	High Gloss LCP Lappato campo pieno	167
 <b>60x120</b> 24"x48" → 9 mm	High Gloss LCP Lappato campo pieno	155

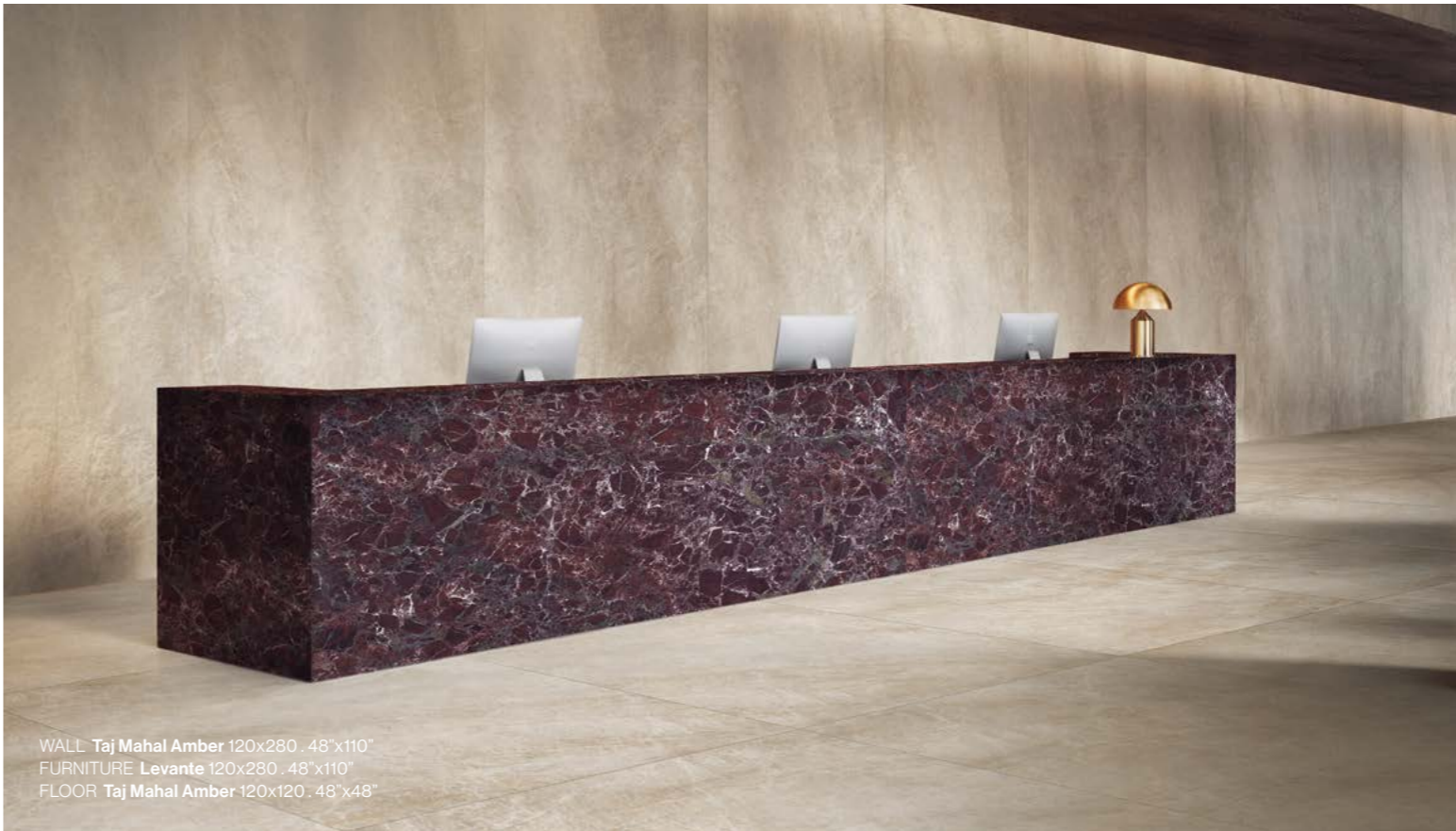

WALL Taj Mahal Amber 120x280 . 48"x110"  
FURNITURE Levante 120x280 . 48"x110"  
FLOOR Taj Mahal Amber 120x120 . 48"x48"

General index

Product indexes

The Company

Collections

- Marble Look
- Concrete Look
- Stone Look
- Metal Look
- Wood Look
- Cotto Look



TH2.0  
Outdoor  
Solutions

Bathroom  
furniture

Ventilated  
facades

Technical  
information



# Royal Sodalite

Intense blue luxury



WALL Royal Sodalite 120x280 . 48"x110" | 60x120 . 24"x48"  
 FLOOR Robur. Cocoa 30x160 . 12"x63"

**V2**  
 High gloss LCP  
 Lappato campo pieno  
 Semi-poli brillant  
 Hochglanz Lappato

**Porcelain stoneware**  
 Gres porcellanato  
 Grès cérame coloré  
 Feinsteinzeug



Size Formato	Finishes Finiture	Price code sqm Codice prezzo m <sup>2</sup>	
 <b>EKTREME</b> 120x280 48"x110" → 6 mm	High Gloss LCP Lappato campo pieno	167	•
 <b>60x120</b> 24"x48" → 9 mm	High Gloss LCP Lappato campo pieno	155	•
 <b>BATTISCOPIA</b> 6,5x120 2 1/8"x48"	High Gloss LCP Lappato campo pieno	127 *	• 

\* Price code / pc. Codice prezzo / pz.

## Mosaics.

Mosaici. Mosaiques. Mosaik.

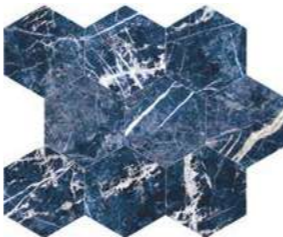

MOSAICO ESAGONI  
 26x30 10"x12"  
 LCP  
 Price code / pc  
 Codice prezzo / pz  
 128



General index

Product indexes

The Company

**Collections**  
 Marble Look  
 Concrete Look  
 Stone Look  
 Metal Look  
 Wood Look  
 Cotto Look



TH2.0  
 Outdoor Solutions

Bathroom furniture

Ventilated facades

Technical information

# Saint Laurent

When prestige is an attitude

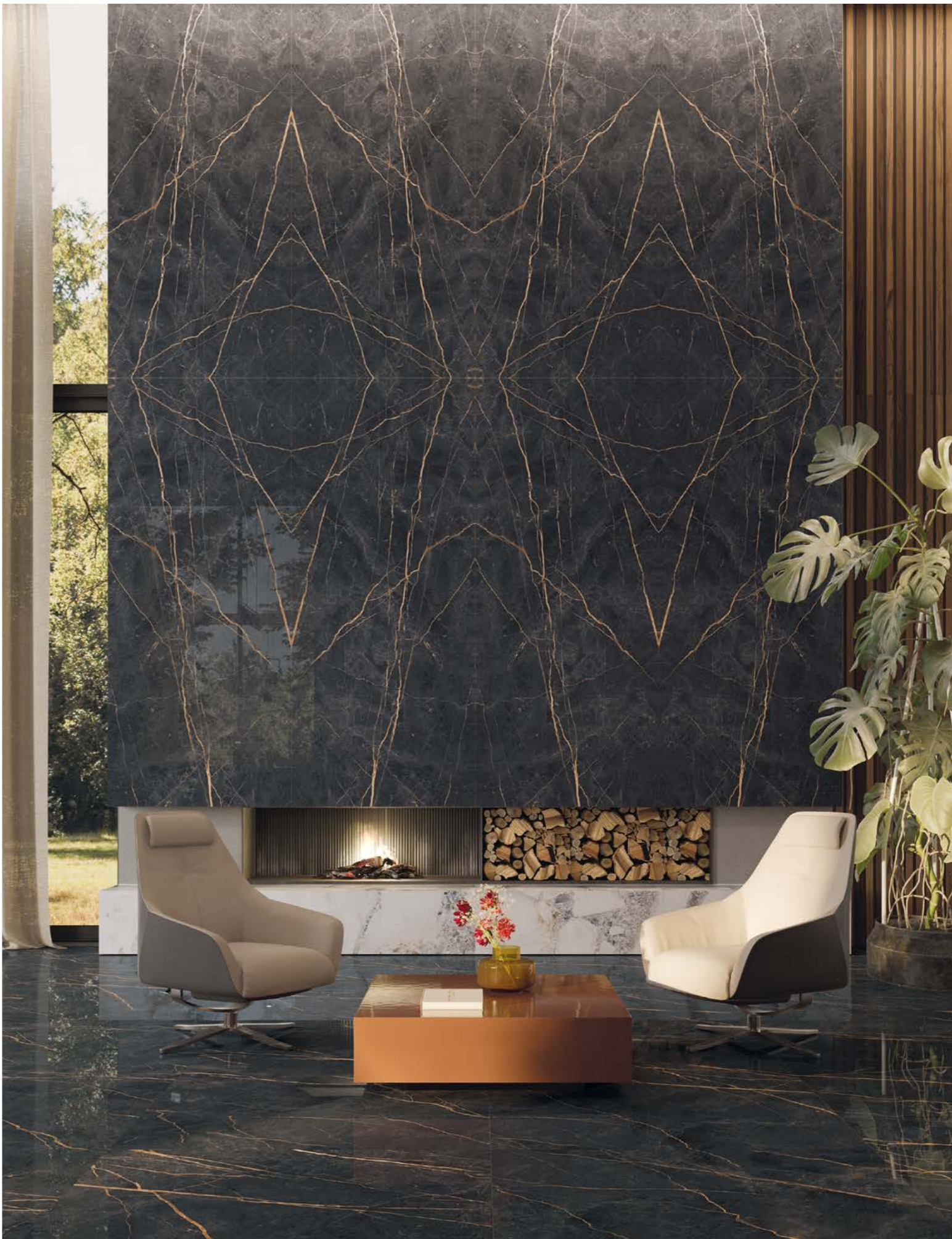

General index

Product indexes

The Company

### Collections

- Marble Look
- Concrete Look
- Stone Look
- Metal Look
- Wood Look
- Cotto Look



TH2.0  
Outdoor Solutions







Bathroom furniture

Ventilated facades

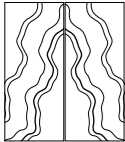
Technical information

# Saint Laurent

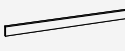

Size Formato	Finishes Finiture	Price code sqm Codice prezzo m <sup>2</sup>	
 <b>EKTREME</b> <b>120x280</b> 48"x110" → 6 mm	Rectified Rettificato	<b>161</b>	●
	High Gloss LCP Lappato campo pieno	<b>167</b>	●
 <b>EKTREME</b> <b>BOOKMATCH</b> <b>120x280</b> 48"x110" → 6 mm	High Gloss LCP Lappato campo pieno	<b>171</b>	●
 <b>120x120</b> 48"x48" → 9 mm	Rectified Rettificato	<b>155</b>	●
	High Gloss LCP Lappato campo pieno	<b>162</b>	●
 <b>60x120</b> 24"x48" → 9 mm	Rectified Rettificato	<b>148</b>	●
	High Gloss LCP Lappato campo pieno	<b>155</b>	●
 <b>60x60</b> 24"x24" → 9 mm	Rectified Rettificato	<b>141</b>	●
	High Gloss LCP Lappato campo pieno	<b>150</b>	●
 <b>30x60</b> 12"x24" → 9 mm	Rectified Rettificato	<b>139</b>	●
	High Gloss LCP Lappato campo pieno	<b>150</b>	●
 <b>BATTISCOPA</b> <b>6,5x120</b> 2 <sup>9</sup> / <sub>16</sub> "x48"	Rectified Rettificato	<b>120 *</b> 	●
	High Gloss LCP Lappato campo pieno	<b>127 *</b> 	●

TOP SOLUTION available, see related catalog [↗](#) • Price code / pc. Codice prezzo / pz.  
 TOP SOLUTION disponibile, consulta il catalogo [↗](#)

**R9**  
 Rectified  
 Rettificato  
 Rectifié  
 Rektifiziert

**V2**

**High gloss LCP**  
 Lappato campo pieno  
 Semi-poli brillant  
 Hochglanz Lappato

**Porcelain stoneware**  
 Gres porcellanato  
 Grès cérame coloré  
 Feinsteinzeug

General index

Product indexes

The Company

**Collections**

- Marble Look
- Concrete Look
- Stone Look
- Metal Look
- Wood Look
- Cotto Look

TH2.0  
 Outdoor Solutions

Bathroom furniture

Ventilated facades

Technical information

## Mosaics.

Mosaici. Mosaiques. Mosaik.



**MOSAICO ESAGONI**  
**26x30 10"x12"**  
**LCP**  
 Price code / pc.  
 Codice prezzo / pz.  
**128**



## Bookmatch.



The image shown is for illustrative purposes only. As with natural marble slabs, Bookmatch patterns may present vein discontinuities between one slab and another. For this reason, differences of up to 1.5 cm are to be considered normal product characteristics. L'immagine rappresentata è a puro scopo illustrativo. Come per le lastre di marmo naturale, anche le grafiche Bookmatch possono presentare discontinuità tra una lastra e l'altra. Per questa ragione, differenze fino a 1.5 cm sono da considerarsi normali caratteristiche del prodotto.

# Sarancollin

Radiant and warm depth



WALL Sarancollin 120x280 . 48"x110"

**R9**  
 Rectified  
 Rettificato  
 Rectifié  
 Rektifiziert

**High gloss LCP**  
 Lappato campo pieno  
 Semi-poli brillant  
 Hochglanz Lappato

**Porcelain stoneware**  
 Gres porcellanato  
 Grès cérame coloré  
 Feinsteinzeug



Size Formato	Finishes Finiture	Price code sqm Codice prezzo m²	
 <b>EKTREME</b> <b>120x280</b> 48"x110" → 6 mm	Rectified Rettificato	<b>161</b>	•
	High Gloss LCP Lappato campo pieno	<b>167</b>	•
 <b>120x120</b> 48"x48" → 9 mm	Rectified Rettificato	<b>155</b>	•
	High Gloss LCP Lappato campo pieno	<b>162</b>	•
 <b>60x120</b> 24"x48" → 9 mm	Rectified Rettificato	<b>148</b>	•
	High Gloss LCP Lappato campo pieno	<b>155</b>	•
 <b>60x60</b> 24"x24" → 9 mm	Rectified Rettificato	<b>141</b>	•
	High Gloss LCP Lappato campo pieno	<b>150</b>	•
 <b>BATTISCOPIA</b> <b>6,5x120</b> 2 1/8" x 48"	Rectified Rettificato	<b>120 *</b>	•
	High Gloss LCP Lappato campo pieno	<b>127 *</b>	•
 <b>BATTISCOPIA</b> <b>7,5x60</b> 3" x 24"	Rectified Rettificato	<b>106 *</b>	•
	High Gloss LCP Lappato campo pieno	<b>107 *</b>	•

\* Price code / pc. Codice prezzo / pz.

**Mosaics.**  
 Mosaici. Mosaïques. Mosaik.



**MOSAICO ESAGONI**  
 26x30 10"x12"  
 LCP  
 Price code / pc  
 Codice prezzo / pz  
**128**

General index

Product indexes

The Company

**Collections**  
 Marble Look  
 Concrete Look  
 Stone Look  
 Metal Look  
 Wood Look  
 Cotto Look



TH2.0  
 Outdoor  
 Solutions

Bathroom  
 furniture

Ventilated  
 facades

Technical  
 information

# Tempest Dedalus

Unconventional charm



WALL Tempest Dedalus 163x324 . 64"x127" TOP SOLUTION

**R9**  
 Rectified  
 Rettificato  
 Rectifié  
 Rektifiziert

**V2**

**High gloss LCP**  
 Lappato campo pieno  
 Semi-poli brillant  
 Hochglanz Lappato

**Porcelain stoneware**  
 Gres porcellanato  
 Grès cérame coloré  
 Feinsteinzeug



Size Formato	Finishes Finiture	Price code sqm Codice prezzo m²
 <b>EKXTREME</b> <b>120x280</b> 48"x110" → 6 mm	Rectified Rettificato	161
	High Gloss LCP Lappato campo pieno	167

TOP SOLUTION available\_see related catalog

TOP SOLUTION disponibile\_consulta il catalogo



WALL Tempest Dedalus 120x280 . 48"x110"

General index

Product indexes

The Company

**Collections**

- Marble Look
- Concrete Look
- Stone Look
- Metal Look
- Wood Look
- Cotto Look



TH2.0  
 Outdoor  
 Solutions

Bathroom  
 furniture

Ventilated  
 facades

Technical  
 information

# Warm Ambrosia

Intriguing color patterns



WALL Warm Ambrosia 120x280 - 48"x110"



**R9**  
Rectificato  
Rettificato  
Rektifiziert

**High gloss LCP**  
Lappato campo pieno  
Semi-poli brillant  
Hochglanz Lappato

**Porcelain stoneware**  
Gres porcellanato  
Grès cérame coloré  
Feinsteinzeug



Size Formato	Finishes Finiture	Price code sqm Codice prezzo m²	
 <b>EKTREME</b> <b>120x280</b> 48"x110" → 6 mm	Rectified Rettificato	161	•
	High Gloss LCP Lappato campo pieno	167	•
 <b>120x120</b> 48"x48" → 9 mm	Rectified Rettificato	155	•
	High Gloss LCP Lappato campo pieno	162	•
 <b>60x120</b> 24"x48" → 9 mm	Rectified Rettificato	148	•
	High Gloss LCP Lappato campo pieno	155	•
 <b>BATTISCOPA</b> <b>6,5x120</b> 2 1/4"x48"	Rectified Rettificato	120 *	
	High Gloss LCP Lappato campo pieno	127 *	

\* Price code / pc. Codice prezzo / pz.

## Mosaics.

Mosaici. Mosaiques. Mosaik.

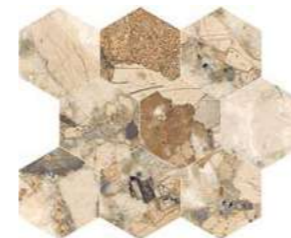

MOSAICO ESAGONI  
26x30 10"x12"  
LCP

Price code / pc  
Codice prezzo / pz  
128



# White Beauty

Like a gem



WALL White Beauty 120x280 . 48"x110"  
 FURNITURE White Beauty 163x324 . 64"x127" TOP SOLUTION  
 FLOOR Padouk. Nut 20x160 . 8"x63"



R9  
 Rectified  
 Rettificato  
 Rectifié  
 Rektifiziert

High gloss LCP  
 Lappato campo pieno  
 Semi-poli brillant  
 Hochglanz Lappato

Porcelain stoneware  
 Gres porcellanato  
 Grès cérame coloré  
 Feinsteinzeug



Size Formato	Finishes Finiture	Price code sqm Codice prezzo m <sup>2</sup>	
 <b>EKTREME</b> <b>120x280</b> 48"x110" → 6 mm	Rectified Rettificato	161	●
	High Gloss LCP Lappato campo pieno	167	●
 <b>EKTREME</b> <b>BOOKMATCH</b> <b>120x280</b> 48"x110" → 6 mm	High Gloss LCP Lappato campo pieno	171	●
 <b>120x120</b> 48"x48" → 9 mm	Rectified Rettificato	155	●
	High Gloss LCP Lappato campo pieno	162	●
 <b>60x120</b> 24"x48" → 9 mm	Rectified Rettificato	148	●
	High Gloss LCP Lappato campo pieno	155	●
 <b>BATTISCOPIA</b> <b>6,5x120</b> 2 1/8"x48"	Rectified Rettificato	120 *	●
	High Gloss LCP Lappato campo pieno	127 *	●

TOP SOLUTION available\_ see related catalog | TOP SOLUTION disponibile\_ consulta il catalogo

\* Price code / pc. Codice prezzo / pz.

## Mosaics.

Mosaici. Mosaiques. Mosaik.



MOSAICO ESAGONI  
 26x30 10"x12"  
 LCP

Price code / pc.  
 Codice prezzo / pz  
 128



## Bookmatch.



Composition 1



Composition 2



Composition 3

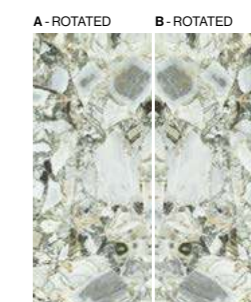

Composition 4

The image shown is for illustrative purposes only. As with natural marble slabs, Bookmatch patterns may present vein discontinuities between one slab and another. For this reason, differences of up to 1.5 cm are to be considered normal product characteristics. L'immagine rappresentata è a puro scopo illustrativo. Come per le lastre di marmo naturale, anche le grafiche Bookmatch possono presentare discontinuità tra una lastra e l'altra. Per questa ragione, differenze fino a 1,5 cm sono da considerarsi normali caratteristiche del prodotto.

General  
index

Product  
indexes

The  
Company

## Collections

Marble Look  
 Concrete Look  
 Stone Look  
 Metal Look  
 Wood Look  
 Cotto Look



TH2.0  
 Outdoor  
 Solutions

Bathroom  
 furniture

Ventilated  
 facades

Technical  
 information

# Index A - Z

Indice A - Z. Index A - Z. Alphabetisches Verzeichnis.

**Brera**  
**Cementine**  
**City Plaster**  
**Concept**  
**Corsocomo**  
**H24**  
**Loft**  
**Massive**  
**Mood**  
**Parker**  
**Res-Terrae**  
**Select**  
**Unicolors**  
**Wallart**

# Concrete Look

**General  
index**

**Product  
indexes**

**The  
Company**

## **Collections**

Marble Look  
**Concrete Look**  
Stone Look  
Metal Look  
Wood Look  
Cotto Look



**TH2.0  
Outdoor  
Solutions**

**Bathroom  
furniture**

**Ventilated  
facades**

**Technical  
information**



# Brera

Milan style attitude



WALL Bloom 120x280 . 48"x110"  
 FLOOR Frame 120x120 . 48"x48"

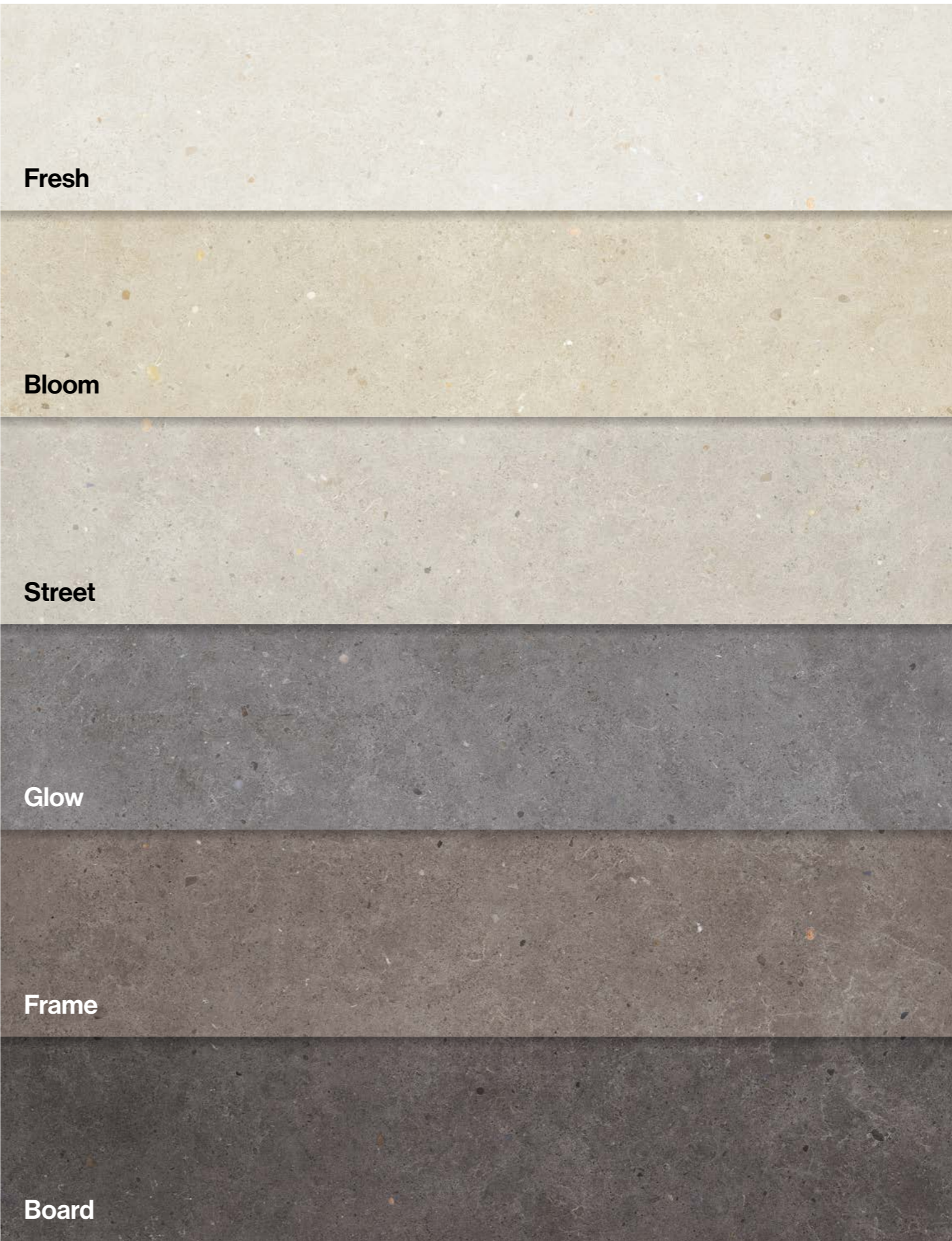

Fresh

Bloom

Street

Glow

Frame

Board

General index

Product indexes

The Company

### Collections

- Marble Look
- Concrete Look**
- Stone Look
- Metal Look
- Wood Look
- Cotto Look



TH2.0 Outdoor Solutions

Bathroom furniture

Ventilated facades

Technical information



Size Formato	Finishes Finiture	Price code sqm Codice prezzo m <sup>2</sup>	Fresh	Bloom	Street	Glow	Frame	Board
EKTREME 120x280 48"x110" ±6 mm	Rectified Rettificato	159	•	•	•			
120x120 48"x48" ±9 mm	Rectified Rettificato	153	•	•	•	•	•	•
60x120 24"x48" ±9 mm	Rectified Rettificato	144	•	•	•	•	•	•
80x80 32"x32" ±9 mm	Rectified Rettificato	146	•	•	•	•	•	•
60x60 24"x24" ±9 mm	Rectified Rettificato	139	•	•	•	•	•	•
	Antislip Sabbiato	140	•	•	•	•	•	•
30x60 12"x24" ±9 mm	Rectified Rettificato	137	•	•	•	•	•	•
BATTISCOPA 6,5x120 2 1/8"x48"	Rectified Rettificato	120*	•	•	•	•	•	•
BATTISCOPA 7,5x80 3"x32"	Rectified Rettificato	109*	•	•	•	•	•	•
BATTISCOPA 7,5x60 3"x24"	Rectified Rettificato	106*	•	•	•	•	•	•

TOP SOLUTION available [see related catalog](#) TH2.0 OUTDOOR SOLUTIONS available   
TOP SOLUTION disponibile [consulta il catalogo](#) TH2.0 OUTDOOR SOLUTIONS disponibile

\* Price code / pc. Codice prezzo / pz.



WALL Board 60x120 24"x48"  
FLOOR Fresh 120x120 . 48"x48" | Glow 120x120 . 48"x48"



WALL Parker. Silver 120x280 . 48"x110"  
FLOOR Street 120x120 . 48"x48"

## Mosaics.

Mosaici. Mosaiques. Mosaik.



**Fresh**  
 MOSAICO 36PZ  
 30x30 12"x12"  
**NAT**

Price code / pc  
 Codice prezzo / pz  
**110**



**Fresh**  
 MOSAICO ESAGONI  
 26x30 10"x12"  
**NAT**

Price code / pc  
 Codice prezzo / pz  
**122**

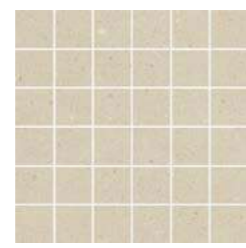

**Bloom**  
 MOSAICO 36PZ  
 30x30 12"x12"  
**NAT**

Price code / pc  
 Codice prezzo / pz  
**110**



**Bloom**  
 MOSAICO ESAGONI  
 26x30 10"x12"  
**NAT**

Price code / pc  
 Codice prezzo / pz  
**122**



**Street**  
 MOSAICO 36PZ  
 30x30 12"x12"  
**NAT**

Price code / pc  
 Codice prezzo / pz  
**110**



**Street**  
 MOSAICO ESAGONI  
 26x30 10"x12"  
**NAT**

Price code / pc  
 Codice prezzo / pz  
**122**

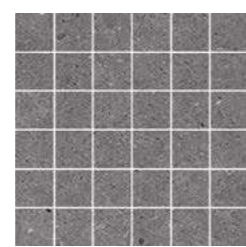

**Glow**  
 MOSAICO 36PZ  
 30x30 12"x12"  
**NAT**

Price code / pc  
 Codice prezzo / pz  
**110**



**Glow**  
 MOSAICO ESAGONI  
 26x30 10"x12"  
**NAT**

Price code / pc  
 Codice prezzo / pz  
**122**

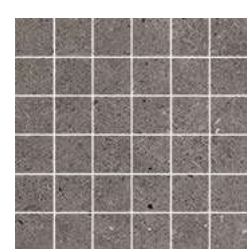

**Frame**  
 MOSAICO 36PZ  
 30x30 12"x12"  
**NAT**

Price code / pc  
 Codice prezzo / pz  
**110**



**Frame**  
 MOSAICO ESAGONI  
 26x30 10"x12"  
**NAT**

Price code / pc  
 Codice prezzo / pz  
**122**

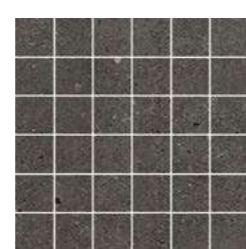

**Board**  
 MOSAICO 36PZ  
 30x30 12"x12"  
**NAT**

Price code / pc  
 Codice prezzo / pz  
**110**



**Board**  
 MOSAICO ESAGONI  
 26x30 10"x12"  
**NAT**

Price code / pc  
 Codice prezzo / pz  
**122**



WALL Bloom Mosaico Esagoni 26x30 . 10"x12"

Concrete Look Brera



# Cementine

Minimal elegance



FLOOR Nebbia 60x60 . 24"x24"

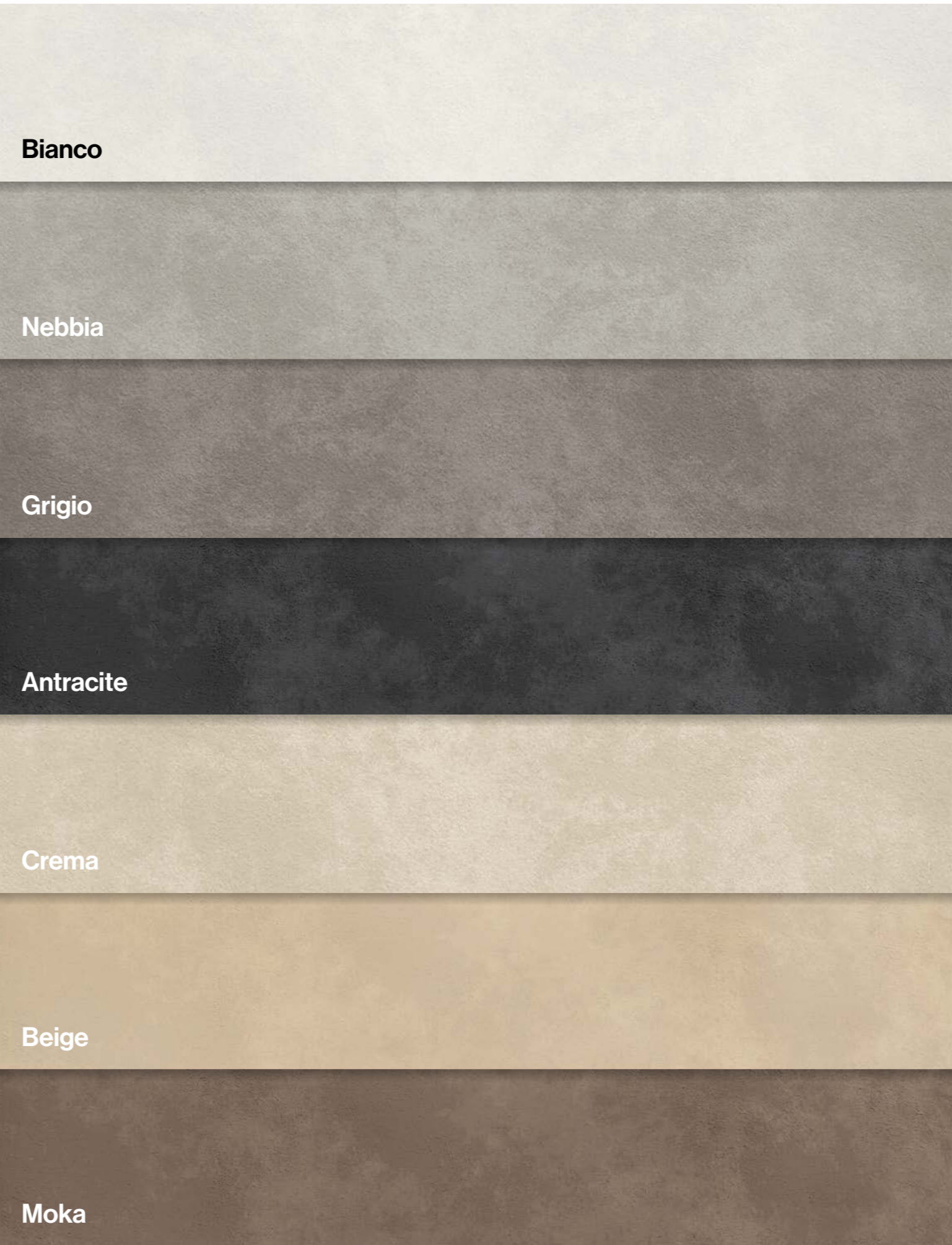

Bianco

Nebbia

Grigio

Antracite

Crema

Beige

Moka

General index

Product indexes

The Company

### Collections

- Marble Look
- Concrete Look**
- Stone Look
- Metal Look
- Wood Look
- Cotto Look



TH2.0  
Outdoor  
Solutions

Bathroom  
furniture

Ventilated  
facades

Technical  
information

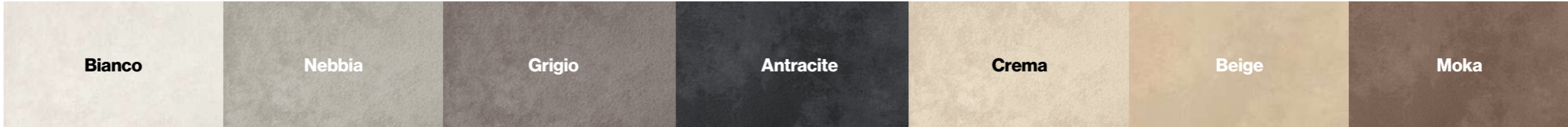

Size Formato	Finishes Finiture	Price code sqm Codice prezzo m <sup>2</sup>	Bianco	Nebbia	Grigio	Antracite	Crema	Beige	Moka
 <b>60x60</b> 24"x24" ±9 mm	Rectified Rettificato	139	•	•	•	•	•	•	•
	Antislip Sabbiato	140	•	•	•	•	•	•	•
 <b>30,8x61,5</b> 12"x24" ±9 mm	Natural Naturale	131	•	•	•	•	•	•	•
	Matt Opaco	125	•	•	•	•	•	•	•
 BICOTTURA <b>20x50</b> 8"x20" ±8 mm	Rectified Rettificato	106*	•	•	•	•	•	•	•
	BATTISCOPIA <b>7,5x60</b> 3"x24"	106*	•	•	•	•	•	•	•

\* Price code / pc. Codice prezzo / pz.



WALL Moka 30,8x61,5 . 12"x24" | Crema 20x50 . 8"x20" | Decoro Cementine Quadri Mix 20x50 . 8"x20"  
 FLOOR Beige 60x60 . 24"x24"

### Decors. Decori. Décor. Dekor.



Quadri Mix  
 DECORO CEMENTINE  
 20x50 8"x20"  
 ±8 mm  
 BICOTTURA  
 Price code / sqm  
 Codice prezzo / m<sup>2</sup>  
 130

Concrete Look Cementine

General index

Product indexes

The Company

### Collections

- Marble Look
- Concrete Look
- Stone Look
- Metal Look
- Wood Look
- Cotto Look



TH2.0  
 Outdoor  
 Solutions

Bathroom  
 furniture

Ventilated  
 facades

Technical  
 information

# City Plaster

Strong background



WALL Graffiti Multicolor 120x280 . 48"x110"  
FLOOR Grey 120x120 . 48"x48"



Concrete Look City Plaster

General index

Product indexes

The Company

## Collections

- Marble Look
- Concrete Look
- Stone Look
- Metal Look
- Wood Look
- Cotto Look



TH2.0  
Outdoor  
Solutions

Bathroom  
furniture

Ventilated  
facades

Technical  
information

# City Plaster



Size Formato	Finishes Finiture	Price code sqm Codice prezzo m <sup>2</sup>	•	•	•	•	
	<b>EKTREME 120x280</b> 48"x110" → 6 mm	<b>Rectified</b> Rettificato	159	•	•	•	•
	<b>High Gloss LCP</b> Lappato campo pieno	166	•	•	•	•	
	<b>120x120</b> 48"x48" → 9 mm	<b>Rectified</b> Rettificato	153	•	•	•	•
		<b>60x120</b> 24"x48" → 9 mm	<b>Rectified</b> Rettificato	144	•	•	•
<b>High Gloss LCP</b> Lappato campo pieno		153	•	•	•	•	
	<b>60x60</b> 24"x24" → 9 mm	<b>Rectified</b> Rettificato	139	•	•	•	•
		<b>30x60</b> 12"x24" → 9 mm	<b>Rectified</b> Rettificato	137	•	•	•
		<b>BATTISCOPIA 6,5x120</b> 2 1/8"x48"	<b>Rectified</b> Rettificato	120 *	•	•	•
	<b>High Gloss LCP</b> Lappato campo pieno	127 *	•	•	•	•	
	<b>BATTISCOPIA 7,5x60</b> 3"x24"	<b>Rectified</b> Rettificato	106 *	•	•	•	•

\* Price code / pc. Codice prezzo / pz.



Size Formato	Finishes Finiture	Price code sqm Codice prezzo m <sup>2</sup>	•	•	•	•	
	<b>EKTREME 120x280</b> 48"x110" → 6 mm	<b>Rectified</b> Rettificato	164	•	•	•	•
		<b>60x120</b> 24"x48" → 9 mm	<b>Rectified</b> Rettificato	160	•	•	•

\* 120x280: 6 subjects available. 6 soggetti disponibili.  
60x120: 36 subjects available. 36 soggetti disponibili.

**R10**  
Rectified  
Rettificato  
Rectifié  
Rektifiziert  
**V4**

**High gloss LCP**  
Lappato campo pieno  
Semi-poli brillant  
Hochglanz Lappato

**Porcelain stoneware coloured in body**  
Gres porcellanato colorato in massa  
Grès cérame coloré dans la masse  
Eingefärbtes Feinsteinzeug

## Mosaics.

Mosaici. Mosaïques. Mosaik.



White  
MOSAICO 36PZ  
30x30 12"x12"  
NAT

Price code / pc  
Codice prezzo / pz  
**110**



White  
MOSAICO ESAGONI  
26x30 10"x12"  
NAT

Price code / pc  
Codice prezzo / pz  
**122**



Grey  
MOSAICO 36PZ  
30x30 12"x12"  
NAT

Price code / pc  
Codice prezzo / pz  
**110**



Grey  
MOSAICO ESAGONI  
26x30 10"x12"  
NAT

Price code / pc  
Codice prezzo / pz  
**122**



Beige  
MOSAICO 36PZ  
30x30 12"x12"  
NAT

Price code / pc  
Codice prezzo / pz  
**110**



Beige  
MOSAICO ESAGONI  
26x30 10"x12"  
NAT

Price code / pc  
Codice prezzo / pz  
**122**

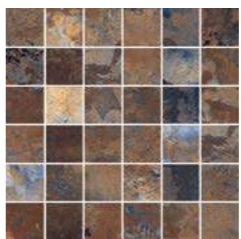

Multicolor  
MOSAICO 36PZ  
30x30 12"x12"  
NAT

Price code / pc  
Codice prezzo / pz  
**110**



Multicolor  
MOSAICO ESAGONI  
26x30 10"x12"  
NAT

Price code / pc  
Codice prezzo / pz  
**122**



General index

Product indexes

The Company

### Collections

- Marble Look
- Concrete Look
- Stone Look
- Metal Look
- Wood Look
- Cotto Look



TH2.0  
Outdoor  
Solutions

Bathroom  
furniture

Ventilated  
facades

Technical  
information

# City Plaster

**R10**  
 Rectified  
 Rettificato  
 Rectifié  
 Rektifiziert

**V4**

**High gloss LCP**  
 Lappato campo pieno  
 Semi-poli brillante  
 Hochglanz Lappato

**Porcelain stoneware coloured in body**  
 Gres porcellanato colorato in massa  
 Grès cérame coloré dans la masse  
 Eingefärbtes Feinsteinzeug

**Pattern variation.**  
 Sviluppo grafico. Développement graphique par format. Farbverlauf.



60x60 24"x24"



60x60 24"x24"



60x60 24"x24"

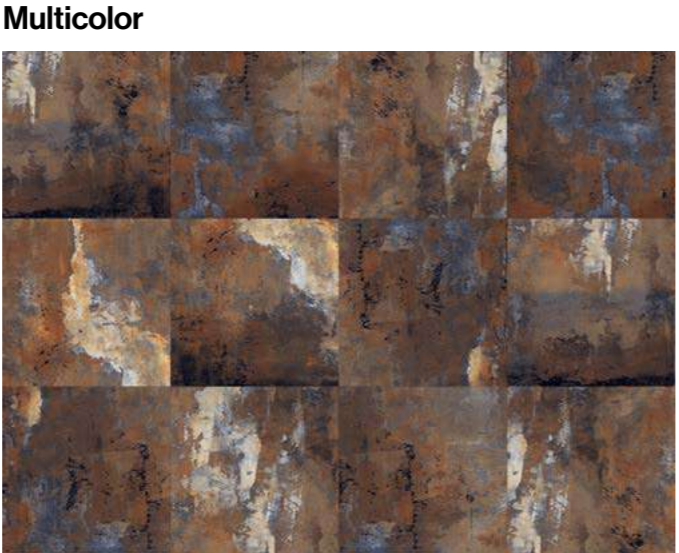

60x60 24"x24"



WALL **Beige** 120x280 . 48"x110"  
 FLOOR **Beige** 120x120 . 48"x48"

Concrete Look City Plaster

General index

Product indexes

The Company

- Collections**
- Marble Look
  - Concrete Look**
  - Stone Look
  - Metal Look
  - Wood Look
  - Cotto Look



TH2.0  
 Outdoor Solutions

Bathroom furniture

Ventilated facades

Technical information



# City Plaster

## Graffiti developments.

Graffiti sviluppi. Développements du Graffiti. Entwicklungen der Graffiti.



120x280 48"x110"

## 6

**Themes sorted by colour**  
Soggetti per colore  
Sujets par couleur  
Themen nach Farbe

**Available in all colours**  
Disponibile in tutti i colori  
Disponible dans toutes les couleurs  
Erhältlich in allen Farben



**Graffiti White**



**Graffiti Grey**



**Graffiti Beige**



**Graffiti Multicolor**



60x120 24"x48"

R10

Rectified  
Rettificato  
Rectifié  
Rektifiziert

V4

High gloss LCP  
Lappato campo pieno  
Semi-poli brillant  
Hochglanz Lappato

**Porcelain stoneware coloured in body**  
Gres porcellanato colorato in massa  
Grès cérame coloré dans la masse  
Eingefärbtes Feinsteinzeug

## 36

**Themes sorted by colour**  
Soggetti per colore  
Sujets par couleur  
Themen nach Farbe

**Available in all colours**  
Disponibile in tutti i colori  
Disponible dans toutes les couleurs  
Erhältlich in allen Farben



**Graffiti White**



**Graffiti Grey**



**Graffiti Beige**



**Graffiti Multicolor**



WALL Graffiti Grey 120x280 48"x110" | Grey 120x280 48"x110"  
FLOOR Grey 120x120 48"x48"

Concrete Look City Plaster

# Concept

Sober nuances



WALL Pearl 120x120 .48"x48"

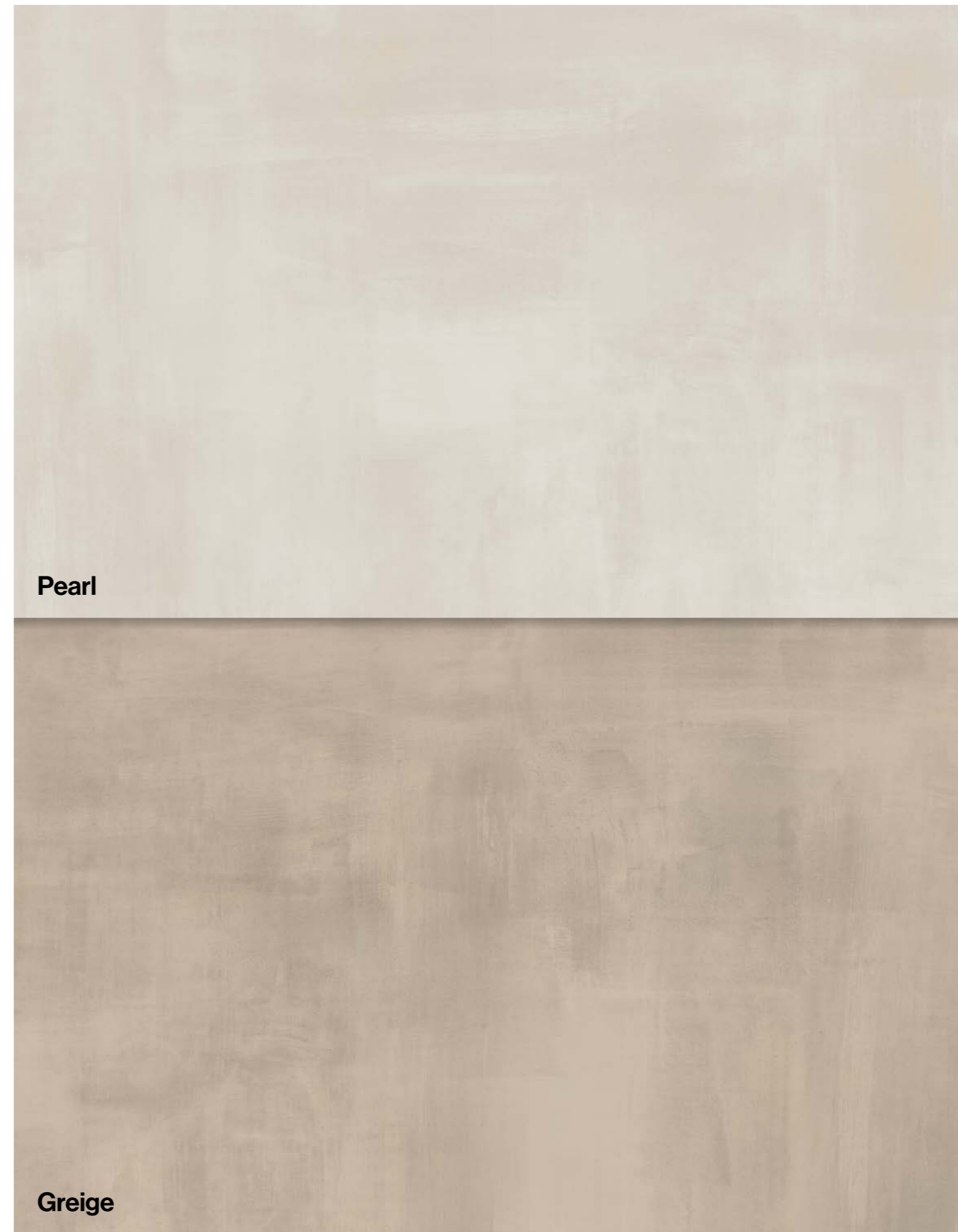

Pearl

Greige

General index

Product indexes

The Company

## Collections

- Marble Look
- Concrete Look**
- Stone Look
- Metal Look
- Wood Look
- Cotto Look



TH2.0  
Outdoor  
Solutions

Bathroom  
furniture

Ventilated  
facades

Technical  
information

# Concept



FLOOR Greige 80x80 . 32"x32"

V1  
**R9**  
 Rectificato  
 Rettificato  
 Rektifiziert

**R11**  
 Antislip  
 Sabbiato  
 Anti-dérapant  
 Gesandet

**Porcelain stoneware coloured in body**  
 Gres porcellanato colorato in massa  
 Grès cérame coloré dans la masse  
 Eingefärbtes Feinsteinzeug



Size Formato	Finishes Finiture	Price code sqm Codice prezzo m²	Pearl	Greige
<b>120x120</b> 48"x48" ⇒ 9 mm	Rectified Rettificato	153	•	•
<b>60x120</b> 24"x48" ⇒ 9 mm	Rectified Rettificato	144	•	•
<b>80x80</b> 32"x32" ⇒ 9 mm	Rectified Rettificato	146	•	•
<b>60x60</b> 24"x24" ⇒ 9 mm	Rectified Rettificato	139	•	•
<b>BATTISCOPA</b> <b>6,5x120</b> 2 7/16"x48"	Rectified Rettificato	120 *	•	•
<b>BATTISCOPA</b> <b>7,5x80</b> 3"x32"	Rectified Rettificato	109 *	•	•
<b>BATTISCOPA</b> <b>7,5x60</b> 3"x24"	Rectified Rettificato	106 *	•	•

\* Price code / pc. Codice prezzo / pz.

### Mosaics.

Mosaici. Mosaïques. Mosaik.

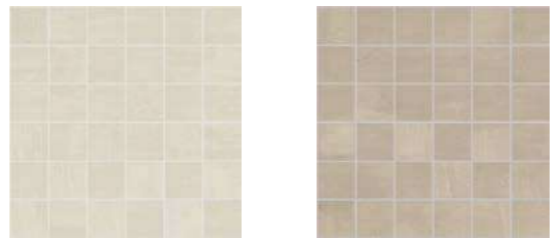

Pearl  
 MOSAICO 36PZ  
 30x30 12"x12"  
 NAT

Price code / pc  
 Codice prezzo / pz  
**110**



Greige  
 MOSAICO 36PZ  
 30x30 12"x12"  
 NAT

Price code / pc  
 Codice prezzo / pz  
**110**



General index

Product indexes

The Company

**Collections**  
 Marble Look  
 Concrete Look  
 Stone Look  
 Metal Look  
 Wood Look  
 Cotto Look

TH2.0  
 Outdoor  
 Solutions

Bathroom  
 furniture

Ventilated  
 facades

Technical  
 information

# Corsocomo

Stylish shades



WALL **Cookie** 120x120 . 48"x48"  
 FLOOR **Meringue** 120x120 . 48"x48"



Coconut

Meringue

Cookie

Drop

Storm

Midnight

General index

Product indexes

The Company

### Collections

- Marble Look
- Concrete Look**
- Stone Look
- Metal Look
- Wood Look
- Cotto Look



TH2.0  
Outdoor Solutions

Bathroom furniture

Ventilated facades

Technical information



Size Formato	Finishes Finiture	Price code sqm Codice prezzo m <sup>2</sup>	Coconut	Meringue	Cookie	Drop	Storm	Midnight
<b>120x120</b> 48"x48" ±9 mm	Rectified Rettificato	153	•	•	•	•	•	•
<b>60x120</b> 24"x48" ±9 mm	Rectified Rettificato	144	•	•	•	•	•	•
<b>80x80</b> 32"x32" ±9 mm	Rectified Rettificato	146	•	•	•	•	•	•
<b>60x60</b> 24"x24" ±9 mm	Rectified Rettificato	139	•	•	•	•	•	•
	Antislip Sabbiato	140	•	•	•	•	•	•
<b>30x60</b> 12"x24" ±9 mm	Rectified Rettificato	139	•	•	•	•	•	•
<b>BATTISCOPIA</b> <b>6,5x120</b> 2 1/8"x48"	Rectified Rettificato	120 *	•	•	•	•	•	•
<b>BATTISCOPIA</b> <b>7,5x80</b> 3"x32"	Rectified Rettificato	109 *	•	•	•	•	•	•
<b>BATTISCOPIA</b> <b>7,5x60</b> 3"x24"	Rectified Rettificato	106 *	•	•	•	•	•	•

\* Price code / pc. Codice prezzo / pz.



FLOOR Meringue 120x120 . 48"x48" | Cookie 120x120 . 48"x48"

**Mosaics.**  
 Mosaici. Mosaiques. Mosaik.



**Coconut**  
 MOSAICO 36PZ  
 30x30 12"x12"  
**NAT**  
 Price code / pc  
 Codice prezzo / pz  
**110**

**Meringue**  
 MOSAICO 36PZ  
 30x30 12"x12"  
**NAT**  
 Price code / pc  
 Codice prezzo / pz  
**110**

**Cookie**  
 MOSAICO 36PZ  
 30x30 12"x12"  
**NAT**  
 Price code / pc  
 Codice prezzo / pz  
**110**



**Drop**  
 MOSAICO 36PZ  
 30x30 12"x12"  
**NAT**  
 Price code / pc  
 Codice prezzo / pz  
**110**

**Storm**  
 MOSAICO 36PZ  
 30x30 12"x12"  
**NAT**  
 Price code / pc  
 Codice prezzo / pz  
**110**

**Midnight**  
 MOSAICO 36PZ  
 30x30 12"x12"  
**NAT**  
 Price code / pc  
 Codice prezzo / pz  
**110**



FLOOR Meringue 120x120 . 48"x48" | Cookie 120x120 . 48"x48"

Concrete Look Corsocomo

General index

Product indexes

The Company

**Collections**  
 Marble Look  
**Concrete Look**  
 Stone Look  
 Metal Look  
 Wood Look  
 Cotto Look



**TH2.0**  
 Outdoor  
 Solutions

Bathroom furniture

Ventilated facades

Technical information

# H24

Forever young



WALL White 20x50 . 8"x20" | White Decoro H24 20x50 . 8"x20"  
FLOOR Moka 60x60 . 24"x24"



Concrete Look H24

General index

Product indexes

The Company

## Collections

Marble Look  
Concrete Look  
Stone Look  
Metal Look  
Wood Look  
Cotto Look



TH2.0  
Outdoor  
Solutions

Bathroom  
furniture

Ventilated  
facades

Technical  
information

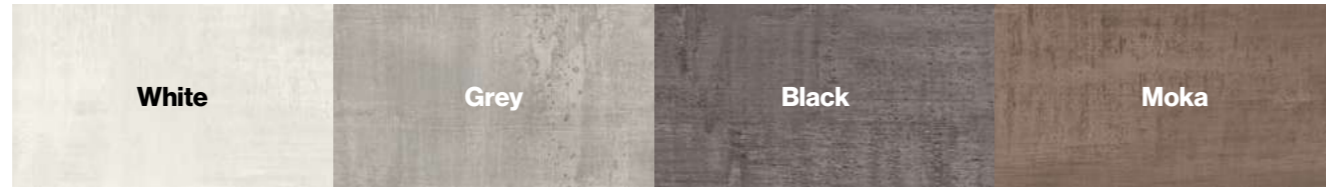

Size Formato	Finishes Finiture	Price code sqm Codice prezzo m <sup>2</sup>	White	Grey	Black	Moka
<b>60x60</b> 24"x24" ±9 mm	Rectified Rettificato	<b>139</b>				
<b>30x60</b> 12"x24" ±9 mm	Rectified Rettificato	<b>137</b>				
<b>BICOTTURA</b> <b>20x50</b> 8"x20" ±8 mm	Glossy Semilucido	<b>125</b>				
<b>BATTISCOPA</b> <b>7,5x60</b> 3"x24"	Rectified Rettificato	<b>106*</b>				

\* Price code / pc. Codice prezzo / pz.

## Decors.

Decori. Décor. Dekor.



White  
DECORO H24  
20x50 8"x20"  
±8 mm  
BICOTTURA  
Price code / sqm  
Codice prezzo / m<sup>2</sup>  
**130**



Grey  
DECORO H24  
20x50 8"x20"  
±8 mm  
BICOTTURA  
Price code / sqm  
Codice prezzo / m<sup>2</sup>  
**130**

**R9**  
Rectificato  
Rettificato  
Rectifié  
Rektifiziert  
**V3**

**Porcelain stoneware coloured in body**  
Gres porcellanato colorato in massa  
Grès cérame coloré dans la masse  
Eingefärbtes Feinsteinzeug

**Double firing**  
Bicottura  
Bicuisson  
Zweimalbrand

## Mosaics.

Mosaici. Mosaïques. Mosaik.



White  
MOSAICO 36PZ  
30x30 12"x12"  
NAT  
Price code / pc  
Codice prezzo / pz  
**110**



White  
MOSAICO ESAGONI  
26x30 10"x12"  
NAT  
Price code / pc  
Codice prezzo / pz  
**122**



Grey  
MOSAICO 36PZ  
30x30 12"x12"  
NAT  
Price code / pc  
Codice prezzo / pz  
**110**



Grey  
MOSAICO ESAGONI  
26x30 10"x12"  
NAT  
Price code / pc  
Codice prezzo / pz  
**122**



Black  
MOSAICO 36PZ  
30x30 12"x12"  
NAT  
Price code / pc  
Codice prezzo / pz  
**110**



Black  
MOSAICO ESAGONI  
26x30 10"x12"  
NAT  
Price code / pc  
Codice prezzo / pz  
**122**



Moka  
MOSAICO 36PZ  
30x30 12"x12"  
NAT  
Price code / pc  
Codice prezzo / pz  
**110**



Moka  
MOSAICO ESAGONI  
26x30 10"x12"  
NAT  
Price code / pc  
Codice prezzo / pz  
**122**



General  
index

Product  
indexes

The  
Company

## Collections

Marble Look  
Concrete Look  
Stone Look  
Metal Look  
Wood Look  
Cotto Look



TH2.0  
Outdoor  
Solutions

Bathroom  
furniture

Ventilated  
facades

Technical  
information



# Loft

Urban vocation



WALL Ash 120x280 . 48"x110"  
FLOOR Taupe 60x60 . 24"x24"



White

Cream

Taupe

Ash

Grey

General index

Product indexes

The Company

## Collections

Marble Look  
Concrete Look  
Stone Look  
Metal Look  
Wood Look  
Cotto Look











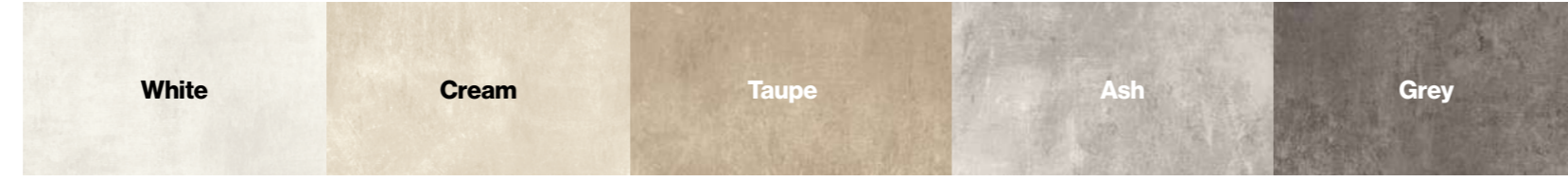







TH2.0  
Outdoor  
Solutions

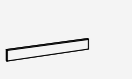

Bathroom  
furniture

Ventilated  
facades

Technical  
information



Size Formato	Finishes Finiture	Price code sqm Codice prezzo m <sup>2</sup>	White	Cream	Taupe	Ash	Grey
 <b>EKXTREME</b> 120x280 48"x110" ±6 mm	Rectified Rettificato	159		•	•	•	
 <b>120x120</b> 48"x48" ±9 mm	Rectified Rettificato	153	•	•	•	•	•
 <b>60x120</b> 24"x48" ±9 mm	Rectified Rettificato	144	•	•	•	•	•
	Antislip Sabbiato	145	•	•	•	•	•
 <b>80x80</b> 32"x32" ±9 mm	Rectified Rettificato	146	•	•	•	•	•
 <b>60x60</b> 24"x24" ±9 mm	Rectified Rettificato	139	•	•	•	•	•
 <b>30,8x61,5</b> 12"x24" ±9 mm	Natural Naturale	131	•	•	•	•	•
 <b>30x60</b> 12"x24" ±9 mm	Rectified Rettificato	137	•	•	•	•	•
 <b>BATTISCOPA</b> <b>6,5x120</b> 2 1/8"x48"	Rectified Rettificato	120 * 	•	•	•	•	•
 <b>BATTISCOPA</b> <b>7,5x80</b> 3"x32"	Rectified Rettificato	109 * 	•	•	•	•	•
 <b>BATTISCOPA</b> <b>7,5x61,5</b> 3"x24"	Natural Naturale	105 * 	•	•	•	•	•
 <b>BATTISCOPA</b> <b>7,5x60</b> 3"x24"	Rectified Rettificato	106 * 	•	•	•	•	•

TH2.0 OUTDOOR SOLUTIONS available    
 TH2.0 OUTDOOR SOLUTIONS disponibile 

\* Price code / pc. Codice prezzo / pz.

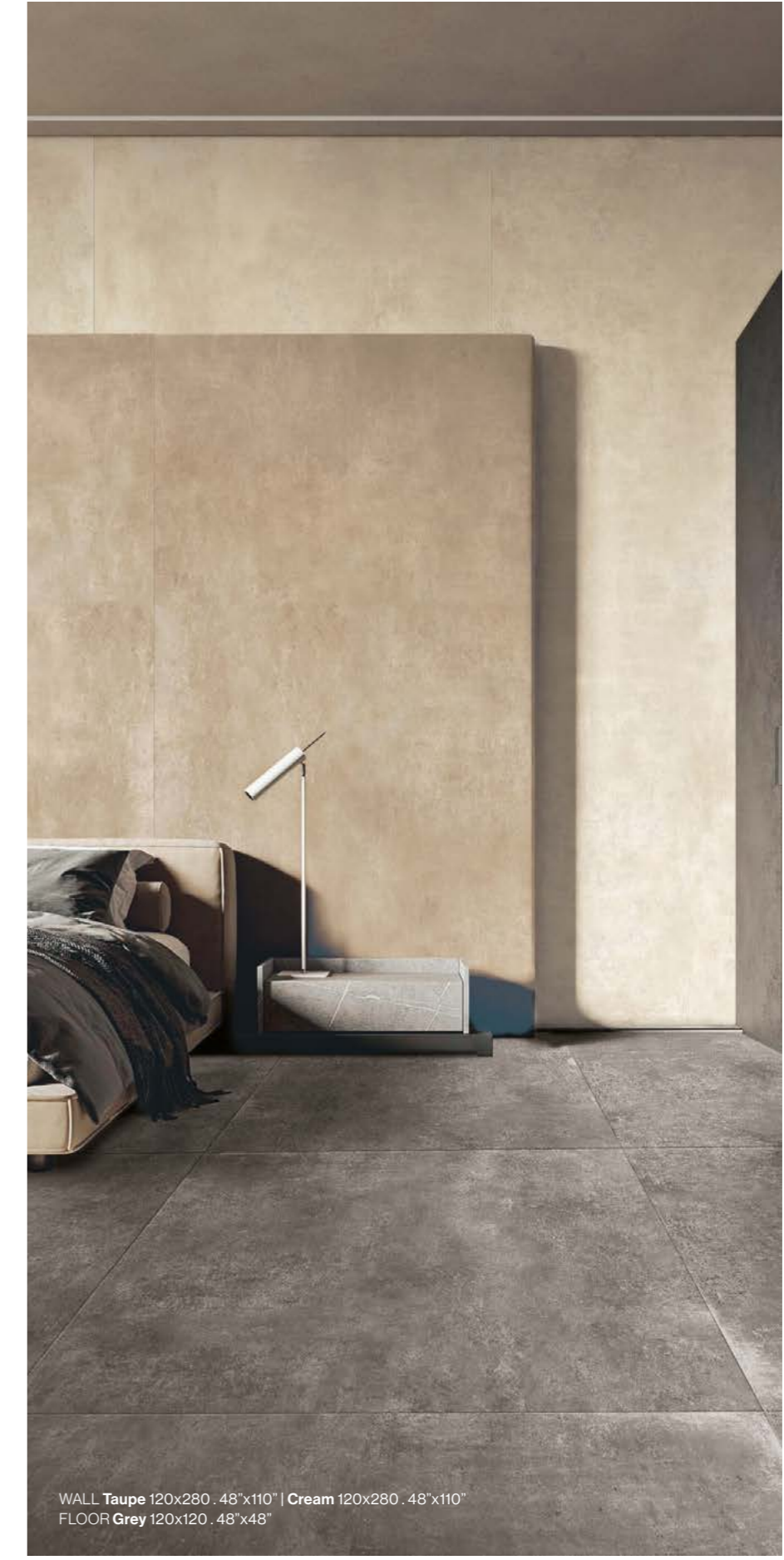

WALL **Taupe** 120x280 . 48"x110" | **Cream** 120x280 . 48"x110"  
 FLOOR **Grey** 120x120 . 48"x48"

General index

Product indexes

The Company

Collections

- Marble Look
- Concrete Look**
- Stone Look
- Metal Look
- Wood Look
- Cotto Look



TH2.0  
Outdoor  
Solutions

Bathroom  
furniture

Ventilated  
facades

Technical  
information



## Decors.

Decori. Décors. Dekore.



## 6

Themes  
Soggetti  
 Sujets  
Themen

DECORO GURU  
30x60 12"x24"  
±9 mm  
RETT  
Price code / sqm  
Codice prezzo / m<sup>2</sup>  
143

White  
DECORO GURU  
30x60 12"x24"  
±9 mm  
RETT  
Price code / sqm  
Codice prezzo / m<sup>2</sup>  
143



WALL White Decoro Guru 30x60 . 12"x24"



White  
DECORO WAVES  
30x60 12"x24"  
±9 mm  
RETT  
Price code / sqm  
Codice prezzo / m<sup>2</sup>  
142



Cream  
DECORO WAVES  
30x60 12"x24"  
±9 mm  
RETT  
Price code / sqm  
Codice prezzo / m<sup>2</sup>  
142



Taupe  
DECORO WAVES  
30x60 12"x24"  
±9 mm  
RETT  
Price code / sqm  
Codice prezzo / m<sup>2</sup>  
142



Ash  
DECORO WAVES  
30x60 12"x24"  
±9 mm  
RETT  
Price code / sqm  
Codice prezzo / m<sup>2</sup>  
142



Grey  
DECORO WAVES  
30x60 12"x24"  
±9 mm  
RETT  
Price code / sqm  
Codice prezzo / m<sup>2</sup>  
142

## Mosaics.

Mosaici. Mosaiques. Mosaik.



White  
MOSAICO 36PZ  
30x30 12"x12"  
NAT  
Price code / pc  
Codice prezzo / pz  
110



Cream  
MOSAICO 36PZ  
30x30 12"x12"  
NAT  
Price code / pc  
Codice prezzo / pz  
110



Taupe  
MOSAICO 36PZ  
30x30 12"x12"  
NAT  
Price code / pc  
Codice prezzo / pz  
110



Ash  
MOSAICO 36PZ  
30x30 12"x12"  
NAT  
Price code / pc  
Codice prezzo / pz  
110



Grey  
MOSAICO 36PZ  
30x30 12"x12"  
NAT  
Price code / pc  
Codice prezzo / pz  
110



# Massive

Continuity choice



WALL Oxidatio, Tellurium 120x280 - 48"x110"  
FLOOR Snow 120x120 - 48"x48"

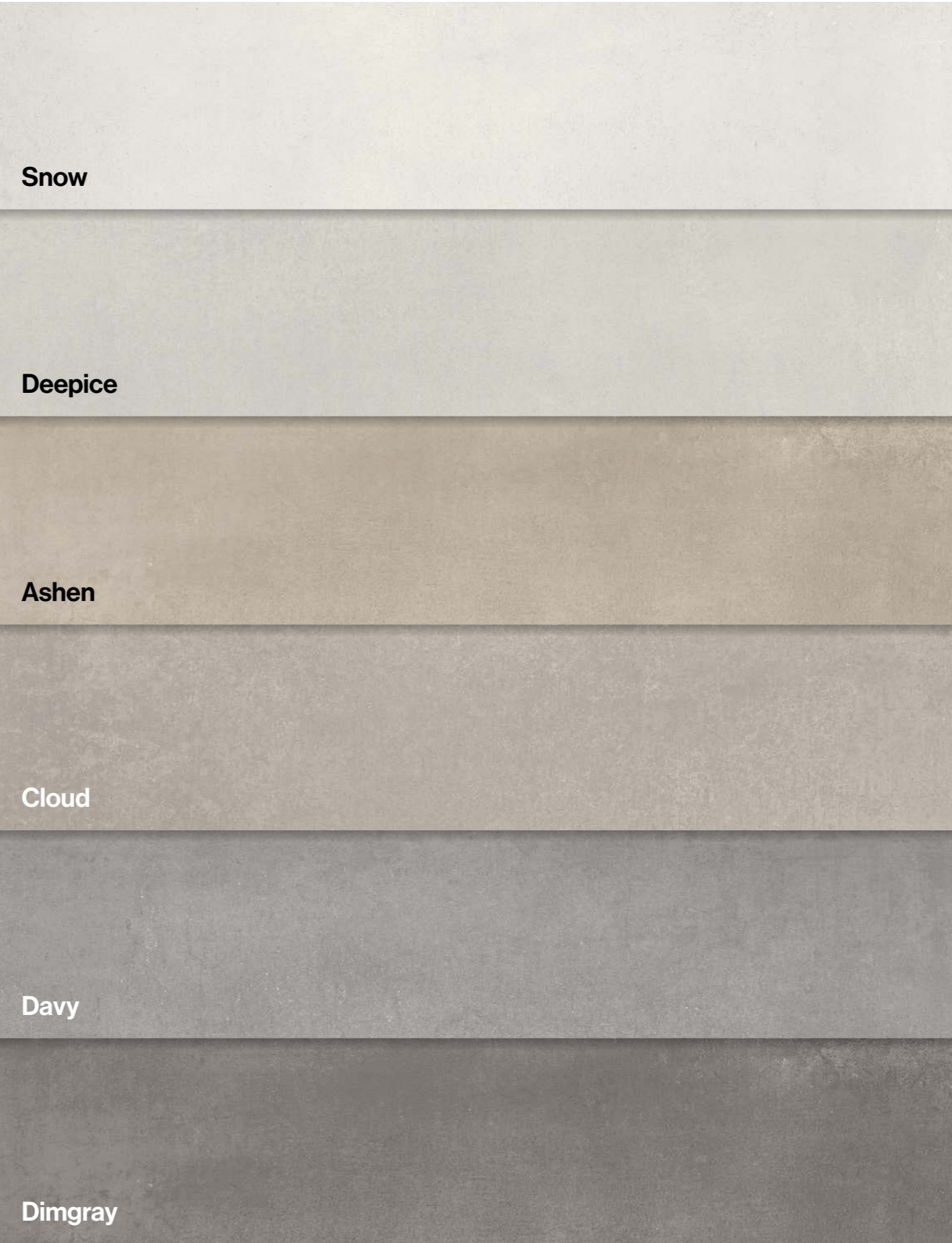

Snow

Deepice

Ashen

Cloud

Davy

Dimgray

General index

Product indexes

The Company

**Collections**  
Marble Look  
**Concrete Look**  
Stone Look  
Metal Look  
Wood Look  
Cotto Look



TH2.0  
Outdoor  
Solutions

Bathroom  
furniture

Ventilated  
facades

Technical  
information

# Massive

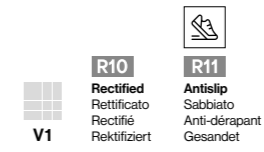

**Porcelain stoneware coloured in body**  
Gres porcellanato colorato in massa  
Grès cérame coloré dans la masse  
Eingefärbtes Feinsteinzeug

General index

Product indexes

The Company

Collections

Marble Look  
Concrete Look  
Stone Look  
Metal Look  
Wood Look  
Cotto Look



TH2.0  
Outdoor Solutions

Bathroom furniture

Ventilated facades

Technical information



Size Formato	Finishes Finiture	Price code sqm Codice prezzo m²	Snow	Deepice	Ashen	Cloud	Davy	Dimgray
<b>120x120</b> 48"x48" ±9 mm	Rectified Rettificato	153	•	•	•	•	•	•
<b>60x120</b> 24"x48" ±9 mm	Rectified Rettificato	144	•	•	•	•	•	•
	Antislip Sabbiato	145	•	•	•	•	•	•
<b>80x80</b> 32"x32" ±9 mm	Rectified Rettificato	146	•	•	•	•	•	
<b>60x60</b> 24"x24" ±9 mm	Rectified Rettificato	139	•	•	•	•	•	•
	Rectified Rettificato	137	•	•	•	•	•	
<b>BATTISCOPIA</b> <b>7,5x80</b> 3"x32"	Rectified Rettificato	109*	•	•	•	•	•	
<b>BATTISCOPIA</b> <b>7,5x60</b> 3"x24"	Rectified Rettificato	106*	•	•	•	•	•	

\* Price code / pc. Codice prezzo / pz.

## Mosaics.

Mosaici. Mosaïques. Mosaik.

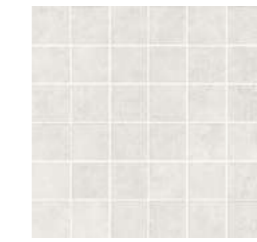

Snow  
MOSAICO 36PZ  
30x30 12"x12"  
NAT

Price code / pc  
Codice prezzo / pz  
**110**

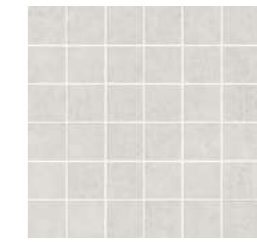

Deepice  
MOSAICO 36PZ  
30x30 12"x12"  
NAT

Price code / pc  
Codice prezzo / pz  
**110**



Ashen  
MOSAICO 36PZ  
30x30 12"x12"  
NAT

Price code / pc  
Codice prezzo / pz  
**110**



Cloud  
MOSAICO 36PZ  
30x30 12"x12"  
NAT

Price code / pc  
Codice prezzo / pz  
**110**



Davy  
MOSAICO 36PZ  
30x30 12"x12"  
NAT

Price code / pc  
Codice prezzo / pz  
**110**



Dimgray  
MOSAICO 36PZ  
30x30 12"x12"  
NAT

Price code / pc  
Codice prezzo / pz  
**110**



FLOOR Deepice 120x120 . 48"x48"



WALL Snow 120x120 . 48"x48"  
FLOOR Ashen 120x120 . 48"x48"

# Mood

Wide colour palette



WALL Rise 120x280 . 48"x110"  
FLOOR Pure 60x60 . 24"x24"



General index

Product indexes

The Company

### Collections

- Marble Look
- Concrete Look
- Stone Look
- Metal Look
- Wood Look
- Cotto Look



TH2.0  
Outdoor  
Solutions

Bathroom  
furniture

Ventilated  
facades

Technical  
information

# Mood

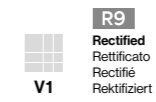

**Porcelain stoneware**  
Gres porcellanato  
Grès cérame coloré  
Feinsteinzeug

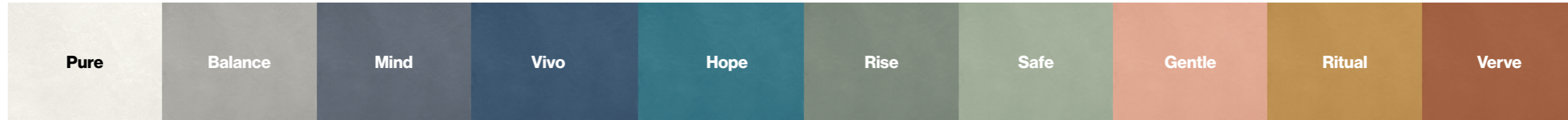

Size Formato	Finishes Finiture	Price code sqm Codice prezzo m <sup>2</sup>	Pure	Balance	Mind	Vivo	Hope	Rise	Safe	Gentle	Ritual	Verve
<b>EKTREME</b> 120x280 48"x110" ±6 mm	Rectified Rettificato	161	•	•	•	•	•	•	•	•	•	•
<b>60x120</b> 24"x48" ±9 mm	Rectified Rettificato	148	•	•	•	•	•	•	•	•	•	•
<b>60x60</b> 24"x24" ±9 mm	Rectified Rettificato	141	•	•	•	•	•	•	•	•	•	•
<b>BATTISCOPIA</b> 6,5x120 2 1/8"x48"	Rectified Rettificato	120*	•	•	•	•	•	•	•	•	•	•

\* Price code / pc. Codice prezzo / pz.



WALL **Verve** 120x280 . 48"x110" | **Ritual** 120x280 . 48"x110"  
FURNITURE **Ritual** 120x280 . 48"x110"  
FLOOR **Medley, Cream** 120x120 . 48"x48"

## Mosaics.

Mosaici. Mosaïques. Mosaik.

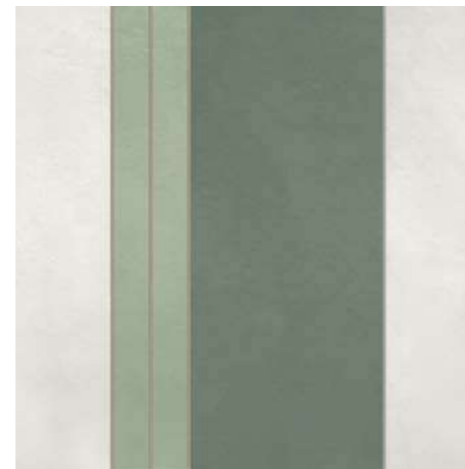

Mint  
MOSAICO BLENDER  
60x60 24"x24"  
NAT

Price code / pc  
Codice prezzo / pz  
**164**



Warm  
MOSAICO BLENDER  
60x60 24"x24"  
NAT

Price code / pc  
Codice prezzo / pz  
**164**

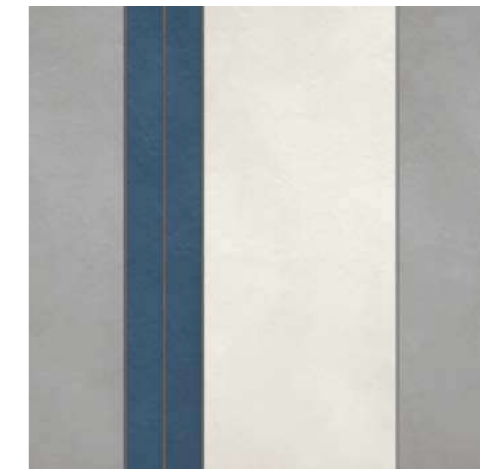

Cool  
MOSAICO BLENDER  
60x60 24"x24"  
NAT

Price code / pc  
Codice prezzo / pz  
**164**



## 3

**Themes sorted by colour**  
Soggetti per colore  
Sujets par couleur  
Themen nach farbe

Concrete Look Mood

General  
index

Product  
indexes

The  
Company

## Collections

Marble Look  
**Concrete Look**  
Stone Look  
Metal Look  
Wood Look  
Cotto Look



TH2.0  
Outdoor  
Solutions

Bathroom  
furniture

Ventilated  
facades

Technical  
information

# Mood

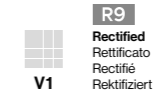

**Porcelain stoneware**  
Gres porcellanato  
Grès cérame coloré  
Feinsteinzeug

## Mosaics.

Mosaici. Mosaiques. Mosaik.



Pure  
MOSAICO 36PZ  
30x30 12"x12"  
NAT

Price code / pc  
Codice prezzo / pz  
**110**

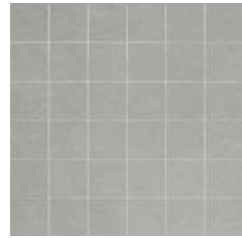

Balance  
MOSAICO 36PZ  
30x30 12"x12"  
NAT

Price code / pc  
Codice prezzo / pz  
**110**

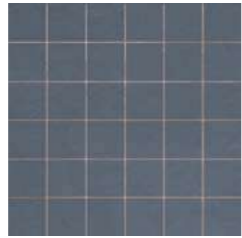

Mind  
MOSAICO 36PZ  
30x30 12"x12"  
NAT

Price code / pc  
Codice prezzo / pz  
**110**

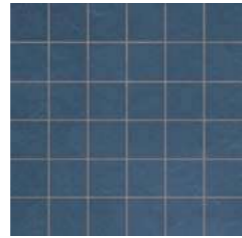

Vivo  
MOSAICO 36PZ  
30x30 12"x12"  
NAT

Price code / pc  
Codice prezzo / pz  
**110**

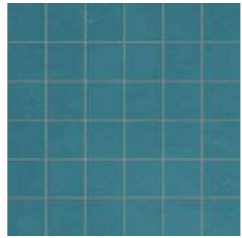

Hope  
MOSAICO 36PZ  
30x30 12"x12"  
NAT

Price code / pc  
Codice prezzo / pz  
**110**

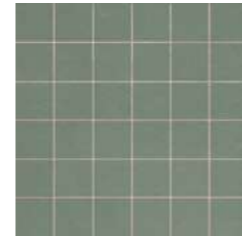

Rise  
MOSAICO 36PZ  
30x30 12"x12"  
NAT

Price code / pc  
Codice prezzo / pz  
**110**

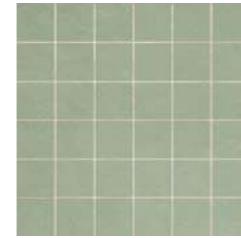

Safe  
MOSAICO 36PZ  
30x30 12"x12"  
NAT

Price code / pc  
Codice prezzo / pz  
**110**

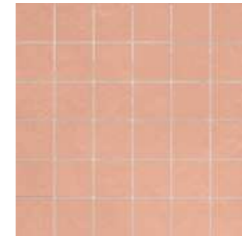

Gentle  
MOSAICO 36PZ  
30x30 12"x12"  
NAT

Price code / pc  
Codice prezzo / pz  
**110**

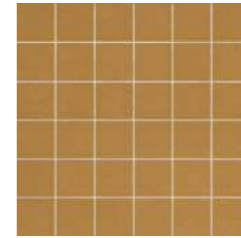

Ritual  
MOSAICO 36PZ  
30x30 12"x12"  
NAT

Price code / pc  
Codice prezzo / pz  
**110**

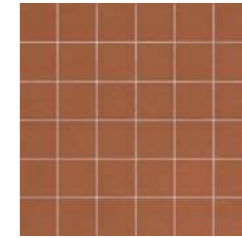

Verve  
MOSAICO 36PZ  
30x30 12"x12"  
NAT

Price code / pc  
Codice prezzo / pz  
**110**



Pure  
MOSAICO ESAGONI  
26x30 10"x12"  
NAT

Price code / pc  
Codice prezzo / pz  
**122**



Balance  
MOSAICO ESAGONI  
26x30 10"x12"  
NAT

Price code / pc  
Codice prezzo / pz  
**122**

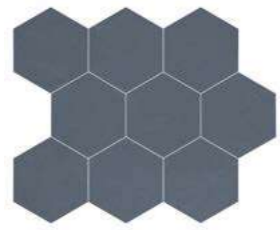

Mind  
MOSAICO ESAGONI  
26x30 10"x12"  
NAT

Price code / pc  
Codice prezzo / pz  
**122**



Vivo  
MOSAICO ESAGONI  
26x30 10"x12"  
NAT

Price code / pc  
Codice prezzo / pz  
**122**



Hope  
MOSAICO ESAGONI  
26x30 10"x12"  
NAT

Price code / pc  
Codice prezzo / pz  
**122**



Rise  
MOSAICO ESAGONI  
26x30 10"x12"  
NAT

Price code / pc  
Codice prezzo / pz  
**122**

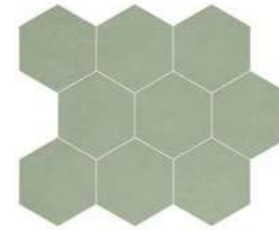

Safe  
MOSAICO ESAGONI  
26x30 10"x12"  
NAT

Price code / pc  
Codice prezzo / pz  
**122**

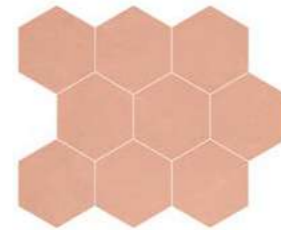

Gentle  
MOSAICO ESAGONI  
26x30 10"x12"  
NAT

Price code / pc  
Codice prezzo / pz  
**122**

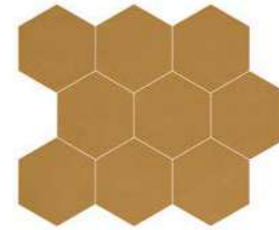

Ritual  
MOSAICO ESAGONI  
26x30 10"x12"  
NAT

Price code / pc  
Codice prezzo / pz  
**122**

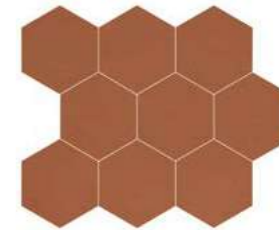

Verve  
MOSAICO ESAGONI  
26x30 10"x12"  
NAT

Price code / pc  
Codice prezzo / pz  
**122**



Pure  
MOSAICO BISCUIT  
19x34 7"x13"  
NAT

Price code / pc  
Codice prezzo / pz  
**141**



Balance  
MOSAICO BISCUIT  
19x34 7"x13"  
NAT

Price code / pc  
Codice prezzo / pz  
**141**



Mind  
MOSAICO BISCUIT  
19x34 7"x13"  
NAT

Price code / pc  
Codice prezzo / pz  
**141**



Vivo  
MOSAICO BISCUIT  
19x34 7"x13"  
NAT

Price code / pc  
Codice prezzo / pz  
**141**

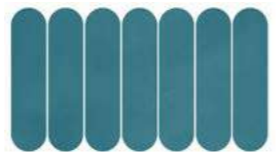

Hope  
MOSAICO BISCUIT  
19x34 7"x13"  
NAT

Price code / pc  
Codice prezzo / pz  
**141**



Rise  
MOSAICO BISCUIT  
19x34 7"x13"  
NAT

Price code / pc  
Codice prezzo / pz  
**141**



Safe  
MOSAICO BISCUIT  
19x34 7"x13"  
NAT

Price code / pc  
Codice prezzo / pz  
**141**



Gentle  
MOSAICO BISCUIT  
19x34 7"x13"  
NAT

Price code / pc  
Codice prezzo / pz  
**141**



Ritual  
MOSAICO BISCUIT  
19x34 7"x13"  
NAT

Price code / pc  
Codice prezzo / pz  
**141**

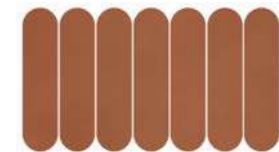

Verve  
MOSAICO BISCUIT  
19x34 7"x13"  
NAT

Price code / pc  
Codice prezzo / pz  
**141**





# Parker

Concrete that lasts



FLOOR Silver 120x120 . 48"x48"

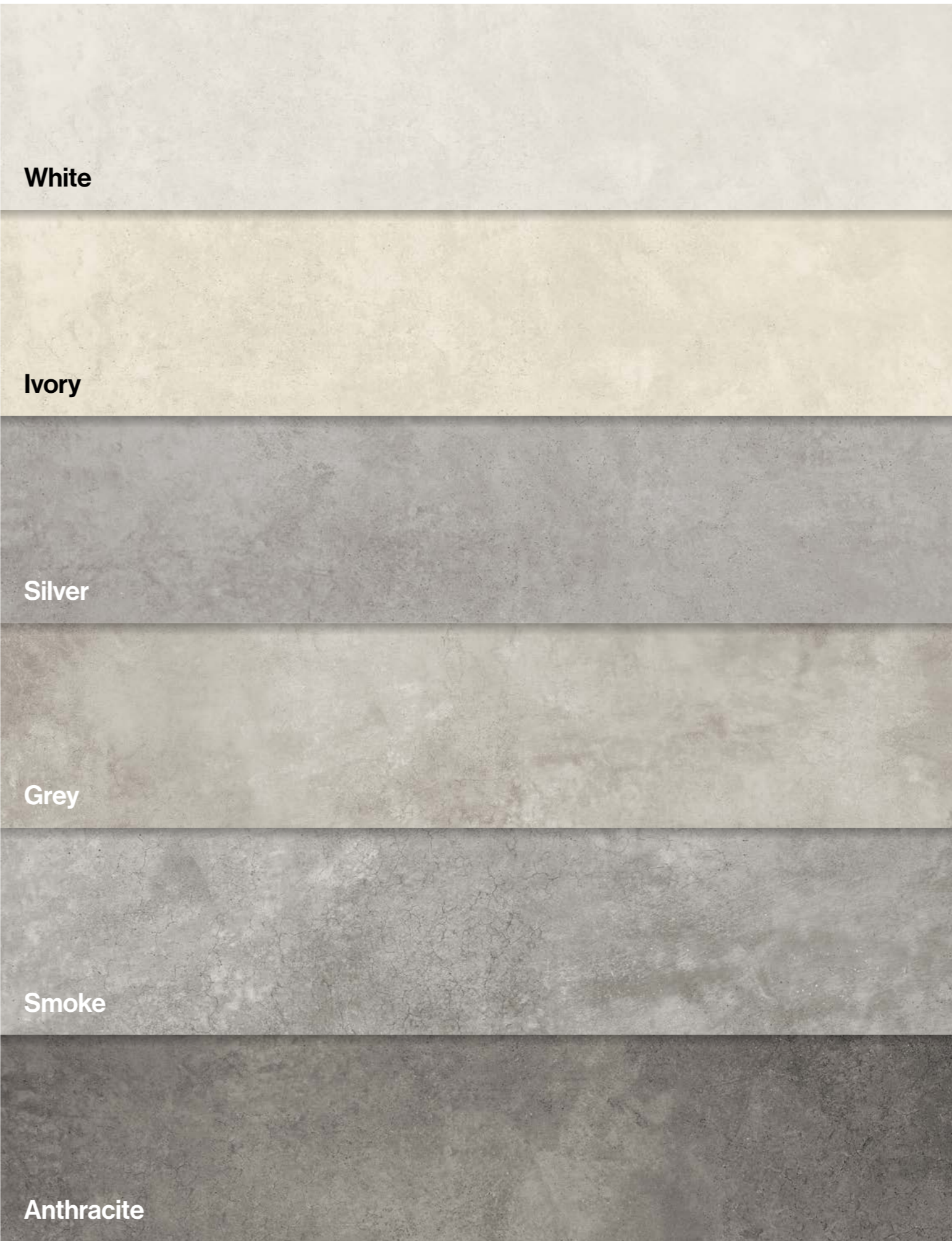

White

Ivory

Silver

Grey

Smoke

Anthracite

General index

Product indexes

The Company

### Collections

- Marble Look
- Concrete Look**
- Stone Look
- Metal Look
- Wood Look
- Cotto Look



TH2.0  
Outdoor  
Solutions

Bathroom  
furniture

Ventilated  
facades

Technical  
information



Size Formato	Finishes Finiture	Price code sqm Codice prezzo m <sup>2</sup>	White	Ivory	Silver	Grey	Smoke	Anthracite
<b>EKTREME</b> <b>120x280</b> 48"x110" →6 mm	Rectified Rettificato	159	•		•	•		
<b>120x120</b> 48"x48" →9 mm	Rectified Rettificato	153	•	•	•	•	•	•
<b>60x120</b> 24"x48" →9 mm	Rectified Rettificato	144	•	•	•	•	•	•
	Antislip Sabbiato	145	•	•	•	•	•	•
<b>80x80</b> 32"x32" →9 mm	Rectified Rettificato	146	•	•	•	•	•	•
<b>60x60</b> 24"x24" →9 mm	Rectified Rettificato	139	•	•	•	•	•	•
<b>30x60</b> 12"x24" →9 mm	Rectified Rettificato	137	•	•	•	•	•	•
<b>BATTISCOPA</b> <b>6,5x120</b> 2 1/2"x48"	Rectified Rettificato	120*	•	•	•	•	•	•
<b>BATTISCOPA</b> <b>7,5x80</b> 3"x32"	Rectified Rettificato	109*	•	•	•	•	•	•
<b>BATTISCOPA</b> <b>7,5x60</b> 3"x24"	Rectified Rettificato	106*	•	•	•	•	•	•

TH2.0 OUTDOOR SOLUTIONS available

TH2.0 OUTDOOR SOLUTIONS disponibile

\* Price code / pc. Codice prezzo / pz.



## Mosaics.

Mosaici. Mosaiques. Mosaik.



White  
MOSAICO 36PZ  
30x30 12"x12"  
NAT

Price code / pc  
Codice prezzo / pz  
**110**



Ivory  
MOSAICO 36PZ  
30x30 12"x12"  
NAT

Price code / pc  
Codice prezzo / pz  
**110**



Silver  
MOSAICO 36PZ  
30x30 12"x12"  
NAT

Price code / pc  
Codice prezzo / pz  
**110**



Grey  
MOSAICO 36PZ  
30x30 12"x12"  
NAT

Price code / pc  
Codice prezzo / pz  
**110**



Smoke  
MOSAICO 36PZ  
30x30 12"x12"  
NAT

Price code / pc  
Codice prezzo / pz  
**110**



Anthracite  
MOSAICO 36PZ  
30x30 12"x12"  
NAT

Price code / pc  
Codice prezzo / pz  
**110**



WALL Grey 120x280 . 48"x110" | Grey Mosaico 36 pz. 30x30 . 12"x12"  
 FLOOR Anthracite 60x120 . 24"x48" | Anthracite Mosaico 36 pz. 30x30 . 12"x12"

General index

Product indexes

The Company

### Collections

Marble Look  
**Concrete Look**  
 Stone Look  
 Metal Look  
 Wood Look  
 Cotto Look



TH2.0  
 Outdoor  
 Solutions

Bathroom furniture

Ventilated facades

Technical information

# Res-Terrae

Natural mood



WALL Saffron 120x120 . 48"x48" | Cotton 120x120 . 48"x48"  
FLOOR Corn 120x120 . 48"x48"

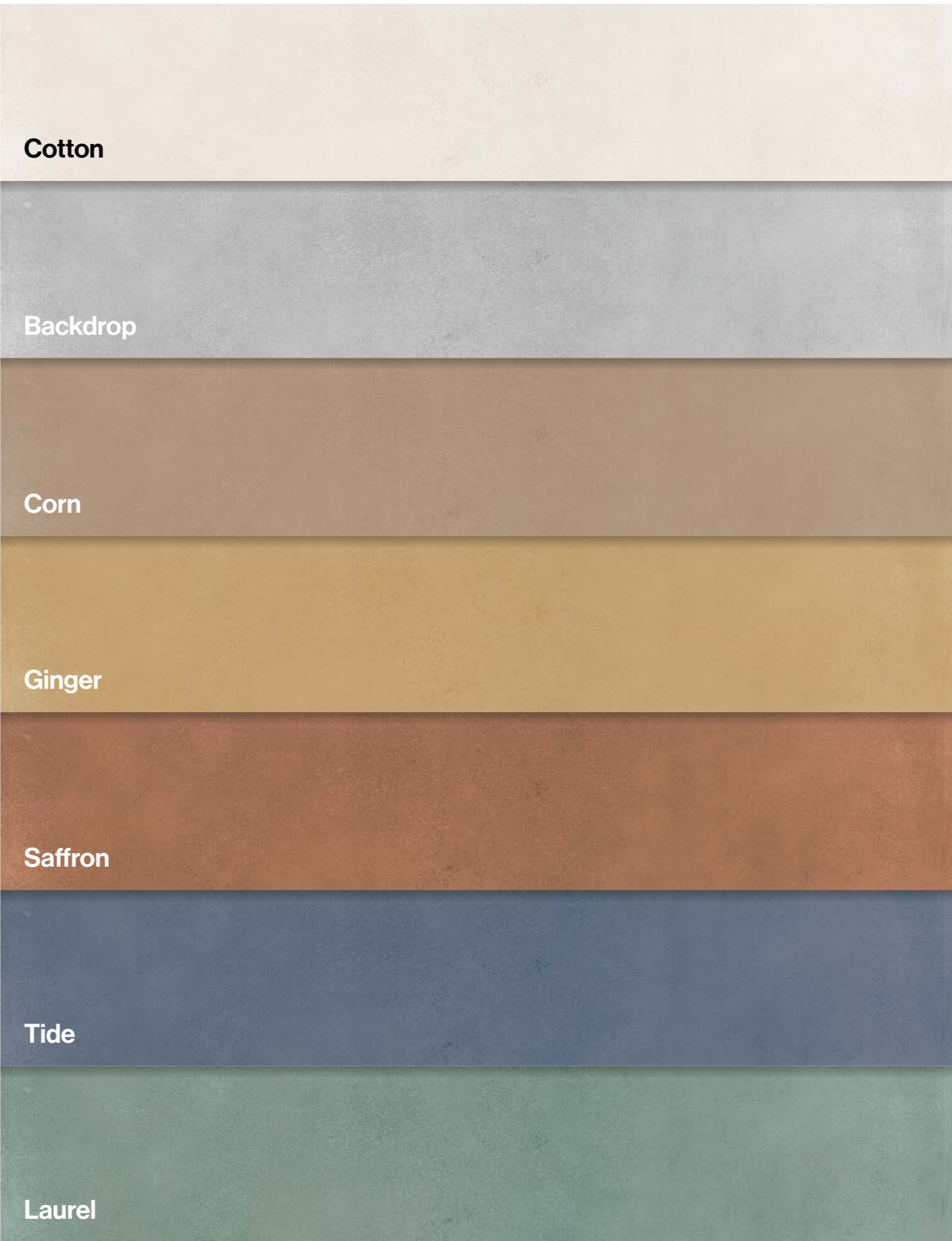

Cotton

Backdrop

Corn

Ginger

Saffron

Tide

Laurel

General index

Product indexes

The Company

### Collections

- Marble Look
- Concrete Look
- Stone Look
- Metal Look
- Wood Look
- Cotto Look



TH2.0  
Outdoor  
Solutions

Bathroom  
furniture

Ventilated  
facades

Technical  
information

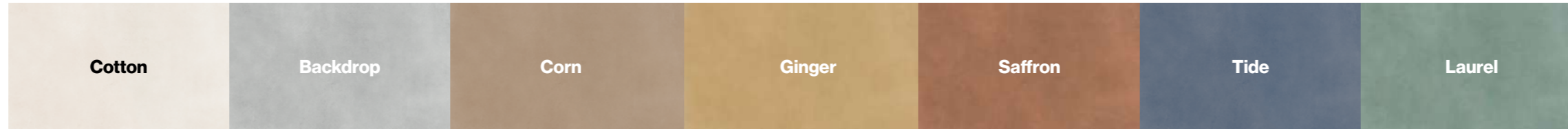

Size Formato	Finishes Finiture	Price code sqm Codice prezzo m <sup>2</sup>	Cotton	Backdrop	Corn	Ginger	Saffron	Tide	Laurel
<b>120x120</b> 48"x48" ±9 mm	Rectified Rettificato	153	•	•	•	•	•	•	•
<b>60x120</b> 24"x48" ±9 mm	Rectified Rettificato	144	•	•	•	•	•	•	•
<b>80x80</b> 32"x32" ±9 mm	Rectified Rettificato	146	•	•	•				
<b>60x60</b> 24"x24" ±9 mm	Rectified Rettificato	139	•	•	•	•	•	•	•
GROOVE <b>60x120</b> 24"x48" ±9 mm	Rectified Rettificato	151	•	•	•	•	•	•	•
BATTISCOPIA <b>6,5x120</b> 2 1/8"x48"	Rectified Rettificato	120*	•	•	•	•	•	•	•
BATTISCOPIA <b>7,5x80</b> 3"x32"	Rectified Rettificato	109*	•	•	•	•	•	•	•
BATTISCOPIA <b>7,5x60</b> 3"x24"	Rectified Rettificato	106*	•	•	•	•	•	•	•

\* Price code / pc. Codice prezzo / pz.



# Res-Terrae

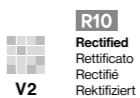

**Porcelain stoneware coloured in body**  
 Gres porcellanato colorato in massa  
 Grès cérame coloré dans la masse  
 Eingefärbtes Feinsteinzeug

### 3D Groove texture.

Struttura 3D Groove. Structure 3D Groove. 3D Groove Textur.



Cotton  
GROOVE  
60x120 24"x48"  
±9 mm  
RETT



Backdrop  
GROOVE  
60x120 24"x48"  
±9 mm  
RETT



Corn  
GROOVE  
60x120 24"x48"  
±9 mm  
RETT



Ginger  
GROOVE  
60x120 24"x48"  
±9 mm  
RETT



Saffron  
GROOVE  
60x120 24"x48"  
±9 mm  
RETT



Tide  
GROOVE  
60x120 24"x48"  
±9 mm  
RETT

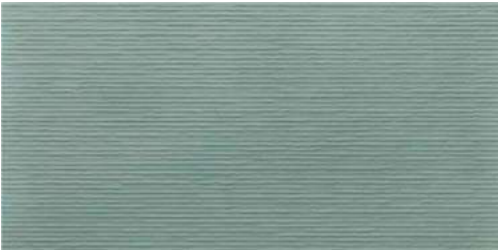

Laurel  
GROOVE  
60x120 24"x48"  
±9 mm  
RETT



WALL Tide Groove 60x120 . 24"x48"  
 FLOOR Cotton 120x120 . 48"x48"

### Mosaics.

Mosaici. Mosaïques. Mosaik.

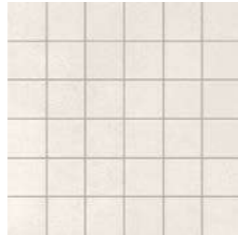

Cotton  
MOSAICO 36PZ  
30x30 12"x12"  
NAT  
Price code / pc  
Codice prezzo / pz  
110



Backdrop  
MOSAICO 36PZ  
30x30 12"x12"  
NAT  
Price code / pc  
Codice prezzo / pz  
110



Corn  
MOSAICO 36PZ  
30x30 12"x12"  
NAT  
Price code / pc  
Codice prezzo / pz  
110



Ginger  
MOSAICO 36PZ  
30x30 12"x12"  
NAT  
Price code / pc  
Codice prezzo / pz  
110



Saffron  
MOSAICO 36PZ  
30x30 12"x12"  
NAT  
Price code / pc  
Codice prezzo / pz  
110



Tide  
MOSAICO 36PZ  
30x30 12"x12"  
NAT  
Price code / pc  
Codice prezzo / pz  
110

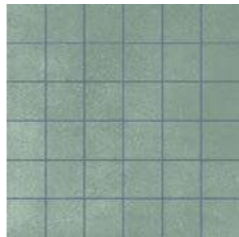

Laurel  
MOSAICO 36PZ  
30x30 12"x12"  
NAT  
Price code / pc  
Codice prezzo / pz  
110



# Select

Shades of greige



FLOOR Fumo 60x120 . 24"x48"

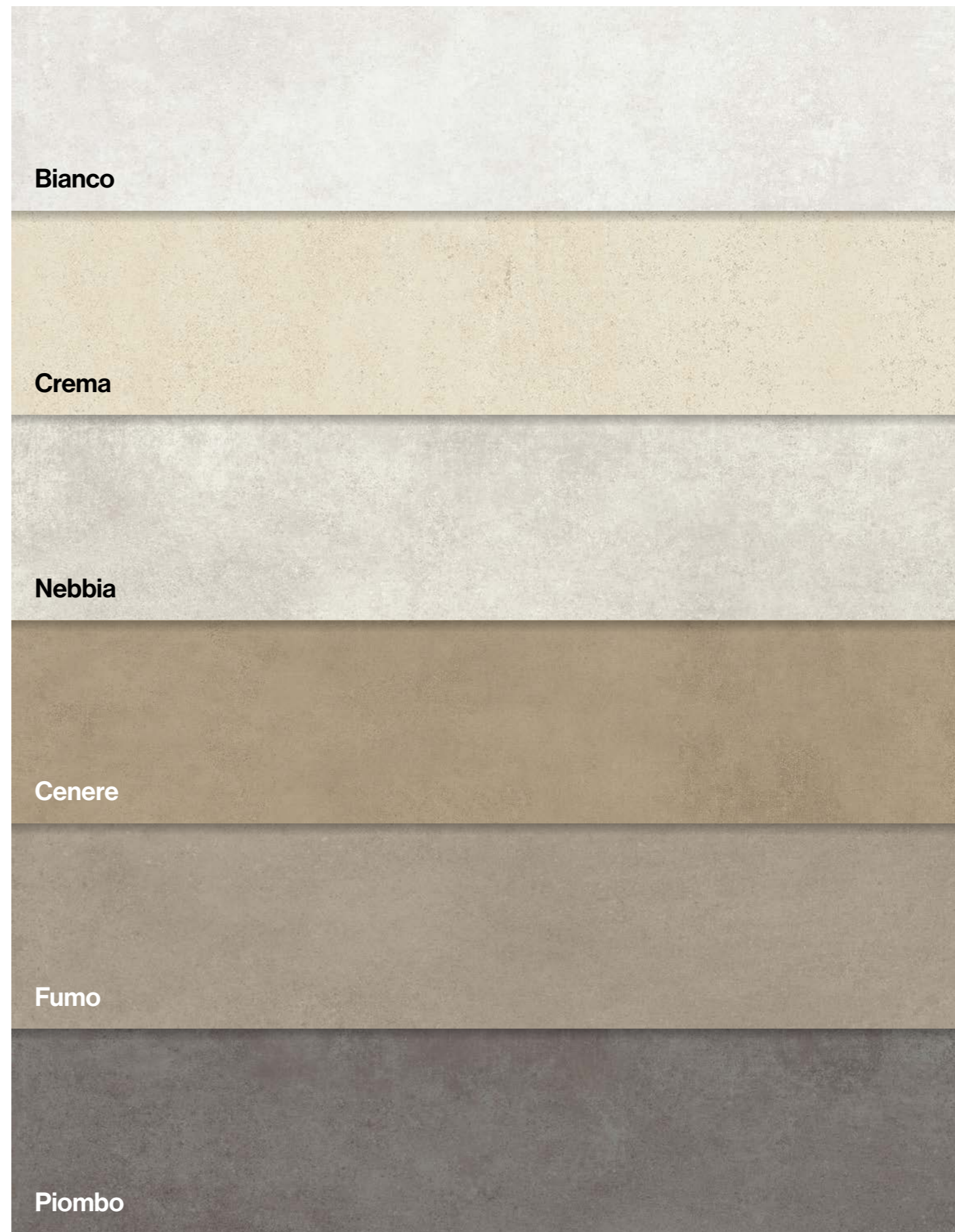

Bianco

Crema

Nebbia

Cenere

Fumo

Piombo

General index

Product indexes

The Company

## Collections

Marble Look  
Concrete Look  
Stone Look  
Metal Look  
Wood Look  
Cotto Look



TH2.0  
Outdoor  
Solutions

Bathroom  
furniture

Ventilated  
facades

Technical  
information

# Select

HiSense

UPEC

V1

R10  
Rectified  
Rettificato  
Rectifié  
Rektifiziert

R11  
Antislip  
Sabbliato  
Anti-dérapant  
Gesandnet

Porcelain stoneware coloured in body  
Gres porcellanato colorato in massa  
Grès cérame coloré dans la masse  
Eingefärbtes Feinsteinzeug

Double firing  
Bicottura  
Bicuisson  
Zweimalbrand

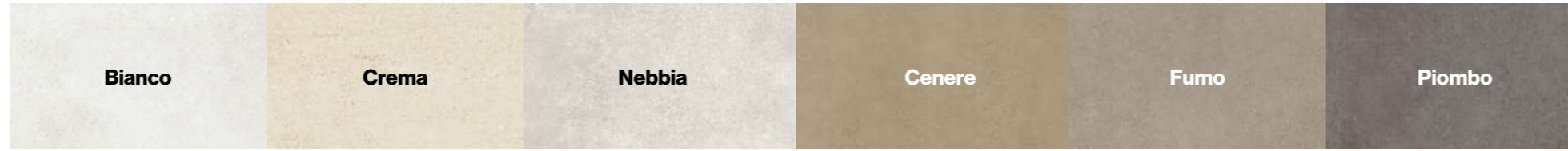

Size Formato	Finishes Finiture	Price code sqm Codice prezzo m <sup>2</sup>	Bianco	Crema	Nebbia	Cenere	Fumo	Piombo
<b>120x120</b> 48"x48" ⇒9 mm	Rectified Rettificato	153	•	•	•	•	•	•
<b>60x120</b> 24"x48" ⇒9 mm	Rectified Rettificato	144	•	•	•	•	•	•
<b>80x80</b> 32"x32" ⇒9 mm	Rectified Rettificato	146	•	•	•	•	•	•
<b>60x60</b> 24"x24" ⇒9 mm	Rectified Rettificato	139	•	•	•	•	•	•
<b>30x60</b> 12"x24" ⇒9 mm	Rectified Rettificato	137	•	•	•	•	•	•
	Antislip Sabbliato	138	•	•	•	•	•	•
<b>BICOTTURA</b> <b>20x50</b> 8"x20" ⇒8 mm	Matt Opaco	125	•	•	•	•	•	•
<b>BATTISCOPIA</b> <b>7,5x80</b> 3"x32"	Rectified Rettificato	109*	•	•	•	•	•	•
<b>BATTISCOPIA</b> <b>7,5x60</b> 3"x24"	Rectified Rettificato	106*	•	•	•	•	•	•

\* Price code / pc. Codice prezzo / pz.





# Select

**V1**

**R10**  
Rectified  
Rettificato  
Rectifié  
Rektifiziert

**R11**  
Antislip  
Sabbaiato  
Anti-dérapant  
Gesandnet

**Porcelain stoneware coloured in body**  
Gres porcellanato colorato in massa  
Grès cérame coloré dans la masse  
Eingefärbtes Feinsteinzeug

**Bicottura**  
Double firing  
Bicuisson  
Zweimalbrand

## Mosaics.

Mosaici. Mosaïques. Mosaik.

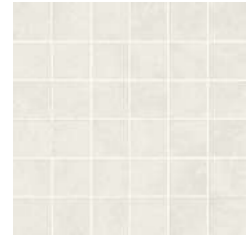

Bianco  
MOSAICO 36PZ  
30x30 12"x12"  
NAT  
Price code / pc  
Codice prezzo / pz  
**110**

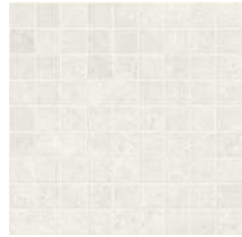

Bianco  
MOSAICO 81PZ  
30x30 12"x12"  
NAT  
Price code / pc  
Codice prezzo / pz  
**114**



Crema  
MOSAICO 36PZ  
30x30 12"x12"  
NAT  
Price code / pc  
Codice prezzo / pz  
**110**



Crema  
MOSAICO 81PZ  
30x30 12"x12"  
NAT  
Price code / pc  
Codice prezzo / pz  
**114**



Nebbia  
MOSAICO 36PZ  
30x30 12"x12"  
NAT  
Price code / pc  
Codice prezzo / pz  
**110**



Nebbia  
MOSAICO 81PZ  
30x30 12"x12"  
NAT  
Price code / pc  
Codice prezzo / pz  
**114**



Cenere  
MOSAICO 36PZ  
30x30 12"x12"  
NAT  
Price code / pc  
Codice prezzo / pz  
**110**

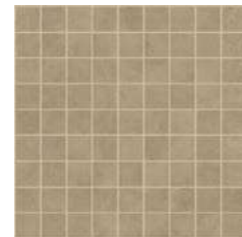

Cenere  
MOSAICO 81PZ  
30x30 12"x12"  
NAT  
Price code / pc  
Codice prezzo / pz  
**114**



Fumo  
MOSAICO 36PZ  
30x30 12"x12"  
NAT  
Price code / pc  
Codice prezzo / pz  
**110**

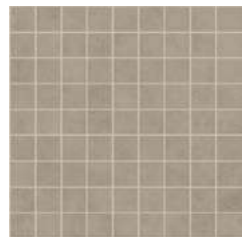

Fumo  
MOSAICO 81PZ  
30x30 12"x12"  
NAT  
Price code / pc  
Codice prezzo / pz  
**114**



Piombo  
MOSAICO 36PZ  
30x30 12"x12"  
NAT  
Price code / pc  
Codice prezzo / pz  
**110**

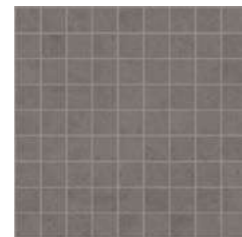

Piombo  
MOSAICO 81PZ  
30x30 12"x12"  
NAT  
Price code / pc  
Codice prezzo / pz  
**114**



WALL **Nebbia** 60x120 . 24"x48" | **Woodwise Fluted** 120x280 . 48"x110"  
FLOOR **Piombo** 120x120 . 48"x48"

General  
index

Product  
indexes

The  
Company

## Collections

Marble Look  
**Concrete Look**  
Stone Look  
Metal Look  
Wood Look  
Cotto Look



TH2.0  
Outdoor  
Solutions

Bathroom  
furniture

Ventilated  
facades

Technical  
information

# Unicolors

Living colors



FLOOR Tania 20x20 .8"x8" | Grigio 20x20 .8"x8"



Brillo

Azzurro

Tania

Verde

Ghiaccio

Giallo

Panna

Arancio

Grigio

General index

Product indexes

The Company

**Collections**  
Marble Look  
**Concrete Look**  
Stone Look  
Metal Look  
Wood Look  
Cotto Look



TH2.0  
Outdoor  
Solutions

Bathroom  
furniture

Ventilated  
facades

Technical  
information



Size Formato	Finishes Finiture	Price code sqm Codice prezzo m <sup>2</sup>	Brillo	Tania	Ghiaccio	Panna	Grigio
<input type="checkbox"/> <b>BICOTTURA</b> <b>20x20</b> 8"x8" ⇒ 6,5 mm	Glossy Lucido	125	•				
	Matt Opaco	125		•			
<input type="checkbox"/> <b>20x20</b> 8"x8" ⇒ 7,2 mm	Natural Naturale <b>R9</b>	134			•	•	•
	Natural Naturale <b>R10</b>	139			•	•	•



Size Formato	Finishes Finiture	Price code sqm Codice prezzo m <sup>2</sup>	Azzurro	Verde	Giallo	Arancio
<input type="checkbox"/> <b>20x20</b> 8"x8" ⇒ 7,2 mm	Natural Naturale <b>R9</b>	134	•	•	•	•
	Natural Naturale <b>R10</b>	139	•	•	•	•

General index

Product indexes

The Company

**Collections**

- Marble Look
- Concrete Look**
- Stone Look
- Metal Look
- Wood Look
- Cotto Look



TH2.0  
Outdoor  
Solutions

Bathroom  
furniture

Ventilated  
facades

Technical  
information

# Wallart

Natural inspiration decors



WALL Herbarium 60x120, 24"x48"



General index

Product indexes

The Company

**Collections**  
Marble Look  
Concrete Look  
Stone Look  
Metal Look  
Wood Look  
Cotto Look



TH2.0  
Outdoor  
Solutions

Bathroom  
furniture

Ventilated  
facades

Technical  
information



Size Formato	Finishes Finiture	Price code sqm Codice prezzo m <sup>2</sup>
60x120 24"x48" ±9 mm	Rectified Rettificato	160



WALL Majorelle 60x120 . 24"x48"



WALL Glam 60x120 . 24"x48"



WALL Flowerin 60x120 . 24"x48"



WALL Lily 60x120 . 24"x48"

**Developments.**  
Sviluppi. Développements. Entwicklungen.

**One Pattern**  
Soggetti singoli  
Motifs uniques  
Einzeldekore



Kamou  
60x120 24"x48"



Panama  
60x120 24"x48"



Glam  
60x120 24"x48"



Flowerin  
60x120 24"x48"



Majorelle  
60x120 24"x48"



Herbarium  
60x120 24"x48"



Lily  
60x120 24"x48"



Jamie  
60x120 24"x48"



WALL Glam 60x120 24"x48"

Concrete Look Wallart

General index

Product indexes

The Company

**Collections**  
Marble Look  
Concrete Look  
Stone Look  
Metal Look  
Wood Look  
Cotto Look



TH2.0  
Outdoor Solutions

Bathroom furniture

Ventilated facades

Technical information

# Index A - Z

Indice A - Z. Index A - Z. Alphabetisches Verzeichnis.

**Agathòs**  
**Cardosia**  
**Ceppo di Grè**  
**Fitch**  
**Genesis**  
**Heritage**  
**Hollstone**  
**Loop**  
**Medley**  
**Nereidi**  
**Pennslate**  
**Pietra di Vals**  
**Quarzi**  
**Rushmore**  
**Spark**  
**Sunstone**  
**Urano**  
**Utah**  
**Wonder**

# Stone Look

**General  
index**

**Product  
indexes**

**The  
Company**

## **Collections**

Marble Look  
Concrete Look  
**Stone Look**  
Metal Look  
Wood Look  
Cotto Look



**TH2.0  
Outdoor  
Solutions**

**Bathroom  
furniture**

**Ventilated  
facades**

**Technical  
information**

# Agathòs

Rare inspiration



WALL Anthracite 120x280 . 48"x110"  
FURNITURE White 120x280 . 48"x110"  
FLOOR Anthracite 120x120 . 48"x48"



White

Grey

Multicolor

Anthracite

General index

Product indexes

The Company

## Collections

Marble Look  
Concrete Look  
**Stone Look**  
Metal Look  
Wood Look  
Cotto Look



TH2.0  
Outdoor  
Solutions

Bathroom  
furniture

Ventilated  
facades

Technical  
information



# Agathòs



Size Formato	Finishes Finiture	Price code sqm Codice prezzo m <sup>2</sup>	•	•	•	•
<b>EKTREME</b> 120x280 48"x110" ±6 mm	Rectified Rettificato	159	•	•	•	•
<b>120x120</b> 48"x48" ±9 mm	Rectified Rettificato	153	•	•	•	•
<b>60x120</b> 24"x48" ±9 mm	Rectified Rettificato	144	•	•	•	•
<b>60x60</b> 24"x24" ±9 mm	Rectified Rettificato	139	•	•	•	•
<b>60x60</b> 24"x24" ±9 mm	Antislip Sabbiato	140	•	•	•	•
<b>30x60</b> 12"x24" ±9 mm	Rectified Rettificato	137	•	•	•	•
<b>9,9x30,2</b> 4"x12" ±9 mm	Rectified Rettificato	152	•	•	•	•
<b>BATTISCOPA</b> 6,5x120 2 1/8"x48"	Rectified Rettificato	120*	•	•	•	•
<b>BATTISCOPA</b> 7,5x60 3"x24"	Rectified Rettificato	106*	•	•	•	•

TH2.0 OUTDOOR SOLUTIONS available   
TH2.0 OUTDOORSOLUTIONS disponibile

\* Price code / pc. Codice prezzo / pz.



WALL Multicolor 60x120 . 24"x48" | White 120x280 48"x110"  
FURNITURE Patagonia 120x280 48"x110"  
FLOOR Multicolor 60x60 . 24"x24"

**V3**  
R10  
Rectified  
Rettificato  
Rektifiziert

**R11**  
Antislip  
Sabbiato  
Anti-dérapant  
Gesandet

**Porcelain stoneware coloured in body**  
Gres porcellanato colorato in massa  
Grès cérame coloré dans la masse  
Eingefärbtes Feinsteinzeug

## Mosaics.

Mosaici. Mosaïques. Mosaik.



White  
MOSAICO 36PZ  
30x30 12"x12"  
NAT

Price code / pc  
Codice prezzo / pz  
**110**



White  
MOSAICO ESAGONI  
26x30 10"x12"  
NAT

Price code / pc  
Codice prezzo / pz  
**122**



Grey  
MOSAICO 36PZ  
30x30 12"x12"  
NAT

Price code / pc  
Codice prezzo / pz  
**110**



Grey  
MOSAICO ESAGONI  
26x30 10"x12"  
NAT

Price code / pc  
Codice prezzo / pz  
**122**



Multicolor  
MOSAICO 36PZ  
30x30 12"x12"  
NAT

Price code / pc  
Codice prezzo / pz  
**110**



Multicolor  
MOSAICO ESAGONI  
26x30 10"x12"  
NAT

Price code / pc  
Codice prezzo / pz  
**122**

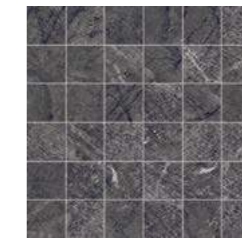

Anthracite  
MOSAICO 36PZ  
30x30 12"x12"  
NAT

Price code / pc  
Codice prezzo / pz  
**110**

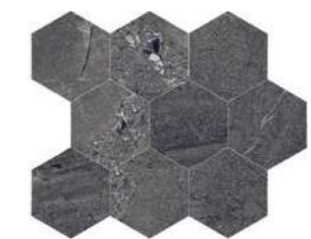

Anthracite  
MOSAICO ESAGONI  
26x30 10"x12"  
NAT

Price code / pc  
Codice prezzo / pz  
**122**



General  
index

Product  
indexes

The  
Company

## Collections

Marble Look  
Concrete Look  
Stone Look  
Metal Look  
Wood Look  
Cotto Look



TH2.0  
Outdoor  
Solutions

Bathroom  
furniture

Ventilated  
facades

Technical  
information

# Agathòs

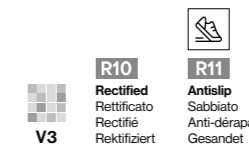

**Porcelain stoneware coloured in body**  
Gres porcellanato colorato in massa  
Grès cérame coloré dans la masse  
Eingefärbtes Feinsteinzeug

## Pattern variation.

Sviluppo grafico. Développement graphique par format. Farbverlauf.

### White



60x120 24"x48"

### Grey



60x120 24"x48"

### Multicolor



60x120 24"x48"

### Anthracite



60x120 24"x48"



FLOOR White 60x120 . 24"x48" | White 60x120 . 24"x48" TH2.0

## Collections

- Marble Look
- Concrete Look
- Stone Look**
- Metal Look
- Wood Look
- Cotto Look



# Cardosia

Delicate presence



WALL Anthracite 60x120 . 24"x48"  
FLOOR Anthracite 60x120 . 24"x48"



White



Beige



Grey



Anthracite

General index

Product indexes

The Company

### Collections

- Marble Look
- Concrete Look
- Stone Look
- Metal Look
- Wood Look
- Cotto Look



TH2.0  
Outdoor  
Solutions

Bathroom  
furniture

Ventilated  
facades

Technical  
information



Size Formato	Finishes Finiture	Price code sqm Codice prezzo m <sup>2</sup>	White	Beige	Grey	Anthracite
<b>120x120</b> 48"x48" →9 mm	Rectified Rettificato	155	•	•	•	•
<b>60x120</b> 24"x48" →9 mm	Rectified Rettificato	146	•	•	•	•
<b>60x60</b> 24"x24" →9 mm	Rectified Rettificato	141	•	•	•	•
<b>30x60</b> 12"x24" →9 mm	Rectified Rettificato	139	•	•	•	•
<b>BATTISCOPA</b> <b>6,5x120</b> 2 9/16"x48"	Rectified Rettificato	120*	•	•	•	•
<b>BATTISCOPA</b> <b>7,5x60</b> 3"x24"	Rectified Rettificato	106*	•	•	•	•

\* Price code / pc. Codice prezzo / pz.

## Mosaics.

Mosaici. Mosaïques. Mosaik.

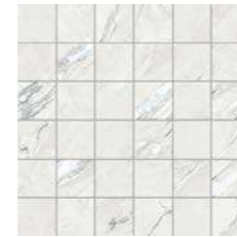

White  
MOSAICO 36PZ  
30x30 12"x12"  
NAT

Price code / pc  
Codice prezzo / pz  
**110**



White  
MOSAICO ESAGONI  
26x30 10"x12"  
NAT

Price code / pc  
Codice prezzo / pz  
**122**

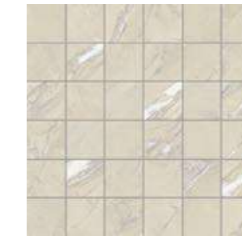

Beige  
MOSAICO 36PZ  
30x30 12"x12"  
NAT

Price code / pc  
Codice prezzo / pz  
**110**



Beige  
MOSAICO ESAGONI  
26x30 10"x12"  
NAT

Price code / pc  
Codice prezzo / pz  
**122**



Grey  
MOSAICO 36PZ  
30x30 12"x12"  
NAT

Price code / pc  
Codice prezzo / pz  
**110**



Grey  
MOSAICO ESAGONI  
26x30 10"x12"  
NAT

Price code / pc  
Codice prezzo / pz  
**122**

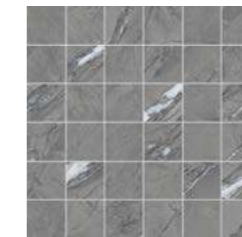

Anthracite  
MOSAICO 36PZ  
30x30 12"x12"  
NAT

Price code / pc  
Codice prezzo / pz  
**110**

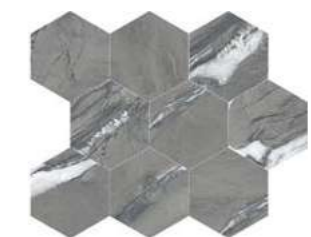

Anthracite  
MOSAICO ESAGONI  
26x30 10"x12"  
NAT

Price code / pc  
Codice prezzo / pz  
**122**



WALL Grey 60x120 . 24"x48" | Mood. Verve 120x280 . 48"x110"  
FURNITURE Grey 120x120 . 48"x48"  
FLOOR Grey 120x120 . 48"x48"

# Cardosia

### Pattern variation.

Sviluppo grafico. Développement graphique par format. Farbverlauf.

#### White



60x120 24"x48"

#### Beige



60x120 24"x48"

#### Grey



60x120 24"x48"

#### Anthracite

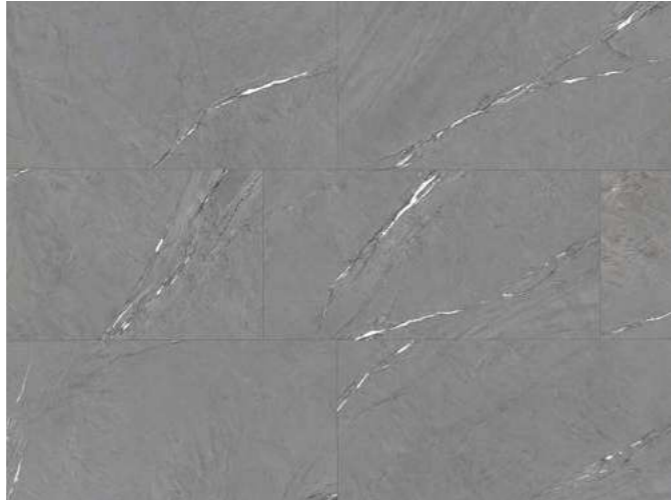

60x120 24"x48"

R10  
Rectified  
Rectificato  
Rectifié  
Rektifiziert  
V3

Porcelain stoneware coloured in body  
Gres porcellanato colorato in massa  
Grès cérame coloré dans la masse  
Eingefärbtes Feinsteinzeug



WALL White 60x120 . 24"x48"

Stone Look Cardosia

General index

Product indexes

The Company

### Collections

- Marble Look
- Concrete Look
- Stone Look
- Metal Look
- Wood Look
- Cotto Look



TH2.0  
Outdoor  
Solutions

Bathroom  
furniture

Ventilated  
facades

Technical  
information

# Ceppo di Grè

Italian essential



WALL White 120x280 . 48"x110"  
FLOOR Anthracite 120x120 . 48"x48"

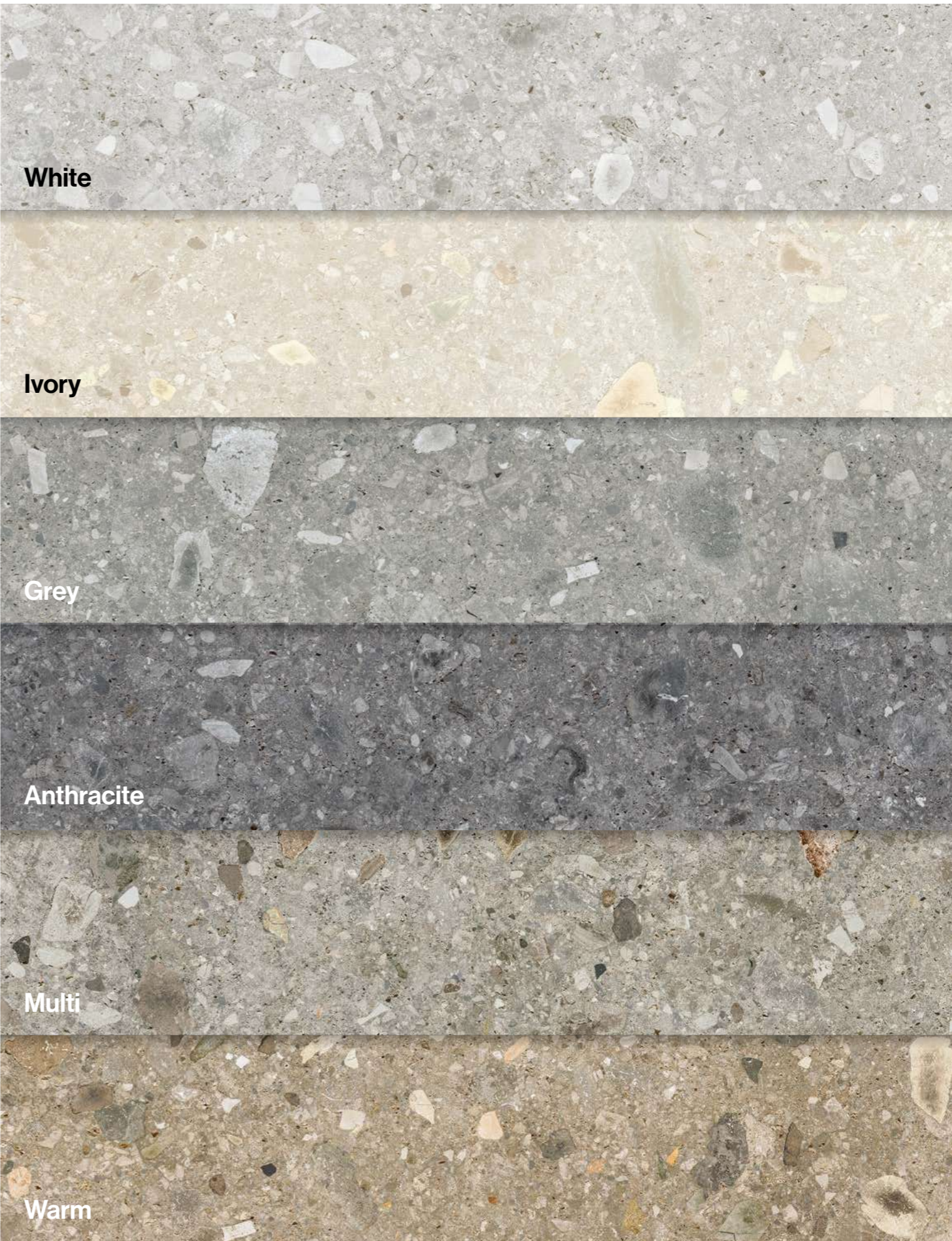

White

Ivory

Grey

Anthracite

Multi

Warm

General index

Product indexes

The Company

**Collections**  
Marble Look  
Concrete Look  
**Stone Look**  
Metal Look  
Wood Look  
Cotto Look



TH2.0  
Outdoor  
Solutions

Bathroom  
furniture

Ventilated  
facades

Technical  
information

# Ceppo di Grè



**R10**  
Rectified  
Rettificato  
Rektifiziert



**R11**  
Antislip  
Sabbiato  
Anti-dérapant  
Gesandet

**Porcelain stoneware coloured in body**  
Gres porcellanato colorato in massa  
Grès cérame coloré dans la masse  
Eingefärbtes Feinsteinzeug

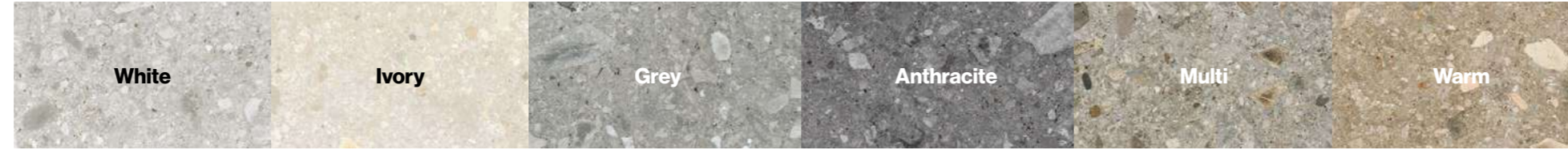

Size Formato	Finishes Finiture	Price code sqm Codice prezzo m <sup>2</sup>	White	Ivory	Grey	Anthracite	Multi	Warm
<b>EKTREME</b> <b>120x280</b> 48"x110" ±6 mm	Rectified Rettificato	159	•	•	•		•	
<b>120x120</b> 48"x48" ±9 mm	Rectified Rettificato	153	•	•	•	•	•	•
<b>60x120</b> 24"x48" ±9 mm	Rectified Rettificato	144	•	•	•	•	•	•
	Antislip Sabbiato	145	•	•	•	•	•	•
<b>80x80</b> 32"x32" ±9 mm	Rectified Rettificato	146	•	•	•	•	•	•
<b>60x60</b> 24"x24" ±9 mm	Rectified Rettificato	139	•	•	•	•	•	•
<b>30x60</b> 12"x24" ±9 mm	Rectified Rettificato	137	•	•	•	•	•	•
<b>BATTISCOPA</b> <b>6,5x120</b> 2 1/2"x48"	Rectified Rettificato	120*	•	•	•	•	•	•
<b>BATTISCOPA</b> <b>7,5x80</b> 3"x32"	Rectified Rettificato	109*	•	•	•	•	•	•
<b>BATTISCOPA</b> <b>7,5x60</b> 3"x24"	Rectified Rettificato	106*	•	•	•	•	•	•

TOP SOLUTION available\_see related catalog

TH2.0 OUTDOOR SOLUTIONS available

\* Price code / pc. Codice prezzo / pz.



# Fitch

Caress the space around you



WALL Cloud 30,8x61,5 12"x24"  
FLOOR Cloud 30,8x61,5 12"x24"



Cloud

Fawn

Gold

Rainbow

General index

Product indexes

The Company

### Collections

- Marble Look
- Concrete Look
- Stone Look
- Metal Look
- Wood Look
- Cotto Look



TH2.0  
Outdoor  
Solutions

Bathroom  
furniture

Ventilated  
facades

Technical  
information





Size Formato	Finishes Finiture	Price code sqm Codice prezzo m <sup>2</sup>	Cloud	Fawn	Gold	Rainbow
<b>30,8x61,5</b> 12"x24" ±9 mm	Natural Naturale	131	●	●	●	●
<b>BATTISCOPA</b> <b>7,5x61,5</b> 3"x24"	Natural Naturale	105*	●	●	●	●

\* Price code / pc. Codice prezzo / pz.

**Mosaics.**

Mosaici. Mosaïques. Mosaik.



Cloud  
MOSAICO 36PZ  
30x30 12"x12"  
NAT

Price code / pc  
Codice prezzo / pz  
**110**



Fawn  
MOSAICO 36PZ  
30x30 12"x12"  
NAT

Price code / pc  
Codice prezzo / pz  
**110**



Gold  
MOSAICO 36PZ  
30x30 12"x12"  
NAT

Price code / pc  
Codice prezzo / pz  
**110**

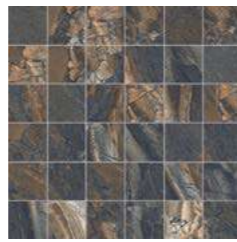

Rainbow  
MOSAICO 36PZ  
30x30 12"x12"  
NAT

Price code / pc  
Codice prezzo / pz  
**110**



WALL Rainbow Mosaico 36PZ 30x30 12"x12"

Stone Look Fitch

# Genesis

Everlasting mood



General index

Product indexes

The Company

**Collections**

- Marble Look
- Concrete Look
- Stone Look**
- Metal Look
- Wood Look
- Cotto Look



TH2.0 Outdoor Solutions

Bathroom furniture

Ventilated facades

Technical information



Size Formato	Finishes Finiture	Price code sqm Codice prezzo m <sup>2</sup>	Dove	Cocoa	Ash	Storm
<b>EKTREME</b> 120x280 48"x110" → 6 mm	Rectified Rettificato	159	•	•	•	•
<b>120x120</b> 48"x48" → 9 mm	Rectified Rettificato	153	•	•	•	•
<b>60x120</b> 24"x48" → 9 mm	Rectified Rettificato	144	•	•	•	•
<b>60x60</b> 24"x24" → 9 mm	Rectified Rettificato	139	•	•	•	•
	Antislip Sabbiato	140	•	•	•	•
<b>30x60</b> 12"x24" → 9 mm	Rectified Rettificato	137	•	•	•	•
	Antislip Sabbiato	138	•	•	•	•
<b>GROOVE</b> 60x120 24"x48" → 9 mm	Rectified Rettificato	151	•	•	•	•
<b>BATTISCOPA</b> 6,5x120 2 1/8"x48"	Rectified Rettificato	120*	•	•	•	•
<b>BATTISCOPA</b> 7,5x60 3"x24"	Rectified Rettificato	106*	•	•	•	•

TH2.0 OUTDOOR SOLUTIONS available   
TH2.0 OUTDOOR SOLUTIONS disponibile

\* Price code / pc. Codice prezzo / pz.



FLOOR Cocoa 60x120 . 24"x48"

Stone Look Genesis

General index

Product indexes

The Company

### Collections

- Marble Look
- Concrete Look
- Stone Look**
- Metal Look
- Wood Look
- Cotto Look



TH2.0  
Outdoor  
Solutions

Bathroom  
furniture

Ventilated  
facades

Technical  
information

# Genesis

**V3**  
**R10**  
 Rectificato  
 Rectifié  
 Rektifiziert

**R11**  
 Antislip  
 Sabbiato  
 Anti-dérapant  
 Gesandet

**Porcelain stoneware coloured in body**  
 Gres porcellanato colorato in massa  
 Grès cérame coloré dans la masse  
 Eingefärbtes Feinsteinzeug

General index

Product indexes

The Company

## Collections

- Marble Look
- Concrete Look
- Stone Look**
- Metal Look
- Wood Look
- Cotto Look



TH2.0  
 Outdoor  
 Solutions

Bathroom  
 furniture

Ventilated  
 facades

Technical  
 information

## Mosaics.

Mosaici. Mosaïques. Mosaik.



**Dove**  
 MOSAICO 36PZ  
 30x30 12"x12"  
 NAT  
 Price code / pc  
 Codice prezzo / pz  
**110**

**Dove**  
 MOSAICO MURETTO ANTICATO  
 30x30 12"x12"  
 NAT  
 Price code / pc  
 Codice prezzo / pz  
**115**

**Dove**  
 MOSAICO HERRINGBONE  
 33,5x33,5 13"x13"  
 NAT  
 Price code / pc  
 Codice prezzo / pz  
**121**



**Cocoa**  
 MOSAICO 36PZ  
 30x30 12"x12"  
 NAT  
 Price code / pc  
 Codice prezzo / pz  
**110**

**Cocoa**  
 MOSAICO MURETTO ANTICATO  
 30x30 12"x12"  
 NAT  
 Price code / pc  
 Codice prezzo / pz  
**115**

**Cocoa**  
 MOSAICO HERRINGBONE  
 33,5x33,5 13"x13"  
 NAT  
 Price code / pc  
 Codice prezzo / pz  
**121**



**Ash**  
 MOSAICO 36PZ  
 30x30 12"x12"  
 NAT  
 Price code / pc  
 Codice prezzo / pz  
**110**

**Ash**  
 MOSAICO MURETTO ANTICATO  
 30x30 12"x12"  
 NAT  
 Price code / pc  
 Codice prezzo / pz  
**115**

**Ash**  
 MOSAICO HERRINGBONE  
 33,5x33,5 13"x13"  
 NAT  
 Price code / pc  
 Codice prezzo / pz  
**121**



WALL **Cocoa** Groove 60x120 . 24"x48"



**Storm**  
 MOSAICO 36PZ  
 30x30 12"x12"  
 NAT  
 Price code / pc  
 Codice prezzo / pz  
**110**

**Storm**  
 MOSAICO MURETTO ANTICATO  
 30x30 12"x12"  
 NAT  
 Price code / pc  
 Codice prezzo / pz  
**115**

**Storm**  
 MOSAICO HERRINGBONE  
 33,5x33,5 13"x13"  
 NAT  
 Price code / pc  
 Codice prezzo / pz  
**121**

## 3D Groove texture.

Struttura 3D Groove. Structure 3D Groove. 3D Groove Textur.



**Dove**  
 GROOVE  
 60x120 24"x48"  
 ± 9 mm  
 RETT

**Cocoa**  
 GROOVE  
 60x120 24"x48"  
 ± 9 mm  
 RETT

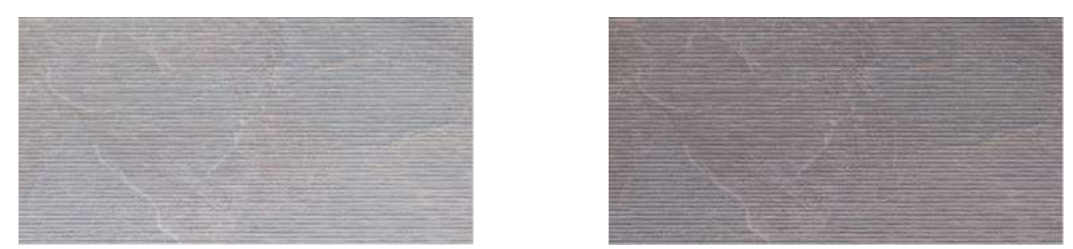

**Ash**  
 GROOVE  
 60x120 24"x48"  
 ± 9 mm  
 RETT

**Storm**  
 GROOVE  
 60x120 24"x48"  
 ± 9 mm  
 RETT

Stone Look Genesis

# Genesis

**Pattern variation.**

Sviluppo grafico. Développement graphique par format. Farbverlauf.

**Dove**



60x120 24"x48"

**Cocoa**



60x120 24"x48"

**Ash**



60x120 24"x48"

**Storm**



60x120 24"x48"

**V3**  
Rectificato  
Rectifié  
Rektifiziert

**R10**  
Rectificato  
Rectifié  
Rektifiziert

**R11**  
Antislip  
Sabbiato  
Anti-dérapant  
Gesandet

**Porcelain stoneware coloured in body**  
Gres porcellanato colorato in massa  
Grès cérame coloré dans la masse  
Eingefärbtes Feinsteinzeug



FLOOR Dove 30x60 . 12"x24"

Stone Look Genesis

General index

Product indexes

The Company

- Collections**
- Marble Look
  - Concrete Look
  - Stone Look**
  - Metal Look
  - Wood Look
  - Cotto Look



TH2.0  
Outdoor  
Solutions

Bathroom  
furniture

Ventilated  
facades

Technical  
information

# Heritage

Balancing aesthetics



FLOOR Cedar 120x120 - 48" x48"

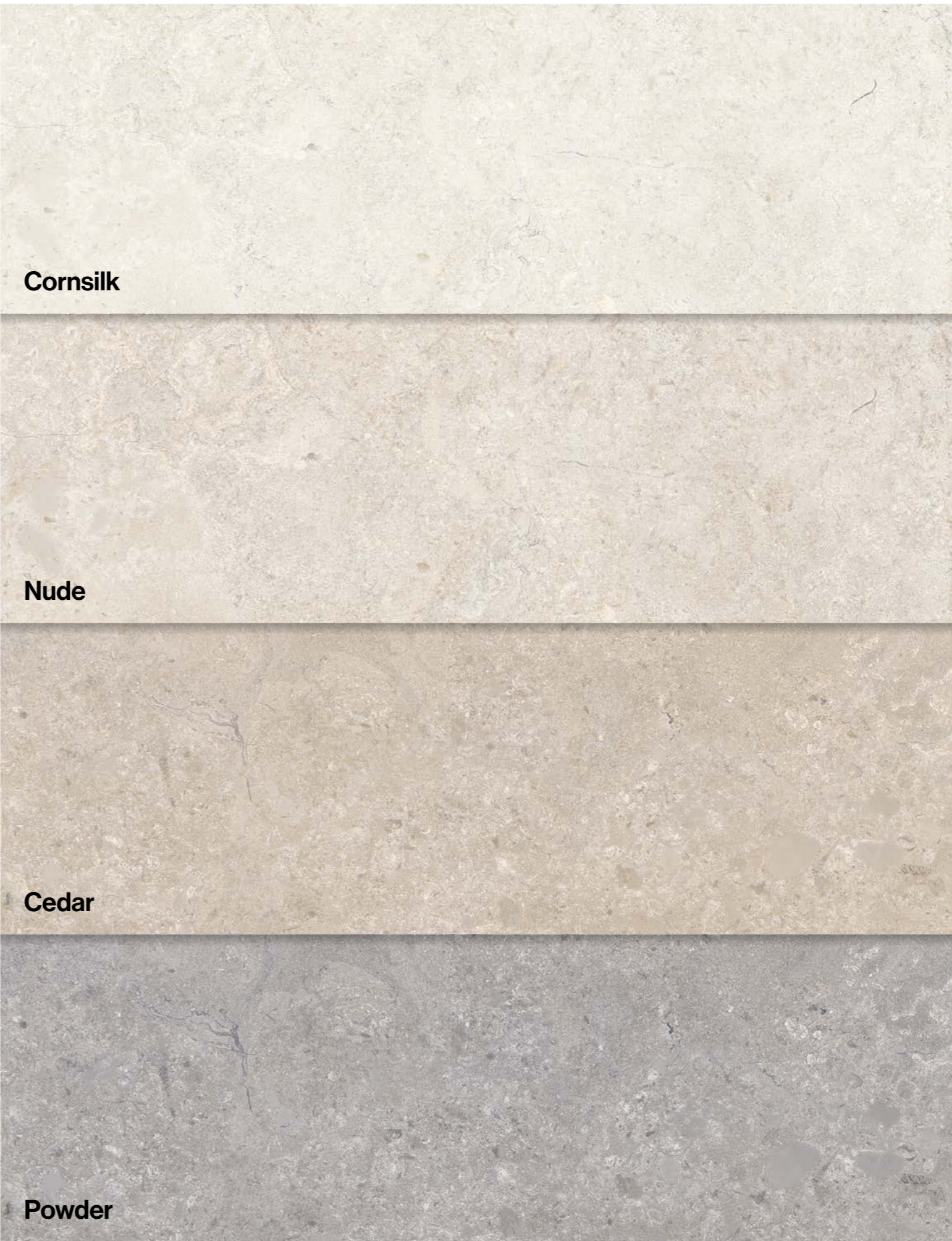

Cornsilk

Nude

Cedar

Powder



# Heritage



HiSense

HiReal



Honed  
Honed  
Seidenglänzend

R10  
Rectified  
Rettificato  
Rektifiziert



R11  
Antislip  
Sabbiato  
Anti-dérapant  
Gesandet

Porcelain stoneware coloured in body  
Grès porcellanato colorato in massa  
Grès cérame coloré dans la masse  
Eingefärbtes Feinsteinzeug



Size Formato	Finishes Finiture	Price code sqm Codice prezzo m <sup>2</sup>	Cornsilk	Nude	Cedar	Powder
	<b>EKTREME</b> 120x280 48"x110" ±6 mm	162	•	•	•	•
	Rectified Rettificato	155	•	•	•	•
	<b>120x120</b> 48"x48" ±9 mm	164	• HiReal	• HiReal	• HiReal	• HiReal
	Honed Honed	156	•	•	•	•
	Antislip Sabbiato	146	•	•	•	•
	<b>60x120</b> 24"x48" ±9 mm	158	• HiReal	• HiReal	• HiReal	• HiReal
	Rectified Rettificato	141	•	•	•	•
	<b>60x60</b> 24"x24" ±9 mm	143	•	•	•	•
	Rectified Rettificato	139	•	•	•	•
	<b>30x60</b> 12"x24" ±9 mm	139	•	•	•	•
	Rectified Rettificato	151	•	•	•	•
	<b>GROOVE</b> 60x120 24"x48" ±9 mm	151	•	•	•	•
	Rectified Rettificato	120*	•	•	•	•
	<b>BATTISCOPIA</b> 6,5x120 2 1/4"x48"	106*	•	•	•	•
	Rectified Rettificato	106*	•	•	•	•

TH2.0 OUTDOOR SOLUTIONS available   
TH2.0 OUTDOOR SOLUTIONS disponibile

\* Price code / pc. Codice prezzo / pz.



FLOOR Cornsilk 120x120 - 48"x48"

Stone Look Heritage

General index

Product indexes

The Company

## Collections

- Marble Look
- Concrete Look
- Stone Look
- Metal Look
- Wood Look
- Cotto Look



TH2.0  
Outdoor  
Solutions

Bathroom  
furniture

Ventilated  
facades

Technical  
information

# Heritage

**V3**  
Honed  
Honed  
Seidenglänzend

**R10**  
Rectificato  
Rettificato  
Rektifiziert

**R11**  
Antislip  
Sabbiato  
Anti-dérapant  
Gesandet

**Porcelain stoneware coloured in body**  
Grès porcellanato colorato in massa  
Grès cérame coloré dans la masse  
Eingefärbtes Feinsteinzeug

## Mosaics.

Mosaici. Mosaïques. Mosaik.



**Cornsilk**  
MOSAICO 36PZ  
30x30 12"x12"  
NAT

Price code / pc  
Codice prezzo / pz  
**110**

**Cornsilk**  
MOSAICO MURETTO ANTICATO  
26x30 10"x12"  
NAT

Price code / pc  
Codice prezzo / pz  
**115**

**Cornsilk**  
MOSAICO ESAGONI  
26x30 10"x12"  
NAT

Price code / pc  
Codice prezzo / pz  
**122**



**Nude**  
MOSAICO 36PZ  
30x30 12"x12"  
NAT

Price code / pc  
Codice prezzo / pz  
**110**

**Nude**  
MOSAICO MURETTO ANTICATO  
26x30 10"x12"  
NAT

Price code / pc  
Codice prezzo / pz  
**115**

**Nude**  
MOSAICO ESAGONI  
26x30 10"x12"  
NAT

Price code / pc  
Codice prezzo / pz  
**122**



**Cedar**  
MOSAICO 36PZ  
30x30 12"x12"  
NAT

Price code / pc  
Codice prezzo / pz  
**110**

**Cedar**  
MOSAICO MURETTO ANTICATO  
26x30 10"x12"  
NAT

Price code / pc  
Codice prezzo / pz  
**115**

**Cedar**  
MOSAICO ESAGONI  
26x30 10"x12"  
NAT

Price code / pc  
Codice prezzo / pz  
**122**

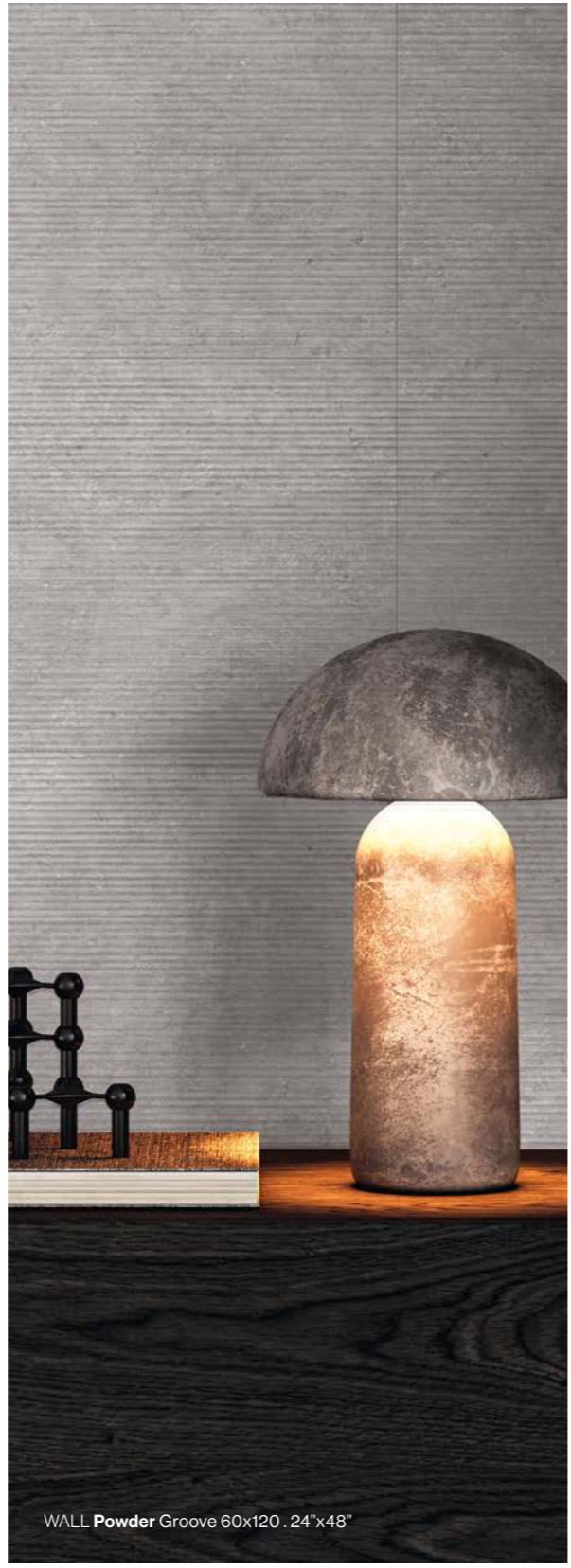

WALL Powder Groove 60x120 .24"x48"



**Powder**  
MOSAICO 36PZ  
30x30 12"x12"  
NAT

Price code / pc  
Codice prezzo / pz  
**110**

**Powder**  
MOSAICO MURETTO ANTICATO  
30x30 12"x12"  
NAT

Price code / pc  
Codice prezzo / pz  
**115**

**Powder**  
MOSAICO ESAGONI  
26x30 10"x12"  
NAT

Price code / pc  
Codice prezzo / pz  
**122**

## 3D Groove texture.

Struttura 3D Groove. Structure 3D Groove. 3D Groove Textur.



**Cornsilk**  
GROOVE  
60x120 24"x48"  
±9 mm  
RETT

**Nude**  
GROOVE  
60x120 24"x48"  
±9 mm  
RETT



**Cedar**  
GROOVE  
60x120 24"x48"  
±9 mm  
RETT

**Powder**  
GROOVE  
60x120 24"x48"  
±9 mm  
RETT



# Hollstone

Indulge in quietude



WALL Opal 60x120 . 24"x48"  
FLOOR Opal 60x120 . 24"x48"



Milky

Butter

Sour

Opal

Storm

Obsidian

General index

Product indexes

The Company

- Collections**
- Marble Look
  - Concrete Look
  - Stone Look**
  - Metal Look
  - Wood Look
  - Cotto Look



TH2.0  
Outdoor Solutions

Bathroom furniture

Ventilated facades

Technical information



Size Formato	Finishes Finiture	Price code sqm Codice prezzo m <sup>2</sup>	Milky	Butter	Sour	Opal	Storm	Obsidian
<b>120x120</b> 48"x48" →9 mm	Rectified Rettificato	153	•	•	•	•	•	•
<b>60x120</b> 24"x48" →9 mm	Rectified Rettificato	144	•	•	•	•	•	•
<b>80x80</b> 32"x32" →9 mm	Rectified Rettificato	146	•	•	•	•	•	•
	Antislip Sabbato	147	•	•	•	•	•	•
<b>60x60</b> 24"x24" →9 mm	Rectified Rettificato	139	•	•	•	•	•	•
<b>BATTISCOPIA</b> <b>6,5x120</b> 2 1/8"x48"	Rectified Rettificato	120 *	•	•	•	•	•	•
<b>BATTISCOPIA</b> <b>7,5x80</b> 3"x32"	Rectified Rettificato	109 *	•	•	•	•	•	•
<b>BATTISCOPIA</b> <b>7,5x60</b> 3"x24"	Rectified Rettificato	106 *	•	•	•	•	•	•

TH2.0 OUTDOOR SOLUTIONS available   
TH2.0 OUTDOOR SOLUTIONS disponibile

\* Price code / pc. Codice prezzo / pz.



WALL | FLOOR Sour 120x120 . 48"x48"

# Hollstone

**R10**  
Rectificato  
Rectifié  
Rektifiziert

**R11**  
Antislip  
Sabbiato  
Anti-dérapant  
Gesandet

**V2**

**Porcelain stoneware coloured in body**  
Gres porcellanato colorato in massa  
Grès cérame coloré dans la masse  
Eingefärbtes Feinsteinzeug

## Mosaics.

Mosaici. Mosaïques. Mosaik.

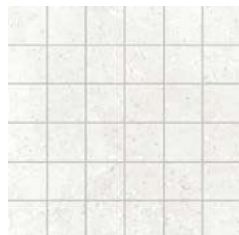

Milky  
MOSAICO 36PZ  
30x30 12"x12"  
NAT  
Price code / pc  
Codice prezzo / pz  
**110**



Milky  
MOSAICO MURETTO ANTICATO  
30x30 12"x12"  
NAT  
Price code / pc  
Codice prezzo / pz  
**115**



Butter  
MOSAICO 36PZ  
30x30 12"x12"  
NAT  
Price code / pc  
Codice prezzo / pz  
**110**



Butter  
MOSAICO MURETTO ANTICATO  
30x30 12"x12"  
NAT  
Price code / pc  
Codice prezzo / pz  
**115**



Sour  
MOSAICO 36PZ  
30x30 12"x12"  
NAT  
Price code / pc  
Codice prezzo / pz  
**110**



Sour  
MOSAICO MURETTO ANTICATO  
30x30 12"x12"  
NAT  
Price code / pc  
Codice prezzo / pz  
**115**



Opal  
MOSAICO 36PZ  
30x30 12"x12"  
NAT  
Price code / pc  
Codice prezzo / pz  
**110**



Opal  
MOSAICO MURETTO ANTICATO  
30x30 12"x12"  
NAT  
Price code / pc  
Codice prezzo / pz  
**115**



Storm  
MOSAICO 36PZ  
30x30 12"x12"  
NAT  
Price code / pc  
Codice prezzo / pz  
**110**



Storm  
MOSAICO MURETTO ANTICATO  
30x30 12"x12"  
NAT  
Price code / pc  
Codice prezzo / pz  
**115**



Obsidian  
MOSAICO 36PZ  
30x30 12"x12"  
NAT  
Price code / pc  
Codice prezzo / pz  
**110**

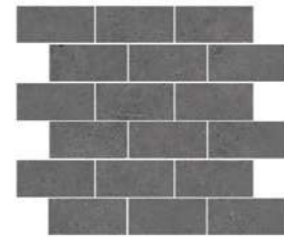

Obsidian  
MOSAICO MURETTO ANTICATO  
30x30 12"x12"  
NAT  
Price code / pc  
Codice prezzo / pz  
**115**



WALL **Butter** 120x120 . 48"x48"  
FLOOR **Butter** 120x120 . 48"x48"

Stone Look Hollstone

General index

Product indexes

The Company

**Collections**  
Marble Look  
Concrete Look  
**Stone Look**  
Metal Look  
Wood Look  
Cotto Look



TH2.0  
Outdoor Solutions

Bathroom furniture

Ventilated facades

Technical information

# Loop

Cloudy soft hues



WALL Ceppo di Grè. Multi 120x280 . 48"x110"  
FURNITURE Ceppo di Grè. Multi 163x324 . "64"x127" TOP SOLUTION  
FLOOR White 30,8x61,5 . 12"x24"



General index

Product indexes

The Company

## Collections

Marble Look  
Concrete Look  
**Stone Look**  
Metal Look  
Wood Look  
Cotto Look



TH2.0  
Outdoor  
Solutions

Bathroom  
furniture

Ventilated  
facades

Technical  
information

# Loop

V3 R10 R10 R11  
 Natural Rectified Antislip  
 Naturale Rettificato Sabbiato  
 Natur Rectifié Rektifiziert  
 Natur Gesandert

**Porcelain stoneware coloured in body**  
 Gres porcellanato colorato in massa  
 Grès cérame coloré dans la masse  
 Eingefärbtes Feinsteinzeug



Size Formato	Finishes Finiture	Price code sqm Codice prezzo m <sup>2</sup>	White	Beige	Grey	Anthracite
 <b>60x120</b> 24"x48" →9 mm	Rectified Rettificato	144	•	•	•	•
	Antislip Sabbiato	145	•	•	•	•
 <b>30,8x61,5</b> 12"x24" →9 mm	Natural Naturale	131	•	•	•	•
	Antislip Sabbiato	135	•	•	•	•
 BATTISCOPA <b>7,5x61,5</b> 3"x24"	Natural Naturale	105*	•	•	•	•
 ELEMENTO "L" INCOLLATO <b>30,8x61,5X5</b> 12"x24"x2"	Natural Naturale	126*	•	•	•	•
	Antislip Sabbiato	128*	•	•	•	•

TH2.0 OUTDOOR SOLUTIONS available   
 TH2.0 OUTDOOR SOLUTIONS disponibile

\* Price code / pc. Codice prezzo / pz.



FLOOR Beige 60x120 . 24" x48"

Stone Look Loop

General index

Product indexes

The Company

## Collections

- Marble Look
- Concrete Look
- Stone Look**
- Metal Look
- Wood Look
- Cotto Look



TH2.0  
Outdoor  
Solutions

Bathroom  
furniture

Ventilated  
facades

Technical  
information

# Loop

**Pattern variation.**

Sviluppo grafico. Développement graphique par format. Farbverlauf.

**White**



60x120 24"x48"

**Beige**



60x120 24"x48"

**Grey**



60x120 24"x48"

**Anthracite**



60x120 24"x48"

**Porcelain stoneware coloured in body**  
 Gres porcellanato colorato in massa  
 Grès cérame coloré dans la masse  
 Eingefärbtes Feinsteinzeug



WALL **White** 60x120 . 24"x48"  
 FLOOR **Anthracite** 30,8x61,5 . 12"x24"

Stone Look Loop

General index

Product indexes

The Company

- Collections**
- Marble Look
  - Concrete Look
  - Stone Look**
  - Metal Look
  - Wood Look
  - Cotto Look



TH2.0  
Outdoor  
Solutions

Bathroom  
furniture

Ventilated  
facades

Technical  
information

# Medley

Colour meets rhythm

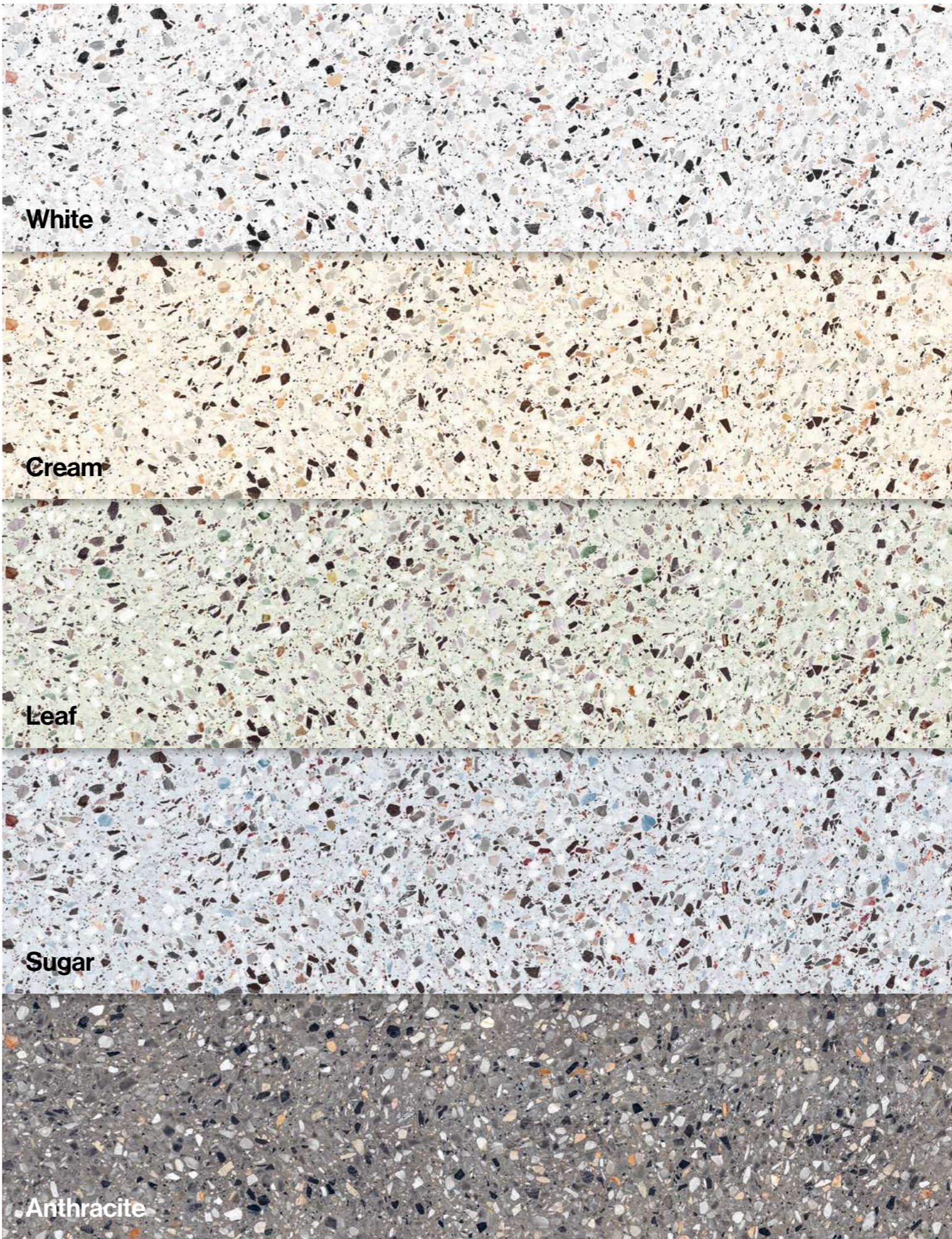

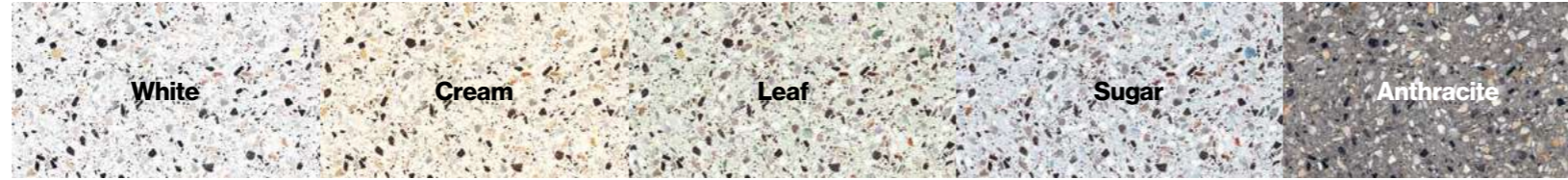

Size Formato	Finishes Finiture	Price code sqm Codice prezzo m <sup>2</sup>	White	Cream	Leaf	Sugar	Anthracite
<b>120x120</b> 48"x48" ⇒9 mm	Rectified Rettificato	<b>153</b>	•	•	•	•	•
<b>60x120</b> 24"x48" ⇒9 mm	Rectified Rettificato	<b>144</b>	•	•	•	•	•
<b>60x60</b> 24"x24" ⇒9 mm	Rectified Rettificato	<b>139</b>	•	•	•	•	•
<b>BATTISCOPIA</b> <b>7,5x60</b> 3"x24"	Rectified Rettificato	<b>106*</b>	•	•	•	•	•

TH2.0 OUTDOOR SOLUTIONS available   
TH2.0 OUTDOOR SOLUTIONS disponibile

\* Price code / pc. Codice prezzo / pz.



WALL Cream 60x120 . 24" x48"

## Mosaics.

Mosaici. Mosaïques. Mosaik.

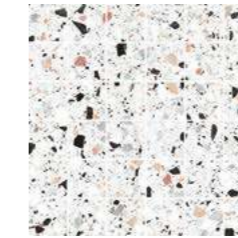

White  
MOSAICO 36PZ  
30x30 12"x12"  
NAT

Price code / pc  
Codice prezzo / pz  
**110**

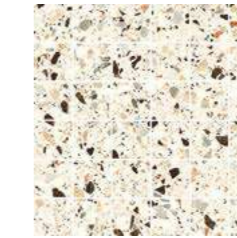

Cream  
MOSAICO 36PZ  
30x30 12"x12"  
NAT

Price code / pc  
Codice prezzo / pz  
**110**

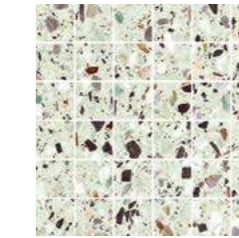

Leaf  
MOSAICO 36PZ  
30x30 12"x12"  
NAT

Price code / pc  
Codice prezzo / pz  
**110**

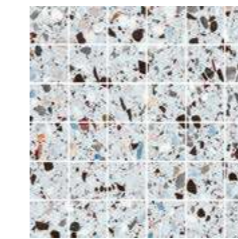

Sugar  
MOSAICO 36PZ  
30x30 12"x12"  
NAT

Price code / pc  
Codice prezzo / pz  
**110**

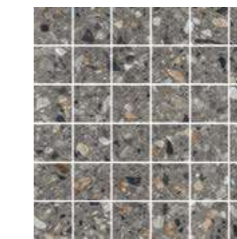

Anthracite  
MOSAICO 36PZ  
30x30 12"x12"  
NAT

Price code / pc  
Codice prezzo / pz  
**110**





# Nereidi

The embracing side of stone



WALL Ecrú 120x280 . 48"x110"  
FLOOR Ecrú 120x120 . 48"x48"



Almond

Cloud

Ecrú

Umber

General index

Product indexes

The Company

### Collections

- Marble Look
- Concrete Look
- Stone Look**
- Metal Look
- Wood Look
- Cotto Look



TH2.0 Outdoor Solutions

Bathroom furniture

Ventilated facades

Technical information



Size Formato	Finishes Finiture	Price code sqm Codice prezzo m <sup>2</sup>	Almond	Cloud	Ecrú	Umber
<b>EKTREME</b> 120x280 48"x110" →6mm	Rectified Rettificato	162	•	•	•	•
<b>120x120</b> 48"x48" →9mm	Rectified Rettificato	155	•	•	•	•
	Antislip Sabbato	156	•	•	•	•
<b>60x120</b> 24"x48" →9mm	Rectified Rettificato	146	•	•	•	•
	Rectified Rettificato	141	•	•	•	•
<b>60x60</b> 24"x24" →9mm	Rectified Rettificato	143	•	•	•	•
	Antislip Sabbato	143	•	•	•	•
<b>30x60</b> 12"x24" →9mm	Rectified Rettificato	139	•	•	•	•
	Rectified Rettificato	139	•	•	•	•
<b>GROOVE</b> 60x120 24"x48" →9mm	Rectified Rettificato	151	•	•	•	•
	Rectified Rettificato	151	•	•	•	•
<b>BATTISCOPA</b> 6,5x120 2 1/8"x48"	Rectified Rettificato	120*	•	•	•	•
	Rectified Rettificato	120*	•	•	•	•
<b>BATTISCOPA</b> 7,5x60 3"x24"	Rectified Rettificato	106*	•	•	•	•
	Rectified Rettificato	106*	•	•	•	•

TOP SOLUTION available [see related catalog](#)  TH2.0 OUTDOOR SOLUTIONS available   
 TOP SOLUTION disponibile [consulta il catalogo](#)  TH2.0 OUTDOOR SOLUTIONS disponibile  \* Price code / pc. Codice prezzo / pz.



WALL Ecrú 120x280 . 48"x110" | Ecrú Groove 60x120 . 24"x48" | Almond 30x60 . 12"x24"  
 FLOOR Almond 120x120 . 48"x48" | Robur. Cocoa 20x160 . 8"x63"



FLOOR Ecrú 120x120 . 48"x48"

## Mosaics.

Mosaici. Mosaïques. Mosaik.



Almond  
MOSAICO 36PZ  
30x30 12"x12"  
NAT

Price code / pc  
Codice prezzo / pz  
**110**



Almond  
MOSAICO ARROW  
30x30 12"x12"  
NAT

Price code / pc  
Codice prezzo / pz  
**121**



Almond  
MOSAICO MURETTO ANTICATO  
30x30 12"x12"  
NAT

Price code / pc  
Codice prezzo / pz  
**115**



Almond  
MOSAICO HERRINGBONE  
33,5x33,5 13"x13"  
NAT

Price code / pc  
Codice prezzo / pz  
**121**



Umber  
MOSAICO 36PZ  
30x30 12"x12"  
NAT

Price code / pc  
Codice prezzo / pz  
**110**



Umber  
MOSAICO ARROW  
30x30 12"x12"  
NAT

Price code / pc  
Codice prezzo / pz  
**121**



Umber  
MOSAICO MURETTO ANTICATO  
30x30 12"x12"  
NAT

Price code / pc  
Codice prezzo / pz  
**115**



Umber  
MOSAICO HERRINGBONE  
33,5x33,5 13"x13"  
NAT

Price code / pc  
Codice prezzo / pz  
**121**



Cloud  
MOSAICO 36PZ  
30x30 12"x12"  
NAT

Price code / pc  
Codice prezzo / pz  
**110**



Cloud  
MOSAICO ARROW  
30x30 12"x12"  
NAT

Price code / pc  
Codice prezzo / pz  
**121**



Cloud  
MOSAICO MURETTO ANTICATO  
30x30 12"x12"  
NAT

Price code / pc  
Codice prezzo / pz  
**115**



Cloud  
MOSAICO HERRINGBONE  
33,5x33,5 13"x13"  
NAT

Price code / pc  
Codice prezzo / pz  
**121**



## 3D Groove texture.

Struttura 3D Groove. Structure 3D Groove. 3D Groove Textur



Almond  
GROOVE  
60x120 24"x48"  
±9 mm  
RETT



Cloud  
GROOVE  
60x120 24"x48"  
±9 mm  
RETT



Ecrú  
GROOVE  
60x120 24"x48"  
±9 mm  
RETT



Umber  
GROOVE  
60x120 24"x48"  
±9 mm  
RETT

# Pennslate

Expect the unexpected



FLOOR Akiba 30x60 . 12"x24" | Akiba 60x120 . 24"x48" TH2.0



Forge

Pocono

Akiba

Bali

Koko

General index

Product indexes

The Company

### Collections

- Marble Look
- Concrete Look
- Stone Look**
- Metal Look
- Wood Look
- Cotto Look





TH2.0 Outdoor Solutions

Bathroom furniture

Ventilated facades





Technical information

# Pennslate

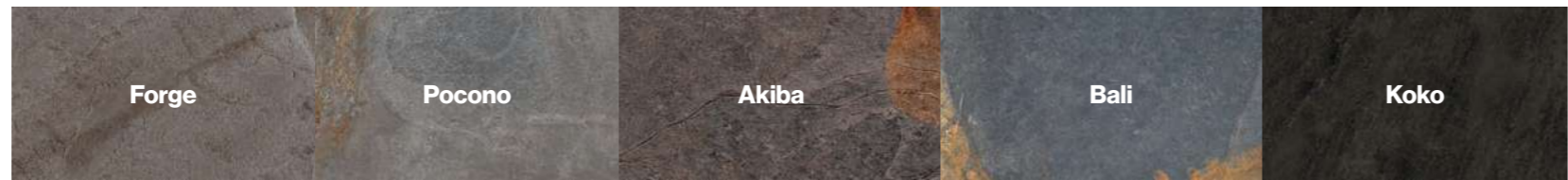
**Porcelain stoneware coloured in body**  
 Gres porcellanato colorato in massa  
 Grès cérame coloré dans la masse  
 Eingefärbtes Feinsteinzeug

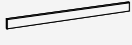

Size Formato	Finishes Finiture	Price code sqm Codice prezzo m <sup>2</sup>	Forge	Pocono	Akiba	Bali	Koko
 <b>60x120</b> 24"x48" ⇨9 mm	Rectified Rettificato	144	●	●	●	●	●
	Antislip Sabbliato	145	●	●	●	●	●
 <b>30x60</b> 12"x24" ⇨9 mm	Rectified Rettificato	137	●	●	●	●	●
	Rectified Rettificato	137	●	●	●	●	●
 <b>BATTISCOPA</b> <b>6,5x120</b> 2 9/16"x48"	Rectified Rettificato	120*	●	●	●	●	●
	Rectified Rettificato	120*	●	●	●	●	●
 <b>BATTISCOPA</b> <b>7,5x60</b> 3"x24"	Rectified Rettificato	106*	●	●	●	●	●
	Rectified Rettificato	106*	●	●	●	●	●

TH2.0 OUTDOOR SOLUTIONS available   
 TH2.0 OUTDOOR SOLUTIONS disponibile

\* Price code / pc. Codice prezzo / pz.



FLOOR Akiba 60x120 . 24"x48" TH2.0

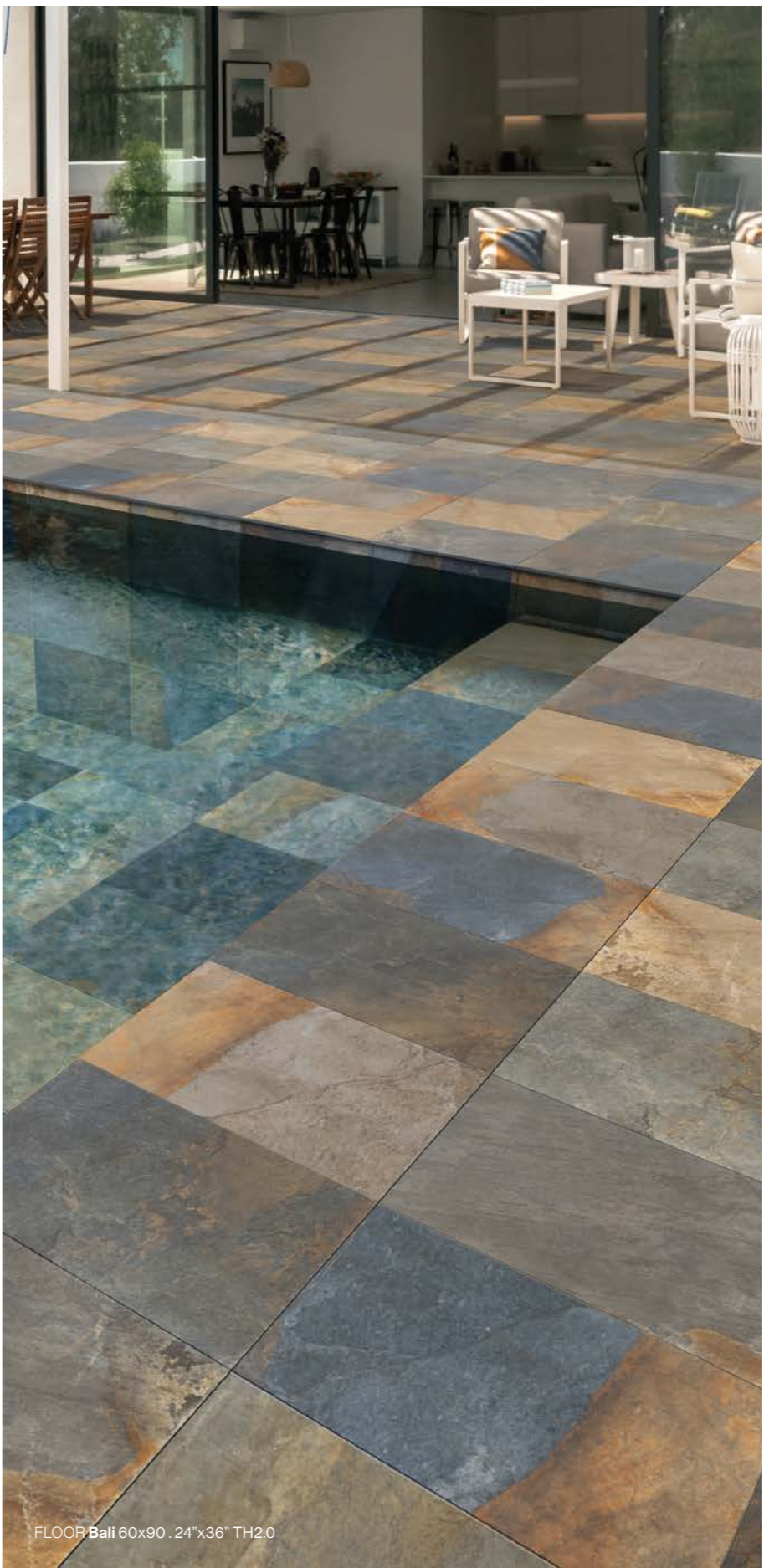

FLOOR Bali 60x90 . 24"x36" TH2.0

General index

Product indexes

The Company

Collections

- Marble Look
- Concrete Look
- Stone Look
- Metal Look
- Wood Look
- Cotto Look



TH2.0 Outdoor Solutions

Bathroom furniture

Ventilated facades

Technical information

**Pattern variation.**  
 Sviluppo grafico. Développement graphique par format. Farbverlauf.



60x120 24"x48"



60x120 24"x48"



60x120 24"x48"



60x120 24"x48"



60x120 24"x48"

- General index
- Product indexes
- The Company
- Collections**
  - Marble Look
  - Concrete Look
  - Stone Look**
  - Metal Look
  - Wood Look
  - Cotto Look
- TH2.0 Outdoor Solutions
- Bathroom furniture
- Ventilated facades
- Technical information

# Pietra di Vals

Compelling and captivating presence



WALL White 30,8x61,5 - 12"x24"  
FLOOR Grey 30,8x61,5 - 12"x24"



White

Grey

Stone Look Pietra di Vals

General index

Product indexes

The Company

### Collections

- Marble Look
- Concrete Look
- Stone Look**
- Metal Look
- Wood Look
- Cotto Look





TH2.0  
Outdoor  
Solutions

Bathroom  
furniture

Ventilated  
facades

Technical  
information

# Pietra di Vals









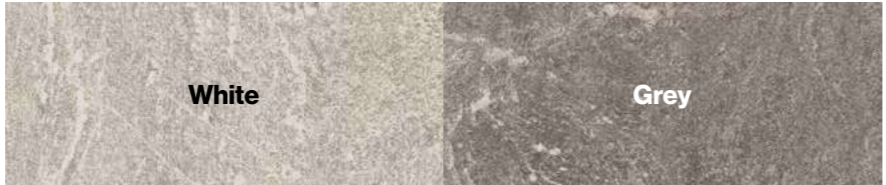









**Natural**  
 Naturale  
 Natur

**Structured outdoor**  
 Outdoor strutturato  
 Plein air structuré  
 Strukturierter Außenbereich

**Porcelain stoneware**  
 Gres porcellanato  
 Grès cérame coloré  
 Feinsteinzeug



Size Formato	Finishes Finiture	Price code sqm Codice prezzo m <sup>2</sup>		
 <b>30,8x61,5</b> 12"x24" ⇒ 9 mm	Natural Naturale	131	•	•
 <b>20x40</b> 8"x16" ⇒ 8,2 mm	Structured outdoor Outdoor strutturato	134		•
 <b>15x30</b> 6"x12" ⇒ 8,2 mm	Natural Naturale	124		•
 <b>BATTISCOPIA</b> <b>7,5x61,5</b> 3"x24"	Natural Naturale	105 *		•
 <b>BATTISCOPIA</b> <b>7,5x30</b> 3"x12"	Natural Naturale	101 *		•
 <b>ELEMENTO "L"</b> <b>INCOLLATO</b> <b>30,8x61,5x5</b> 12"x24"x2"	Natural Naturale	126 *		•
 <b>ELEMENTO "L"</b> <b>INCOLLATO</b> <b>15x30x5</b> 6"x12"x2"	Natural Naturale	108 *		•
 <b>ELEMENTO "L"</b> <b>MONOLITICO</b> <b>15x30x3,5</b> 6"x12"x1"	Natural Naturale	119 *		•
 <b>ELEMENTO "L"</b> <b>MONOLITICO</b> <b>10x40x4</b> 4"x16"x2"	Structured outdoor Outdoor strutturato	123 *		•

TH2.0 OUTDOOR SOLUTIONS available  \* Price code / pc. Codice prezzo / pz.  
 TH2.0 OUTDOOR SOLUTIONS disponibile

**Pattern variation.**  
 Sviluppo grafico. Développement graphique par format. Farbverlauf.



FLOOR White 30,8x61,5 . 12"x24"

General index

Product indexes

The Company

**Collections**  
 Marble Look  
 Concrete Look  
**Stone Look**  
 Metal Look  
 Wood Look  
 Cotto Look



**TH2.0**  
 Outdoor  
 Solutions

Bathroom furniture

Ventilated facades

Technical information



# Quarzi

Grounded in simplicity



FLOOR Gold 15x30 .6"x12" | Sandy 15x30 .6"x12"



Gold

Red Brown

Sandy

Silver

General index

Product indexes

The Company

### Collections

- Marble Look
- Concrete Look
- Stone Look**
- Metal Look
- Wood Look
- Cotto Look



TH2.0  
Outdoor  
Solutions

Bathroom  
furniture

Ventilated  
facades

Technical  
information

# Quarzi



Size Formato	Finishes Finiture	Price code sqm Codice prezzo m <sup>2</sup>	Gold	Red Brown	Sandy	Silver
□ 15x30 6"x12" ⇒ 8,2 mm	Natural Naturale	124	•	•	•	•
▭ BATTISCOPA 7,5x30 3"x12"	Natural Naturale	101*	•	•	•	•
▭ ELEMENTO "L" INCOLLATO 15x30x5 6"x12"x2"	Natural Naturale	108*	•	•	•	•
▭ ELEMENTO "L" MONOLITICO 15x30x3,5 6"x12"x1"	Natural Naturale	119*	•	•	•	•

\* Price code / pc. Codice prezzo / pz.

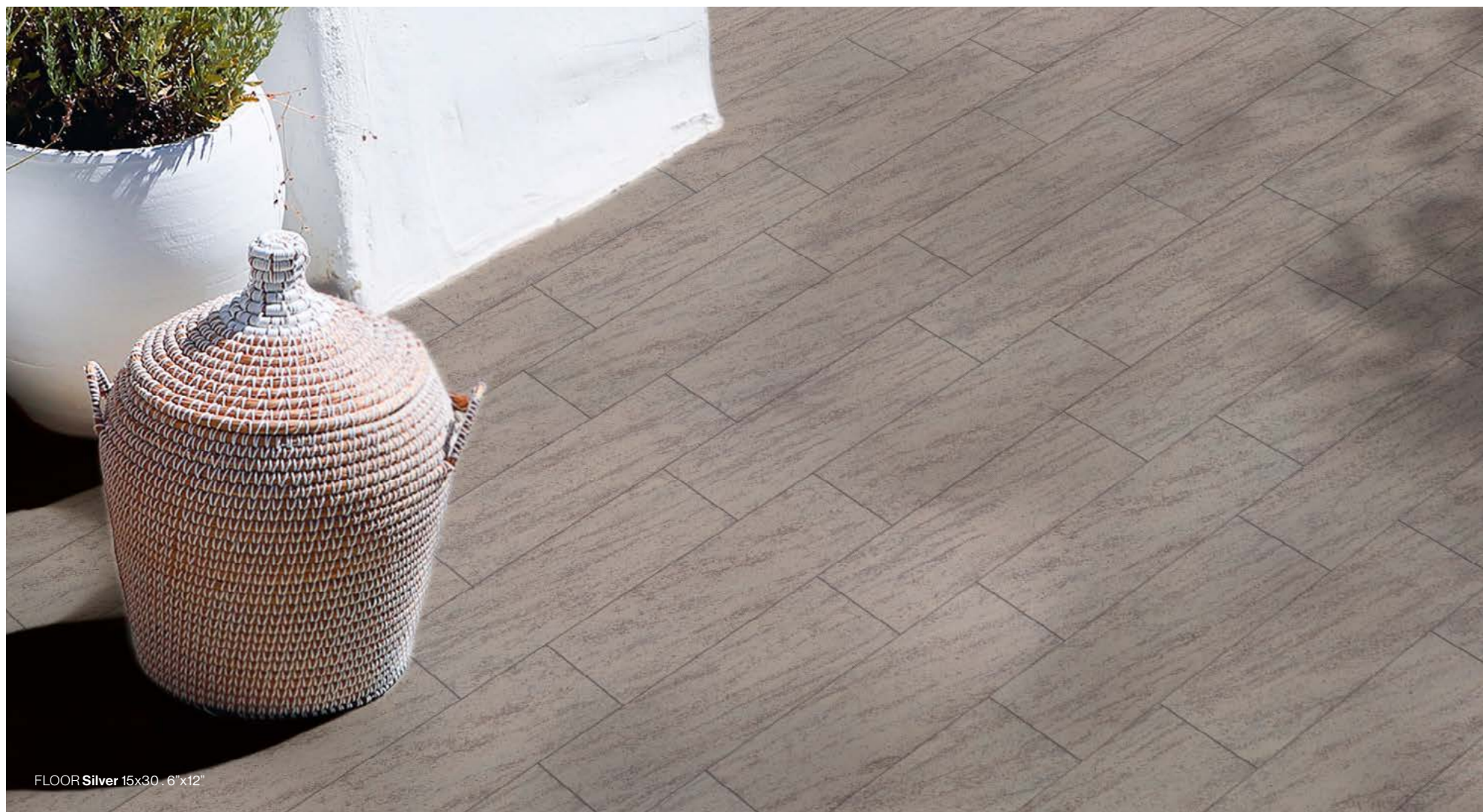

FLOOR Silver 15x30 . 6"x12"

R10  
Natural  
Naturale  
Natur  
V1

Porcelain stoneware  
Gres porcellanato  
Grès cérame coloré  
Feinsteinzeug



FLOOR Silver 15x30 . 6"x12"

General  
index

Product  
indexes

The  
Company

### Collections

- Marble Look
- Concrete Look
- Stone Look
- Metal Look
- Wood Look
- Cotto Look



TH2.0  
Outdoor  
Solutions

Bathroom  
furniture

Ventilated  
facades

Technical  
information

# Rushmore

Soothing shades, pure calm



WALL Sand 60x120 . 24"x48"  
FLOOR Grey 60x120 . 24"x48"

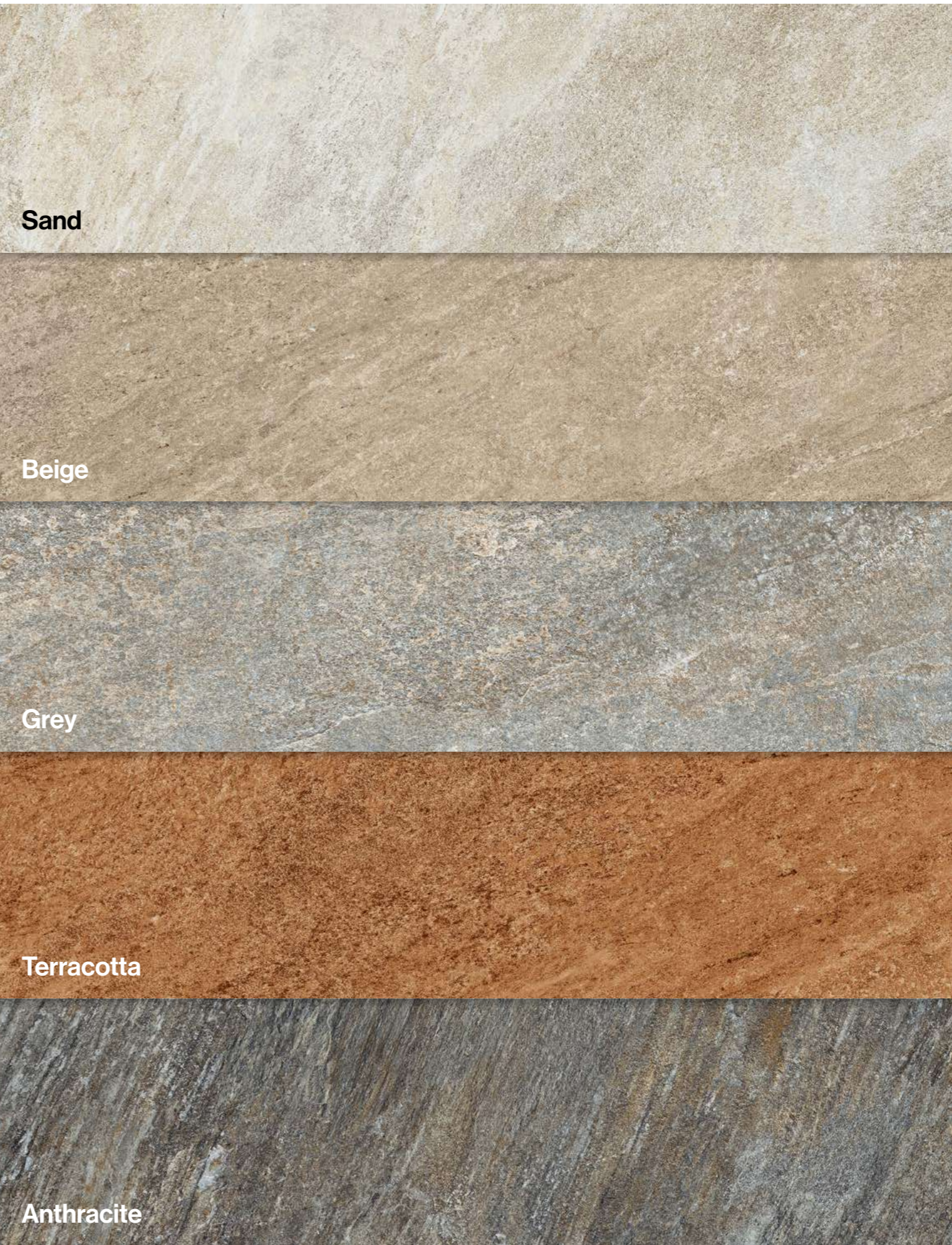

Sand

Beige

Grey

Terracotta

Anthracite

General index

Product indexes

The Company

- Collections**
- Marble Look
  - Concrete Look
  - Stone Look**
  - Metal Look
  - Wood Look
  - Cotto Look



TH2.0  
Outdoor  
Solutions

Bathroom  
furniture

Ventilated  
facades

Technical  
information

# Rushmore







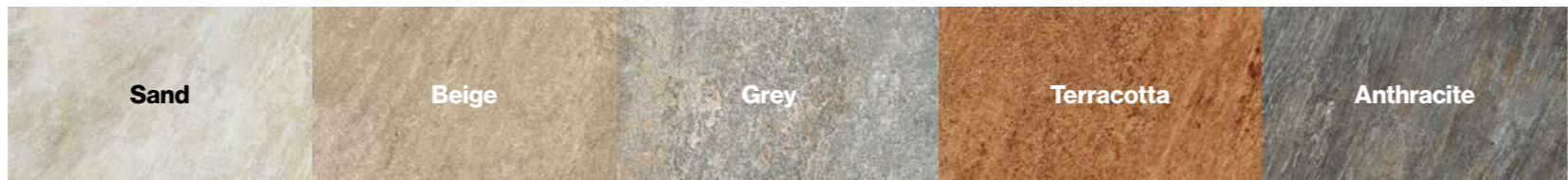

**R10**  
 Rectified  
 Rettificato  
 Rectifié  
 Rektifiziert

**R11**  
 Antislip  
 Sabbiato  
 Anti-dérapant  
 Gesandet

**R11**  
 Structured outdoor  
 Outdoor strutturato  
 Plein air structuré  
 Strukturierter Außenbereich

**Porcelain stoneware coloured in body**  
 Gres porcellanato colorato in massa  
 Grès cérame coloré dans la masse  
 Eingefärbtes Feinsteinzeug



Size Formato	Finishes Finiture	Price code sqm Codice prezzo m <sup>2</sup>	Sand	Beige	Grey	Terracotta	Anthracite
 <b>60x120</b> 24"x48" ⇒9 mm	Rectified Rettificato	144	•	•	•		•
	Antislip Sabbiato	145	•	•	•		•
 <b>60x60</b> 24"x24" ⇒9 mm	Rectified Rettificato	139	•	•	•		•
 <b>30x60</b> 12"x24" ⇒9 mm	Rectified Rettificato	137	•	•	•		•
 <b>20x40</b> 8"x16" ⇒8.2 mm	Structured outdoor Outdoor strutturato	134	•	•	•	•	
 BATTISCOPA <b>7,5x60</b> 3"x24"	Rectified Rettificato	106 * 	•	•	•		•
 ELEMENTO "L" MONOLITICO <b>10x40x4</b> 4"x16"x2	Structured outdoor Outdoor strutturato	123 * 	•	•	•	•	

TH2.0 OUTDOOR SOLUTIONS available   
 TH2.0 OUTDOOR SOLUTIONS disponibile

\* Price code / pc. Codice prezzo / pz.



WALL Sand 60x120 . 24"x48"

General index

Product indexes

The Company

Collections

- Marble Look
- Concrete Look
- Stone Look
- Metal Look
- Wood Look
- Cotto Look







TH2.0 Outdoor Solutions

Bathroom furniture

Ventilated facades

Technical information

# Rushmore

 **V2**  
 **R10**  
 Rectified  
 Rettificato  
 Rectifié  
 Rektifiziert  
 **R11**  
 Antislip  
 Sabbiato  
 Anti-dérapant  
 Gesandet  
 **R11**  
 Structured outdoor  
 Outdoor strutturato  
 Plein air structuré  
 Strukturierter Außenbereich

**Porcelain stoneware coloured in body**  
 Gres porcellanato colorato in massa  
 Grès cérame coloré dans la masse  
 Eingefärbtes Feinsteinzeug

## Mosaics.

Mosaici. Mosaïques. Mosaik.



Sand  
 MOSAICO 36PZ  
 30x30 12"x12"  
 NAT  
 Price code / pc  
 Codice prezzo / pz  
**110**  



Sand  
 MOSAICO ESAGONI  
 26x30 10"x12"  
 NAT  
 Price code / pc  
 Codice prezzo / pz  
**122**  



Beige  
 MOSAICO 36PZ  
 30x30 12"x12"  
 NAT  
 Price code / pc  
 Codice prezzo / pz  
**110**  



Beige  
 MOSAICO ESAGONI  
 26x30 10"x12"  
 NAT  
 Price code / pc  
 Codice prezzo / pz  
**122**  





Grey  
 MOSAICO 36PZ  
 30x30 12"x12"  
 NAT  
 Price code / pc  
 Codice prezzo / pz  
**110**  



Grey  
 MOSAICO ESAGONI  
 26x30 10"x12"  
 NAT  
 Price code / pc  
 Codice prezzo / pz  
**122**  





Anthracite  
 MOSAICO 36PZ  
 30x30 12"x12"  
 NAT  
 Price code / pc  
 Codice prezzo / pz  
**110**  



Anthracite  
 MOSAICO ESAGONI  
 26x30 10"x12"  
 NAT  
 Price code / pc  
 Codice prezzo / pz  
**122**  

## Pattern variation.

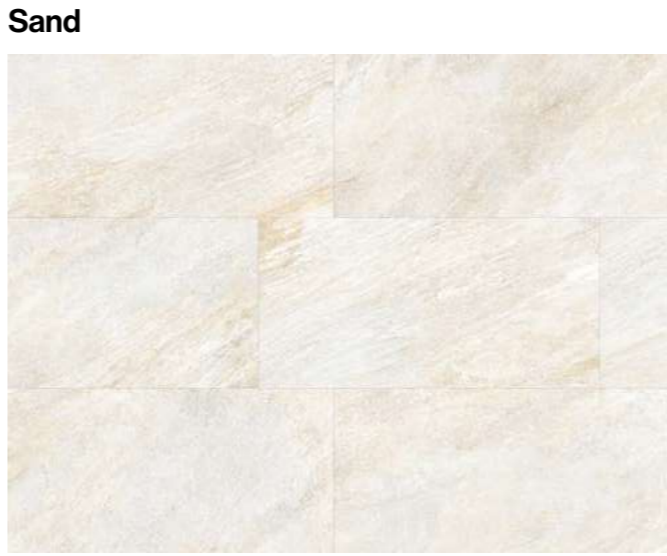
Sviluppo grafico. Développement graphique par format. Farbverlauf.



60x120 24"x48"



60x120 24"x48"



60x120 24"x48"



60x120 24"x48"

# Spark

Precious shades



WALL White 60x120 .24"x48"



Blue

White

Warm

Grey

General index

Product indexes

The Company

## Collections

Marble Look  
Concrete Look  
**Stone Look**  
Metal Look  
Wood Look  
Cotto Look



TH2.0  
Outdoor  
Solutions

Bathroom  
furniture

Ventilated  
facades

Technical  
information

# Spark

R10  
Rectified  
Rettificato  
Rectifié  
Rektifiziert  
V3

Porcelain stoneware coloured in body  
Gres porcellanato colorato in massa  
Grès cérame coloré dans la masse  
Eingefärbtes Feinsteinzeug



Size Formato	Finishes Finiture	Price code sqm Codice prezzo m <sup>2</sup>	Blue	White	Warm	Grey
<b>60x120</b> 24"x48" →9 mm	Rectified Rettificato	144	•	•	•	•
<b>60x60</b> 24"x24" →9 mm	Rectified Rettificato	139	•	•	•	•
<b>BATTISCOPIA</b> <b>6,5x120</b> 2 7/16"x48"	Rectified Rettificato	120*	•	•	•	•
<b>BATTISCOPIA</b> <b>7,5x60</b> 3"x24"	Rectified Rettificato	106*	•	•	•	•

TH2.0 OUTDOOR SOLUTIONS available  **TH2.0 OUTDOOR SOLUTIONS** disponibile  \* Price code / pc. Codice prezzo / pz.

## Mosaics. Mosaici. Mosaïques. Mosaik.

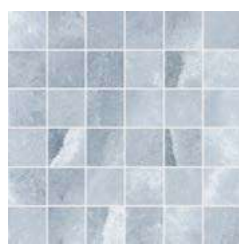

Blue  
MOSAICO 36PZ  
30x30 12"x12"  
NAT  
Price code / pc  
Codice prezzo / pz  
**110**



Blue  
MOSAICO ESAGONI  
26x30 10"x12"  
NAT  
Price code / pc  
Codice prezzo / pz  
**122**



White  
MOSAICO 36PZ  
30x30 12"x12"  
NAT  
Price code / pc  
Codice prezzo / pz  
**110**



White  
MOSAICO ESAGONI  
26x30 10"x12"  
NAT  
Price code / pc  
Codice prezzo / pz  
**122**



Warm  
MOSAICO 36PZ  
30x30 12"x12"  
NAT  
Price code / pc  
Codice prezzo / pz  
**110**



Warm  
MOSAICO ESAGONI  
26x30 10"x12"  
NAT  
Price code / pc  
Codice prezzo / pz  
**122**



Grey  
MOSAICO 36PZ  
30x30 12"x12"  
NAT  
Price code / pc  
Codice prezzo / pz  
**110**



Grey  
MOSAICO ESAGONI  
26x30 10"x12"  
NAT  
Price code / pc  
Codice prezzo / pz  
**122**



FURNITURE Patagonia 163x324 . 64"x127" TOP SOLUTION  
FLOOR Grey 60x120 . 24"x48"

Stone Look Spark

General index

Product indexes

The Company

- Collections**
- Marble Look
  - Concrete Look
  - Stone Look**
  - Metal Look
  - Wood Look
  - Cotto Look

TH2.0 Outdoor Solutions

Bathroom furniture

Ventilated facades

Technical information

# Spark

## Pattern variation.

Sviluppo grafico. Développement graphique par format. Farbverlauf.

### Blue



60x120 24"x48"

### White



60x120 24"x48"

### Warm



60x120 24"x48"

### Grey



60x120 24"x48"

R10  
Rectified  
Rettificato  
Rectifié  
Rektifiziert  
V3

Porcelain stoneware coloured in body  
Gres porcellanato colorato in massa  
Grès cérame coloré dans la masse  
Eingefärbtes Feinsteinzeug



FLOOR Grey 60x120 . 24"x48" TH2.0





# Sunstone

Essential naturality



WALL **Loki** 120x280 . 48"x110"  
FLOOR **Loki** 120x120 . 48"x48"



**Baugi**

**Freya**

**Alof**

**Loki**

**Groa**

**Norne**

General  
index

Product  
indexes

The  
Company

## Collections

Marble Look  
Concrete Look  
**Stone Look**  
Metal Look  
Wood Look  
Cotto Look







TH2.0  
Outdoor  
Solutions

Bathroom  
furniture

Ventilated  
facades











Technical  
information

# Sunstone

**V3**  
 **R10**  
 Natural  
 Naturale  
 Natur  
 **R10**  
 Rectified  
 Rettificato  
 Rectifié  
 Rektifiziert  
 **R11**  
 Antislip  
 Sabbiato  
 Anti-dérapant  
 Gesandet  
 **R11**  
 Structured outdoor  
 Outdoor strutturato  
 Plein air structuré  
 Strukturierter Außenbereich

**Porcelain stoneware coloured in body**  
 Gres porcellanato colorato in massa  
 Grès cérame coloré dans la masse  
 Eingefärbtes Feinsteinzeug



Size Formato	Finishes Finiture	Price code sqm Codice prezzo m <sup>2</sup>	Baugi	Freya	Alof	Loki	Groa	Norne
	<b>EKTREME</b> <b>120x280</b> 48"x110" ⇒ 6 mm	Rectified Rettificato	159	•	•	•	•	
	<b>120x120</b> 48"x48" ⇒ 9 mm	Rectified Rettificato	153	•	•	•	•	•
	<b>60x120</b> 24"x48" ⇒ 9 mm	Rectified Rettificato	144	•	•	•	•	•
		Antislip Sabbiato	145	•	•	•	•	•
	<b>60x60</b> 24"x24" ⇒ 9 mm	Rectified Rettificato	139	•	•	•	•	•
	<b>30,8x61,5</b> 12"x24" ⇒ 9 mm	Natural Naturale	131	•	•	•	•	•
	<b>30x60</b> 12"x24" ⇒ 9 mm	Rectified Rettificato	137	•	•	•	•	•
	<b>20x40</b> 8"x16" ⇒ 8,2 mm	Structured outdoor Outdoor strutturato	134	•	•	•	•	•
	<b>BATTISCOPA</b> <b>7,5x61,5</b> 3"x24"	Natural Naturale	105 *	•	•	•	•	•
	<b>BATTISCOPA</b> <b>7,5x60</b> 3"x24"	Rectified Rettificato	106 *	•	•	•	•	•
	<b>ELEMENTO "L"</b> <b>MONOLITICO</b> <b>10x40x4</b> 4"x16"x2"	Structured outdoor Outdoor strutturato	123 *	•	•	•	•	•

TH2.0 OUTDOOR SOLUTIONS available  \* Price code / pc. Codice prezzo / pz.  
 TH2.0 OUTDOOR SOLUTIONS disponibile

General index

Product indexes

The Company

**Collections**  
 Marble Look  
 Concrete Look  
**Stone Look**  
 Metal Look  
 Wood Look  
 Cotto Look

TH2.0 Outdoor Solutions

Bathroom furniture

Ventilated facades

Technical information

# Sunstone

## Mosaics.

Mosaici. Mosaïques. Mosaik.



Baugi  
MOSAICO 36PZ  
30x30 12"x12"  
NAT

Price code / pc  
Codice prezzo / pz  
**110**



Freya  
MOSAICO 36PZ  
30x30 12"x12"  
NAT

Price code / pc  
Codice prezzo / pz  
**110**



Alof  
MOSAICO 36PZ  
30x30 12"x12"  
NAT

Price code / pc  
Codice prezzo / pz  
**110**



Loki  
MOSAICO 36PZ  
30x30 12"x12"  
NAT

Price code / pc  
Codice prezzo / pz  
**110**



Groa  
MOSAICO 36PZ  
30x30 12"x12"  
NAT

Price code / pc  
Codice prezzo / pz  
**110**



Norne  
MOSAICO 36PZ  
30x30 12"x12"  
NAT

Price code / pc  
Codice prezzo / pz  
**110**



WALL Baugi 120x280 . 48"x110"  
FLOOR Freya 120x120 . 48"x48"

**V3**  
**R10**  
Natural  
Naturale  
Natur  
**R10**  
Rectified  
Rettificato  
Rectifié  
Rektifiziert  
**R11**  
Antislip  
Sabbiato  
Anti-dérapant  
Gesandet  
**R11**  
Structured outdoor  
Outdoor strutturato  
Plein air structuré  
Strukturierter Außenbereich

**Porcelain stoneware coloured in body**  
Gres porcellanato colorato in massa  
Grès cérame coloré dans la masse  
Eingefärbtes Feinsteinzeug

General index

Product indexes

The Company

**Collections**  
Marble Look  
Concrete Look  
**Stone Look**  
Metal Look  
Wood Look  
Cotto Look



TH2.0  
Outdoor  
Solutions

Bathroom  
furniture

Ventilated  
facades

Technical  
information

## Pattern variation.

Sviluppo grafico. Développement graphique par format. Farbverlauf.

### Baugi



60x120 24"x48"

### Freya



60x120 24"x48"

### Alof



60x120 24"x48"

# Sunstone

**Pattern variation.**

Sviluppo grafico. Développement graphique par format. Farbverlauf.

**Loki**



60x120 24"x48"

**Groa**

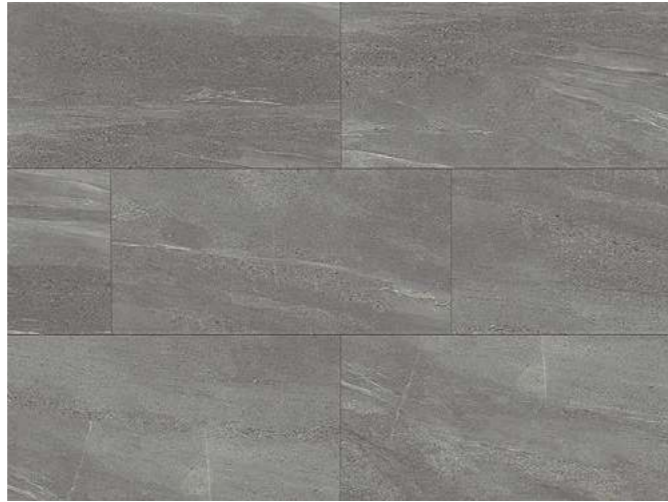

60x120 24"x48"

**Norne**



60x120 24"x48"

**V3**  
**R10** Natural Naturale Natur  
**R10** Rectified Rettificato Rettifié Rektifiziert  
**R11** Antislip Sabbiato Anti-dérapant Gesandnet  
**R11** Structured outdoor Outdoor strutturato Plein air structuré Strukturierter Außenbereich

**Porcelain stoneware coloured in body**  
 Gres porcellanato colorato in massa  
 Grès cérame coloré dans la masse  
 Eingefärbtes Feinsteinzeug



FLOOR Freya 120x120 . 48"x48" TH2.0

Stone Look Sunstone

General index

Product indexes

The Company

- Collections**
- Marble Look
  - Concrete Look
  - Stone Look**
  - Metal Look
  - Wood Look
  - Cotto Look



TH2.0 Outdoor Solutions

Bathroom furniture

Ventilated facades

Technical information

# Urano

Powerful emotion



FLOOR Grigio 30,8x61,5 - 12"x24" | Beige 15x30 - 6"x12"



Bianco

Panna

Beige

Grigio

Nero

General index

Product indexes

The Company

**Collections**  
 Marble Look  
 Concrete Look  
**Stone Look**  
 Metal Look  
 Wood Look  
 Cotto Look



TH2.0 Outdoor Solutions

Bathroom furniture

Ventilated facades

Technical information

# Urano

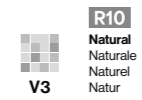

**Porcelain stoneware**  
Gres porcellanato  
Grès cérame coloré  
Feinsteinzeug

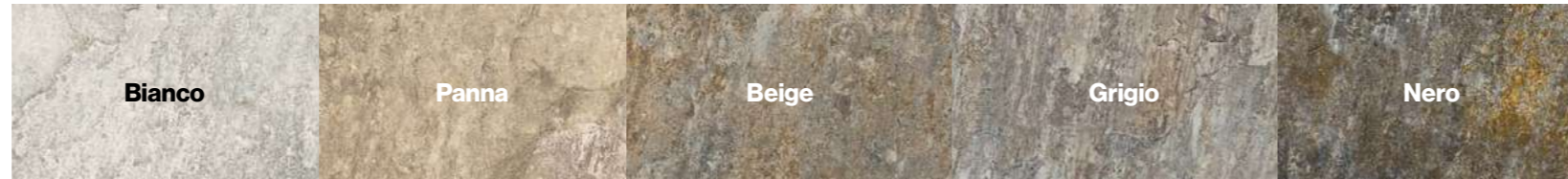

Size Formato	Finishes Finiture	Price code sqm Codice prezzo m <sup>2</sup>	Bianco	Panna	Beige	Grigio	Nero
<b>30,8x61,5</b> 12"x24" ±9 mm	Natural Naturale	131	•	•	•	•	•
<b>15x30</b> 6"x12" ±8,2 mm	Natural Naturale	124		•	•	•	
<b>BATTISCOPA</b> <b>7,5x61,5</b> 3"x24"	Natural Naturale	105*	•	•	•	•	•
<b>BATTISCOPA</b> <b>7,5x30</b> 3"x12"	Natural Naturale	101*		•	•	•	
<b>ELEMENTO "L"</b> <b>INCOLLATO</b> <b>30,8x61,5x5</b> 12"x24"x2"	Natural Naturale	126*	•	•	•	•	•
<b>ELEMENTO "L"</b> <b>INCOLLATO</b> <b>15x30x5</b> 6"x12"x2"	Natural Naturale	108*		•	•	•	

TH2.0 OUTDOOR SOLUTIONS available   
TH2.0 OUTDOOR SOLUTIONS disponibile

\* Price code / pc. Codice prezzo / pz.



FLOOR Grigio 60x60 - 24"x24" TH2.0

## Mosaics.

Mosaici. Mosaïques. Mosaik.



Bianco  
MOSAICO 36PZ  
30x30 12"x12"  
NAT

Price code / pc  
Codice prezzo / pz  
**110**



Panna  
MOSAICO 36PZ  
30x30 12"x12"  
NAT

Price code / pc  
Codice prezzo / pz  
**110**



Beige  
MOSAICO 36PZ  
30x30 12"x12"  
NAT

Price code / pc  
Codice prezzo / pz  
**110**



Grigio  
MOSAICO 36PZ  
30x30 12"x12"  
NAT

Price code / pc  
Codice prezzo / pz  
**110**



Nero  
MOSAICO 36PZ  
30x30 12"x12"  
NAT

Price code / pc  
Codice prezzo / pz  
**110**



General  
index

Product  
indexes

The  
Company

## Collections

Marble Look  
Concrete Look  
**Stone Look**  
Metal Look  
Wood Look  
Cotto Look



TH2.0  
Outdoor  
Solutions

Bathroom  
furniture

Ventilated  
facades

Technical  
information

# Utah

Stone variations



FLOOR Desert 30,8x61,5 12"x24"

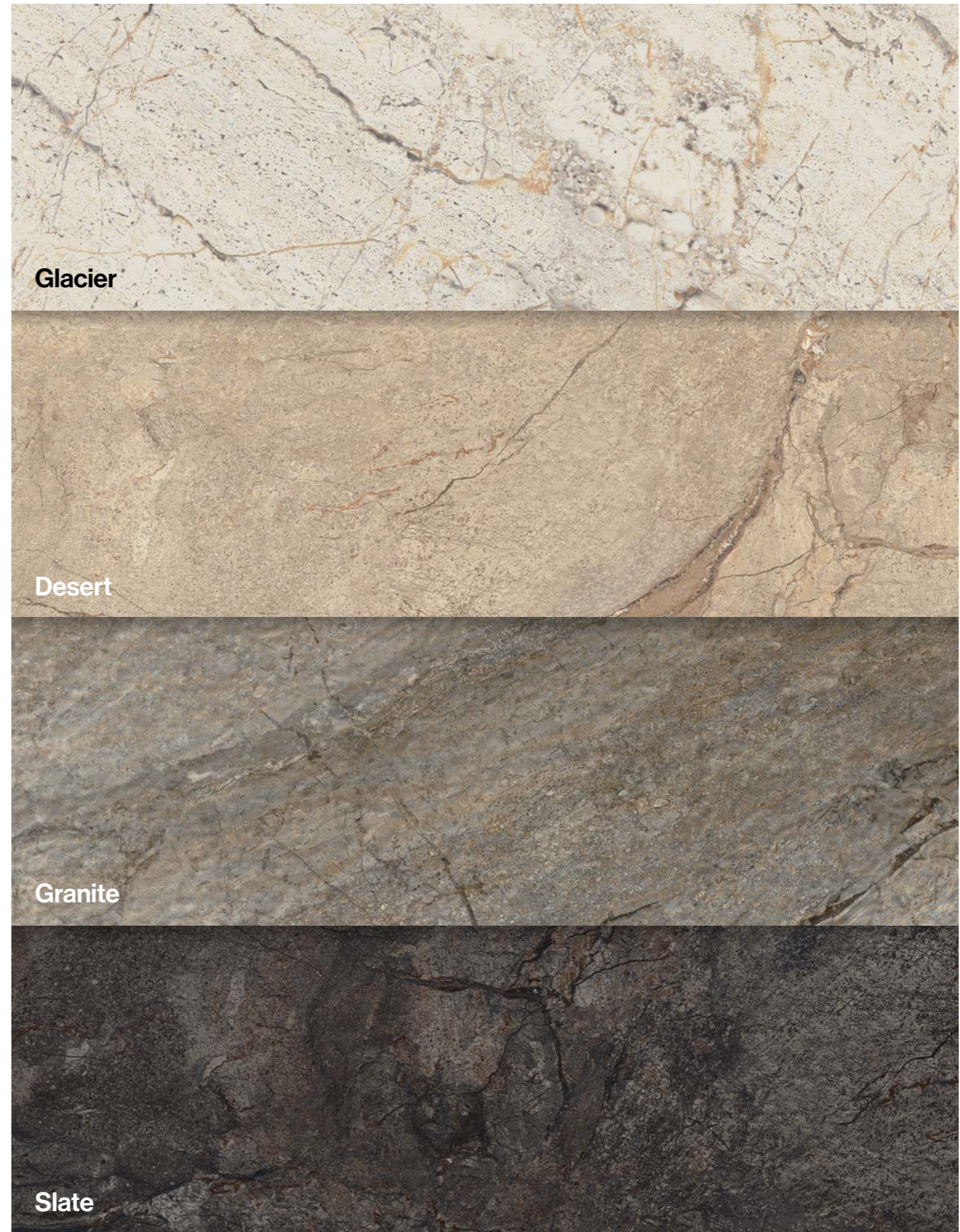

Glacier

Desert

Granite

Slate

General index

Product indexes

The Company

### Collections

- Marble Look
- Concrete Look
- Stone Look**
- Metal Look
- Wood Look
- Cotto Look



TH2.0  
Outdoor  
Solutions

Bathroom  
furniture

Ventilated  
facades

Technical  
information

# Utah

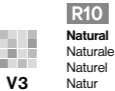

Porcelain stoneware coloured in body  
Gres porcellanato colorato in massa  
Grès cérame coloré dans la masse  
Eingefärbtes Feinsteinzeug



Size Formato	Finishes Finiture	Price code sqm Codice prezzo m <sup>2</sup>				
<b>30,8x61,5</b> 12"x24" ±9 mm	Natural Naturale	131	•	•	•	•
<b>BATTISCOPA</b> <b>7,5x61,5</b> 3"x24"	Natural Naturale	105*	•	•	•	•

\* Price code / pc. Codice prezzo / pz.

## Mosaics. Mosaici. Mosaïques. Mosaik.



Glacier  
MOSAICO 36PZ  
30x30 12"x12"  
NAT

Price code / pc  
Codice prezzo / pz  
**110**



Desert  
MOSAICO 36PZ  
30x30 12"x12"  
NAT

Price code / pc  
Codice prezzo / pz  
**110**



Granite  
MOSAICO 36PZ  
30x30 12"x12"  
NAT

Price code / pc  
Codice prezzo / pz  
**110**



Slate  
MOSAICO 36PZ  
30x30 12"x12"  
NAT

Price code / pc  
Codice prezzo / pz  
**110**



WALL **Slate** 30,8x61,5 . 12"x24"  
FLOOR **Granite** 30,8x61,5 . 12"x24"

Stone Look Utah

General index

Product indexes

The Company

Collections  
Marble Look  
Concrete Look  
**Stone Look**  
Metal Look  
Wood Look  
Cotto Look



TH2.0  
Outdoor Solutions

Bathroom furniture

Ventilated facades

Technical information



# Wonder

Comfortably warm



WALL **Dunes** 120x280 . 48"x110"  
FLOOR **Dunes** 120x120 . 48"x48"

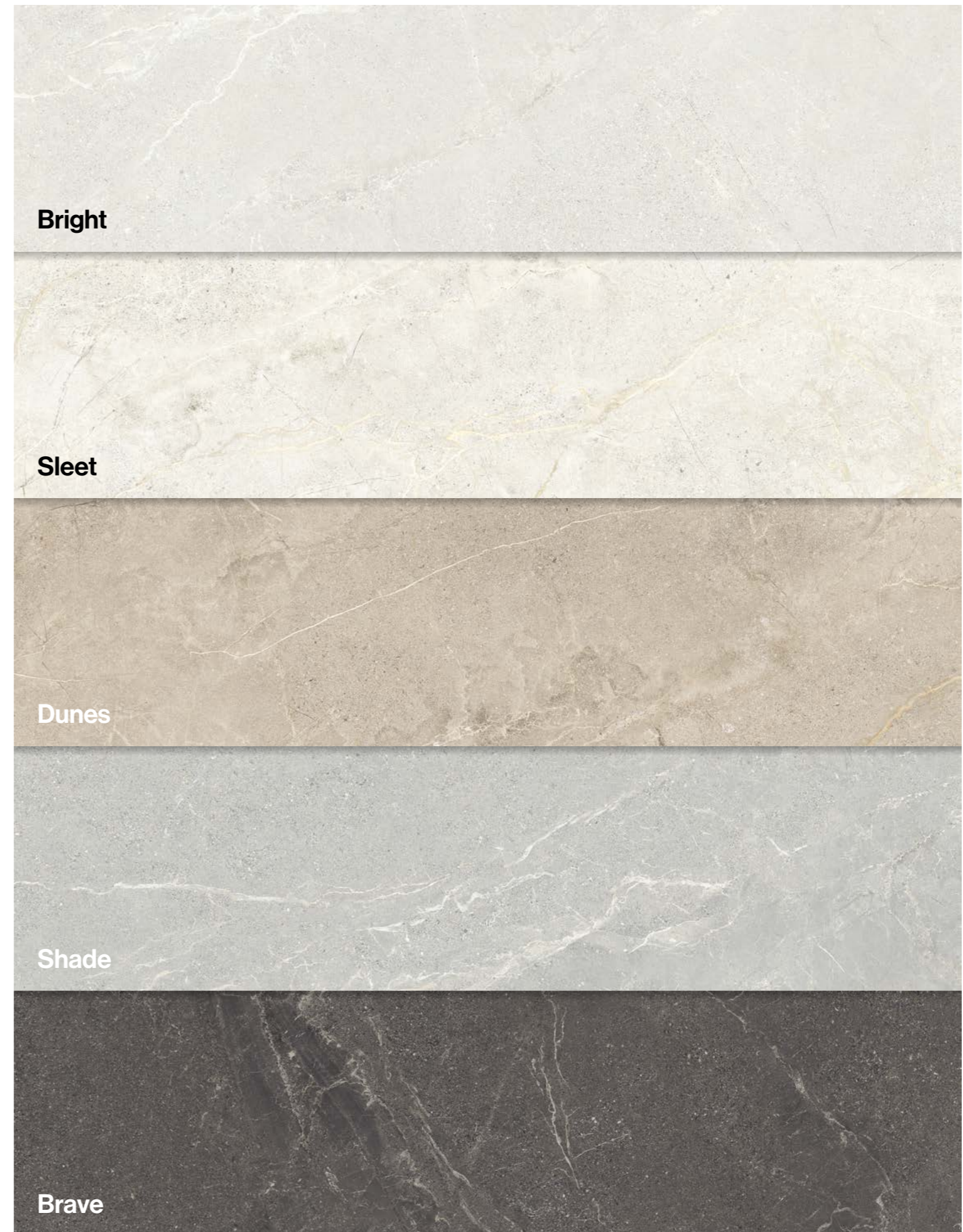

**Bright**

**Sleet**

**Dunes**

**Shade**

**Brave**

General  
index

Product  
indexes

The  
Company

## Collections

Marble Look  
Concrete Look  
**Stone Look**  
Metal Look  
Wood Look  
Cotto Look



TH2.0  
Outdoor  
Solutions

Bathroom  
furniture

Ventilated  
facades

Technical  
information

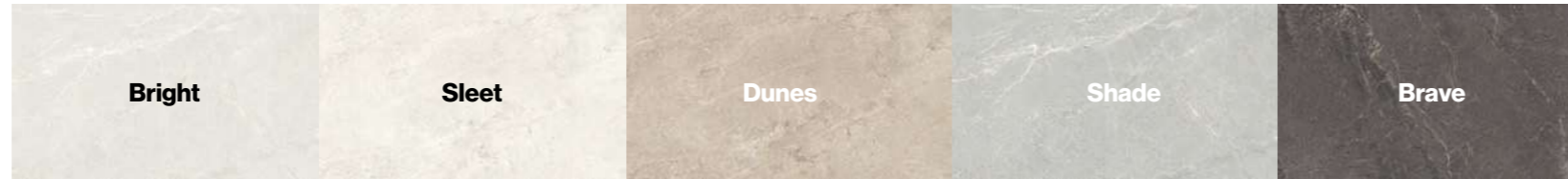

Size Formato	Finishes Finiture	Price code sqm Codice prezzo m <sup>2</sup>	Bright	Sleet	Dunes	Shade	Brave
<b>EKTREME</b> 120x280 48"x110" ⇒ 6 mm	Rectified Rettificato	162	•	•	•	•	•
<b>80x160</b> 32"x63" ⇒ 9 mm	Rectified Rettificato	150	•	•	•	•	•
<b>120x120</b> 48"x48" ⇒ 9 mm	Rectified Rettificato	155	•	•	•	•	•
<b>60x120</b> 24"x48" ⇒ 9 mm	Rectified Rettificato	146	•	•	•	•	•
	Antislip Sabbato	149	•	•	•	•	•
<b>60x60</b> 24"x24" ⇒ 9 mm	Rectified Rettificato	141	•	•	•	•	•
	Antislip Sabbato	143	•	•	•	•	•
<b>30x60</b> 12"x24" ⇒ 9 mm	Rectified Rettificato	139	•	•	•	•	•
<b>9,9x30,2</b> 4"x12" ⇒ 9 mm	Rectified Rettificato	152	•	•	•	•	•
<b>GROOVE</b> 60x120 24"x48" ⇒ 9 mm	Rectified Rettificato	151	•	•	•	•	•
<b>BATTISCOPIA</b> 6,5x120 2 1/8"x48"	Rectified Rettificato	120*	•	•	•	•	•
<b>BATTISCOPIA</b> 7,5x60 3"x24"	Rectified Rettificato	106*	•	•	•	•	•

TH2.0 OUTDOOR SOLUTIONS available   
 TH2.0 OUTDOOR SOLUTIONS disponibile

\* Price code / pc. Codice prezzo / pz.



WALL **Dunes** 120x280 . 48"x110"  
 FLOOR **Bright** 120x120 . 48"x48"

General index

Product indexes

The Company

### Collections

- Marble Look
- Concrete Look
- Stone Look**
- Metal Look
- Wood Look
- Cotto Look



TH2.0  
Outdoor  
Solutions

Bathroom  
furniture

Ventilated  
facades

Technical  
information

## Mosaics.

Mosaici. Mosaïques. Mosaik.



Bright  
MOSAICO 36PZ  
30x30 12"x12"  
NAT

Price code / pc  
Codice prezzo / pz  
**110**



Bright  
MOSAICO ESAGONI  
26x30 10"x12"  
NAT

Price code / pc  
Codice prezzo / pz  
**122**



Bright  
MOSAICO MURETTO ANTICATO  
30x30 12"x12"  
NAT

Price code / pc  
Codice prezzo / pz  
**115**



Bright  
MOSAICO MURETTO ASIMMETRICO  
30x60 12"x24"  
NAT

Price code / pc  
Codice prezzo / pz  
**123**

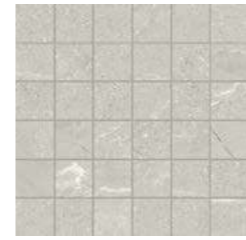

Shade  
MOSAICO 36PZ  
30x30 12"x12"  
NAT

Price code / pc  
Codice prezzo / pz  
**110**



Shade  
MOSAICO ESAGONI  
26x30 10"x12"  
NAT

Price code / pc  
Codice prezzo / pz  
**122**



Shade  
MOSAICO MURETTO ANTICATO  
30x30 12"x12"  
NAT

Price code / pc  
Codice prezzo / pz  
**115**



Shade  
MOSAICO MURETTO ASIMMETRICO  
30x60 12"x24"  
NAT

Price code / pc  
Codice prezzo / pz  
**123**



Sleet  
MOSAICO 36PZ  
30x30 12"x12"  
NAT

Price code / pc  
Codice prezzo / pz  
**110**



Sleet  
MOSAICO ESAGONI  
26x30 10"x12"  
NAT

Price code / pc  
Codice prezzo / pz  
**122**



Sleet  
MOSAICO MURETTO ANTICATO  
30x30 12"x12"  
NAT

Price code / pc  
Codice prezzo / pz  
**115**



Sleet  
MOSAICO MURETTO ASIMMETRICO  
30x60 12"x24"  
NAT

Price code / pc  
Codice prezzo / pz  
**123**

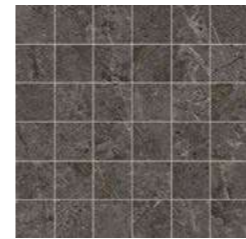

Brave  
MOSAICO 36PZ  
30x30 12"x12"  
NAT

Price code / pc  
Codice prezzo / pz  
**110**



Brave  
MOSAICO ESAGONI  
26x30 10"x12"  
NAT

Price code / pc  
Codice prezzo / pz  
**122**



Brave  
MOSAICO MURETTO ANTICATO  
30x30 12"x12"  
NAT

Price code / pc  
Codice prezzo / pz  
**115**



Brave  
MOSAICO MURETTO ASIMMETRICO  
30x60 12"x24"  
NAT

Price code / pc  
Codice prezzo / pz  
**123**



Dunes  
MOSAICO 36PZ  
30x30 12"x12"  
NAT

Price code / pc  
Codice prezzo / pz  
**110**



Dunes  
MOSAICO ESAGONI  
26x30 10"x12"  
NAT

Price code / pc  
Codice prezzo / pz  
**122**



Dunes  
MOSAICO MURETTO ANTICATO  
30x30 12"x12"  
NAT

Price code / pc  
Codice prezzo / pz  
**115**



Dunes  
MOSAICO MURETTO ASIMMETRICO  
30x60 12"x24"  
NAT

Price code / pc  
Codice prezzo / pz  
**123**





## 3D Groove texture.

Struttura 3D Groove. Structure 3D Groove. 3D Groove Textur.



Bright  
 GROOVE  
 60x120 24"x48"  
 ± 9 mm  
 RETT



Sleet  
 GROOVE  
 60x120 24"x48"  
 ± 9 mm  
 RETT



Dunes  
 GROOVE  
 60x120 24"x48"  
 ± 9 mm  
 RETT



Shade  
 GROOVE  
 60x120 24"x48"  
 ± 9 mm  
 RETT



Brave  
 GROOVE  
 60x120 24"x48"  
 ± 9 mm  
 RETT

## Pattern variation.

Sviluppo grafico. Développement graphique par format. Farbverlauf.

### Bright



60x120 24"x48"

### Sleet



60x120 24"x48"

### Dunes



60x120 24"x48"

### Shade



60x120 24"x48"

### Brave



60x120 24"x48"

# Index A - Z

Indice A - Z. Index A - Z. Alphabetisches Verzeichnis.

Flatiron  
Magnetic  
Oxidatio

# Metal Look

General  
index

Product  
indexes

The  
Company

## Collections

Marble Look  
Concrete Look  
Stone Look  
**Metal Look**  
Wood Look  
Cotto Look



TH2.0  
Outdoor  
Solutions

Bathroom  
furniture

Ventilated  
facades

Technical  
information

# Flatiron

Industrial spirit

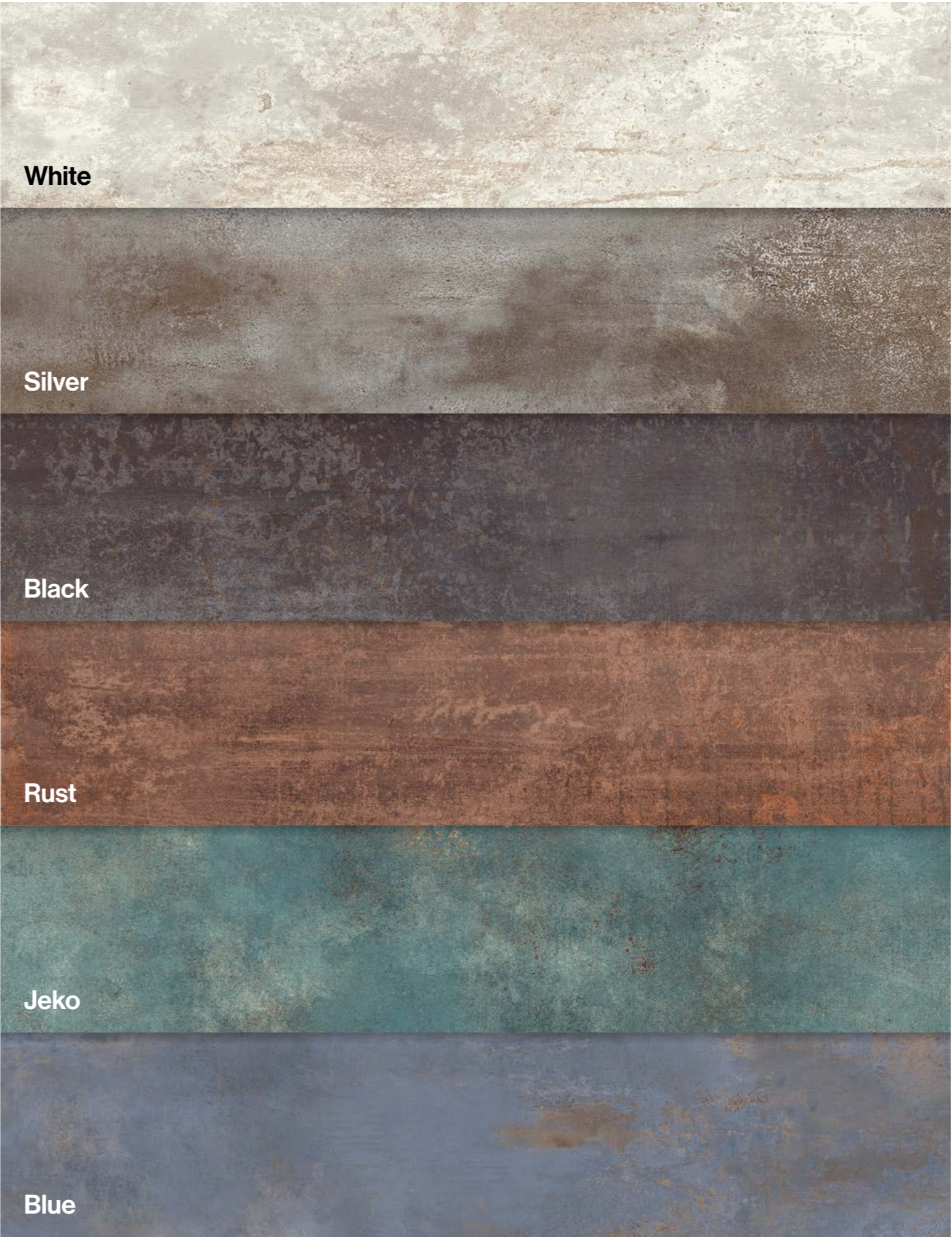

General index

Product indexes

The Company

**Collections**

- Marble Look
- Concrete Look
- Stone Look
- Metal Look**
- Wood Look
- Cotto Look



TH2.0 Outdoor Solutions

Bathroom furniture

Ventilated facades

Technical information

# Flatiron

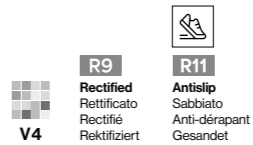

**Porcelain stoneware coloured in body**  
 Gres porcellanato colorato in massa  
 Grès cérame coloré dans la masse  
 Eingefärbtes Feinsteinzeug



Size Formato	Finishes Finiture	Price code sqm Codice prezzo m <sup>2</sup>	White	Silver	Black	Rust	Jeko	Blue
<b>EKTREME</b> 120x280 48"x110" ±6 mm	Rectified Rettificato	159	•	•	•		•	
<b>120x120</b> 48"x48" ±9 mm	Rectified Rettificato	153	•	•	•		•	
<b>60x120</b> 24"x48" ±9 mm	Rectified Rettificato	144	•	•	•	•	•	•
<b>80x80</b> 32"x32" ±9 mm	Rectified Rettificato	146	•	•	•	•	•	•
<b>60x60</b> 24"x24" ±9 mm	Rectified Rettificato	139	•	•	•	•	•	•
	Antislip Sabbiato	140	•	•				
<b>30x60</b> 12"x24" ±9 mm	Rectified Rettificato	137	•	•	•	•	•	•
<b>BATTISCOPIA</b> 6,5x120 2 1/8"x48"	Rectified Rettificato	120 *	•	•	•	•	•	•
<b>BATTISCOPIA</b> 7,5x80 3"x32"	Rectified Rettificato	109 *	•	•	•	•	•	•
<b>BATTISCOPIA</b> 7,5x60 3"x24"	Rectified Rettificato	106 *	•	•	•	•	•	•

TH2.0 OUTDOOR SOLUTIONS available ☑  
 TH2.0 OUTDOOR SOLUTIONS disponibile ☑

\* Price code / pc. Codice prezzo / pz.

General index

Product indexes

The Company

**Collections**

- Marble Look
- Concrete Look
- Stone Look
- Metal Look**
- Wood Look
- Cotto Look



TH2.0  
Outdoor  
Solutions

Bathroom  
furniture

Ventilated  
facades

Technical  
information

# Flatiron

**R9**  
Rectificato  
Rettificato  
Rektifiziert

**R11**  
Antislip  
Sabbiato  
Anti-dérapant  
Gesandet

**V4**

**Porcelain stoneware coloured in body**  
Gres porcellanato colorato in massa  
Grès cérame coloré dans la masse  
Eingefärbtes Feinsteinzeug

## Mosaics.

Mosaici. Mosaïques. Mosaik.



White  
MOSAICO 36PZ  
30x30 12"x12"  
NAT

Price code / pc  
Codice prezzo / pz  
**110**



White  
MOSAICO ASIMMETRICO 18PZ  
30x30 12"x12"  
NAT

Price code / pc  
Codice prezzo / pz  
**113**



Silver  
MOSAICO 36PZ  
30x30 12"x12"  
NAT

Price code / pc  
Codice prezzo / pz  
**110**



Silver  
MOSAICO ASIMMETRICO 18PZ  
30x30 12"x12"  
NAT

Price code / pc  
Codice prezzo / pz  
**113**



Black  
MOSAICO 36PZ  
30x30 12"x12"  
NAT

Price code / pc  
Codice prezzo / pz  
**110**



Black  
MOSAICO ASIMMETRICO 18PZ  
30x30 12"x12"  
NAT

Price code / pc  
Codice prezzo / pz  
**113**



Rust  
MOSAICO 36PZ  
30x30 12"x12"  
NAT

Price code / pc  
Codice prezzo / pz  
**110**



Rust  
MOSAICO ASIMMETRICO 18PZ  
30x30 12"x12"  
NAT

Price code / pc  
Codice prezzo / pz  
**113**



Jeko  
MOSAICO 36PZ  
30x30 12"x12"  
NAT

Price code / pc  
Codice prezzo / pz  
**110**



Jeko  
MOSAICO ASIMMETRICO 18PZ  
30x30 12"x12"  
NAT

Price code / pc  
Codice prezzo / pz  
**113**

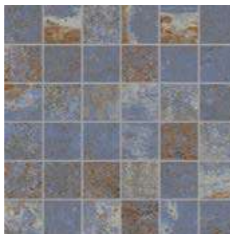

Blue  
MOSAICO 36PZ  
30x30 12"x12"  
NAT

Price code / pc  
Codice prezzo / pz  
**110**

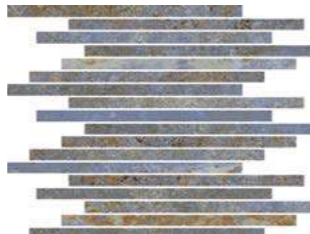

Blue  
MOSAICO ASIMMETRICO 18PZ  
30x30 12"x12"  
NAT

Price code / pc  
Codice prezzo / pz  
**113**



## Pattern variation.

Sviluppo grafico. Développement graphique par format. Farbverlauf.

### White



60x60 24"x24"

### Silver



60x60 24"x24"

### Black



60x60 24"x24"

General index

Product indexes

The Company

## Collections

- Marble Look
- Concrete Look
- Stone Look
- Metal Look**
- Wood Look
- Cotto Look



TH2.0  
Outdoor  
Solutions

Bathroom  
furniture

Ventilated  
facades

Technical  
information



# Flatiron

**Pattern variation.**  
Sviluppo grafico. Développement graphique par format. Farbverlauf.

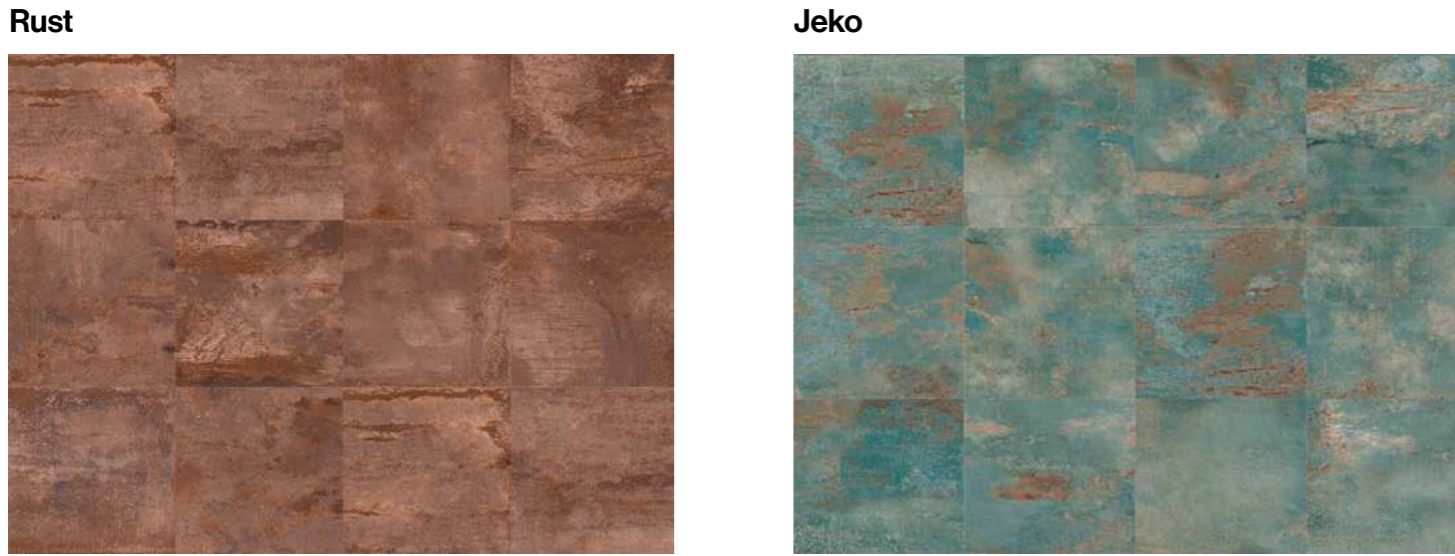

**Rust** 60x60 24"x24" **Jeko** 60x60 24"x24"



**Blue** 60x60 24"x24"

**R9** Rectificato  
Rectificato  
Rektifiziert  
**V4**

**R11** Antislip  
Sabbiato  
Anti-dérapant  
Gesandnet

Porcelain stoneware coloured in body  
Gres porcellanato colorato in massa  
Grès cérame coloré dans la masse  
Eingefärbtes Feinsteinzeug



WALL **Jeko** 120x280 . 48"x110" | **Marquiña . Black** 120x280 . 48"x110"  
FURNITURE **Jeko** 120x280 . 48"x110" | **Marquiña . Black** 120x280 . 48"x110"  
FLOOR **Jeko** 60x120 . 24"x48"

General index

Product indexes

The Company

**Collections**  
Marble Look  
Concrete Look  
Stone Look  
**Metal Look**  
Wood Look  
Cotto Look



TH2.0  
Outdoor Solutions

Bathroom furniture

Ventilated facades

Technical information

# Magnetic

The sophisticated side of metal

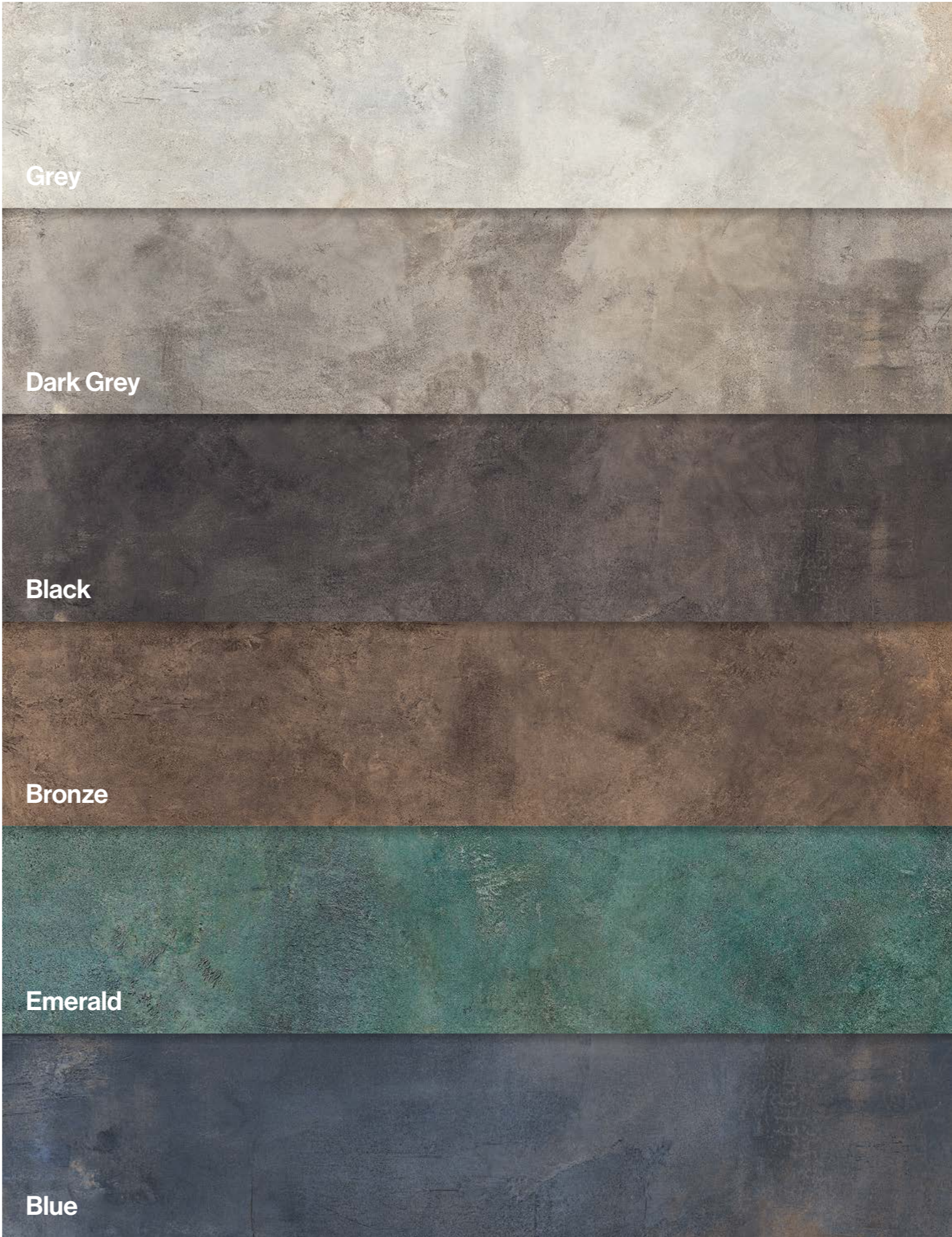

General index

Product indexes

The Company

### Collections

- Marble Look
- Concrete Look
- Stone Look
- Metal Look**
- Wood Look
- Cotto Look



TH2.0 Outdoor Solutions

Bathroom furniture

Ventilated facades

Technical information

# Magnetic

**R10**  
 Rectified  
 Rettificato  
 Rectifié  
 Rektifiziert  
**V3**

**High gloss LCP**  
 Lappato campo pieno  
 Semi-poli brillant  
 Hochglanz Lappato

**Porcelain stoneware coloured in body**  
 Gres porcellanato colorato in massa  
 Grès cérame coloré dans la masse  
 Eingefärbtes Feinsteinzeug



Size Formato	Finishes Finiture	Price code sqm Codice prezzo m²	Grey	Dark Grey	Black	Bronze	Emerald	Blue
 <b>EKTREME</b> <b>120x280</b> 48"x110" →6 mm	Rectified Rettificato	159	•	•	•	•	•	•
	High Gloss LCP Lappato campo pieno	166					•	
 <b>60x120</b> 24"x48" →9 mm	Rectified Rettificato	144	•	•	•	•	•	•
	High Gloss LCP Lappato campo pieno	153					•	
 <b>80x80</b> 32"x32" →9 mm	Rectified Rettificato	146	•	•	•	•	•	•
 <b>60x60</b> 24"x24" →9 mm	Rectified Rettificato	139	•	•	•	•	•	•
 <b>30x60</b> 12"x24" →9 mm	Rectified Rettificato	137			•		•	•
 <b>BATTISCOPA</b> <b>7,5x80</b> 3"x32"	Rectified Rettificato	109 *	•	•	•	•	•	•
 <b>BATTISCOPA</b> <b>7,5x60</b> 3"x24"	Rectified Rettificato	106 *	•	•	•	•	•	•

TH2.0 OUTDOOR SOLUTIONS available  \* Price code / pc. Codice prezzo / pz.  
 TH2.0 OUTDOOR SOLUTIONS disponibile



WALL Blue 120x280 . 48"x110"

- General index
- Product indexes
- The Company
- Collections
  - Marble Look
  - Concrete Look
  - Stone Look
  - Metal Look
  - Wood Look
  - Cotto Look
- TH2.0 Outdoor Solutions
- Bathroom furniture
- Ventilated facades
- Technical information

# Magnetic

**R10**  
 Rectified  
 Rettificato  
 Rectifié  
 Rektifiziert  
**V3**

**High gloss LCP**  
 Lappato campo pieno  
 Semi-poli brillant  
 Hochglanz Lappato

**Porcelain stoneware coloured in body**  
 Gres porcellanato colorato in massa  
 Grès cérame coloré dans la masse  
 Eingefärbtes Feinsteinzeug

## Mosaics.

Mosaici. Mosaïques. Mosaik.



Grey  
 MOSAICO 36PZ  
 30x30 12"x12"  
 NAT

Price code / pc  
 Codice prezzo / pz  
**110**



Dark Grey  
 MOSAICO 36PZ  
 30x30 12"x12"  
 NAT

Price code / pc  
 Codice prezzo / pz  
**110**



Black  
 MOSAICO 36PZ  
 30x30 12"x12"  
 NAT

Price code / pc  
 Codice prezzo / pz  
**110**



Bronze  
 MOSAICO 36PZ  
 30x30 12"x12"  
 NAT

Price code / pc  
 Codice prezzo / pz  
**110**



Emerald  
 MOSAICO 36PZ  
 30x30 12"x12"  
 NAT

Price code / pc  
 Codice prezzo / pz  
**110**



Blue  
 MOSAICO 36PZ  
 30x30 12"x12"  
 NAT

Price code / pc  
 Codice prezzo / pz  
**110**

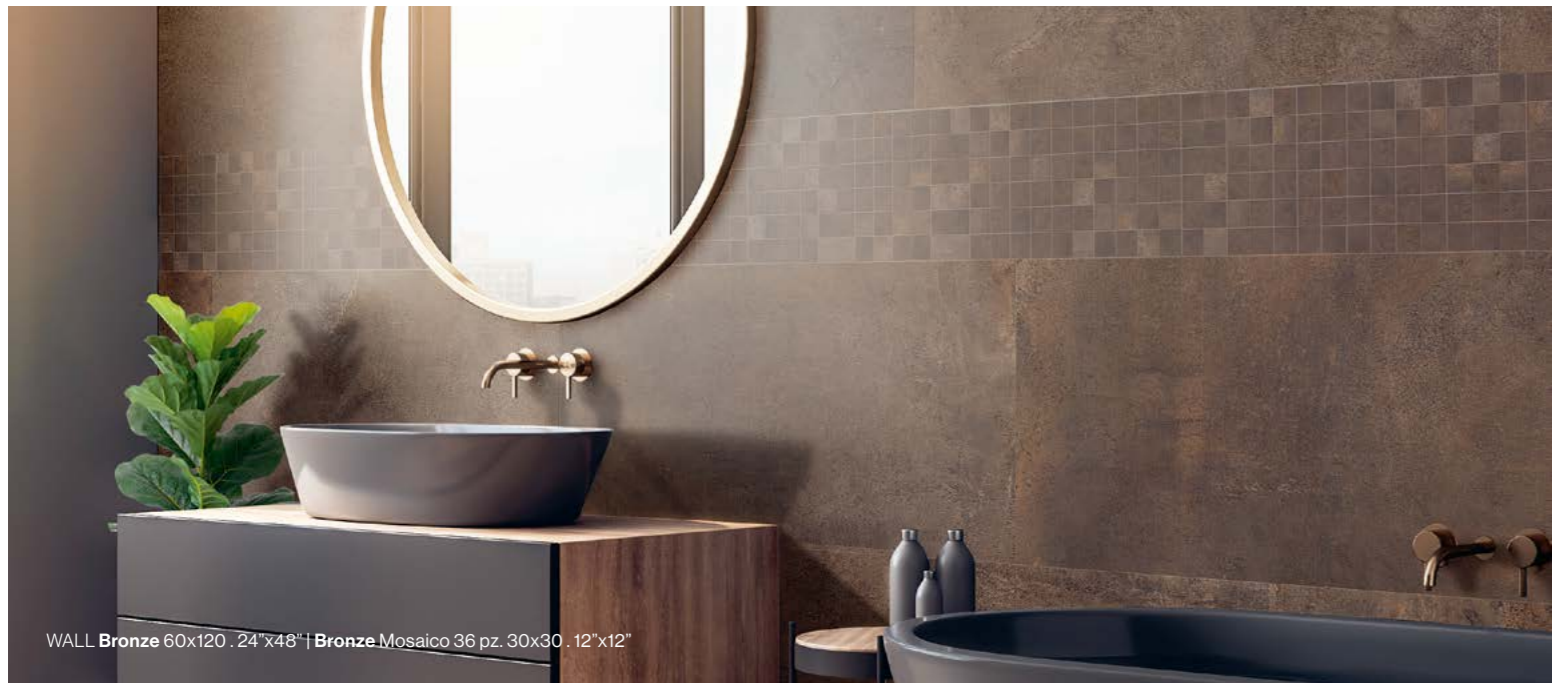

WALL Bronze 60x120 . 24"x48" | Bronze Mosaico 36 pz. 30x30 . 12"x12"

## Pattern variation.

Sviluppo grafico. Développement graphique par format. Farbverlauf.

### Grey



60x60 24"x24"

### Dark Grey



60x60 24"x24"

### Black



60x60 24"x24"

General index

Product indexes

The Company

## Collections

- Marble Look
- Concrete Look
- Stone Look
- Metal Look**
- Wood Look
- Cotto Look



TH2.0  
 Outdoor  
 Solutions

Bathroom  
 furniture

Ventilated  
 facades

Technical  
 information

# Magnetic

**R10**  
 Rettificato  
 Rettificato  
 Rectifié  
 Rektifiziert  
**V3**

**High gloss LCP**  
 Lappato campo pieno  
 Semi-poli brillant  
 Hochglanz Lappato

**Porcelain stoneware coloured in body**  
 Grès porcellanato colorato in massa  
 Grès cérame coloré dans la masse  
 Eingefärbtes Feinsteinzeug

**Pattern variation.**  
 Sviluppato grafico. Développement graphique par format. Farbverlauf.

**Bronze**



60x60 24"x24"

**Emerald**



60x60 24"x24"

**Blue**



60x60 24"x24"



WALL **Dark Grey** 120x280 . 48"x110" | **Pierre Black** 120x280 . 48"x110"  
 FURNITURE **Grey** 120x280 . 48"x110"  
 FLOOR **Dark Grey** 80x80 . 32"x32"

**Metal Look Magnetic**

General index

Product indexes

The Company

**Collections**  
 Marble Look  
 Concrete Look  
 Stone Look  
**Metal Look**  
 Wood Look  
 Cotto Look



TH2.0  
 Outdoor Solutions

Bathroom furniture

Ventilated facades

Technical information

# Oxidatio

Elegant metropolitan style



WALL Agathòs. Grey 120x280 . 48"x110"  
FLOOR Palladium 60x120 . 24"x48



Lithium

Titanium

Tellurium

Cuprum

Vanadium

Palladium

General index

Product indexes

The Company

**Collections**  
Marble Look  
Concrete Look  
Stone Look  
**Metal Look**  
Wood Look  
Cotto Look



TH2.0  
Outdoor  
Solutions

Bathroom  
furniture

Ventilated  
facades

Technical  
information

# Oxidatio

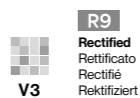

Porcelain stoneware coloured in body  
Gres porcellanato colorato in massa  
Grès cérame coloré dans la masse  
Eingefärbtes Feinsteinzeug



Size Formato	Finishes Finiture	Price code sqm Codice prezzo m <sup>2</sup>	Lithium	Titanium	Tellurium	Cuprum	Vanadium	Palladium
<b>EKTREME</b> <b>120x280</b> 48"x110" ±6 mm	Rectified Rettificato	159	•		•	•		•
<b>120x120</b> 48"x48" ±9 mm	Rectified Rettificato	153	•	•	•	•		•
<b>60x120</b> 24"x48" ±9 mm	Rectified Rettificato	144	•	•	•	•	•	•
<b>60x60</b> 24"x24" ±9 mm	Rectified Rettificato	139	•	•	•	•	•	•
<b>30x60</b> 12"x24" ±9 mm	Rectified Rettificato	137	•	•	•	•	•	•
<b>BATTISCOPA</b> <b>6,5x120</b> 2 1/8"x48"	Rectified Rettificato	120 *	•	•	•	•	•	•
<b>BATTISCOPA</b> <b>7,5x60</b> 3"x24"	Rectified Rettificato	106 *	•	•	•	•	•	•

\* Price code / pc. Codice prezzo / pz.



WALL Tellurium 60x120 - 24"x48"  
FLOOR Lithium 120x120 - 48"x48"

General index

Product indexes

The Company

Collections

- Marble Look
- Concrete Look
- Stone Look
- Metal Look**
- Wood Look
- Cotto Look



TH2.0  
Outdoor  
Solutions

Bathroom  
furniture

Ventilated  
facades

Technical  
information

# Oxidatio

R9  
Rectified  
Rettificato  
Rectifié  
Rektifiziert  
V3

Porcelain stoneware coloured in body  
Gres porcellanato colorato in massa  
Grès cérame coloré dans la masse  
Eingefärbtes Feinsteinzeug

## Mosaics.

Mosaici. Mosaïques. Mosaik.



Lithium  
MOSAICO 36PZ  
30x30 12"x12"  
NAT

Price code / pc  
Codice prezzo / pz  
**110**



Lithium  
MOSAICO ASIMMETRICO 18PZ  
30x30 12"x12"  
NAT

Price code / pc  
Codice prezzo / pz  
**113**



Titanium  
MOSAICO 36PZ  
30x30 12"x12"  
NAT

Price code / pc  
Codice prezzo / pz  
**110**



Titanium  
MOSAICO ASIMMETRICO 18PZ  
30x30 12"x12"  
NAT

Price code / pc  
Codice prezzo / pz  
**113**



Tellurium  
MOSAICO 36PZ  
30x30 12"x12"  
NAT

Price code / pc  
Codice prezzo / pz  
**110**



Tellurium  
MOSAICO ASIMMETRICO 18PZ  
30x30 12"x12"  
NAT

Price code / pc  
Codice prezzo / pz  
**113**



Cuprum  
MOSAICO 36PZ  
30x30 12"x12"  
NAT

Price code / pc  
Codice prezzo / pz  
**110**



Cuprum  
MOSAICO ASIMMETRICO 18PZ  
30x30 12"x12"  
NAT

Price code / pc  
Codice prezzo / pz  
**113**



Vanadium  
MOSAICO 36PZ  
30x30 12"x12"  
NAT

Price code / pc  
Codice prezzo / pz  
**110**



Vanadium  
MOSAICO ASIMMETRICO 18PZ  
30x30 12"x12"  
NAT

Price code / pc  
Codice prezzo / pz  
**113**



Palladium  
MOSAICO 36PZ  
30x30 12"x12"  
NAT

Price code / pc  
Codice prezzo / pz  
**110**



Palladium  
MOSAICO ASIMMETRICO 18PZ  
30x30 12"x12"  
NAT

Price code / pc  
Codice prezzo / pz  
**113**



WALL Lithium 120x280 . 48"x110" | Lithium Mosaico 36 pz. 30x30 . 12"x12"  
FLOOR Woodbreak. Ebony 30x160 . 12"x63"





# Index A - Z

Indice A - Z. Index A - Z. Alphabetisches Verzeichnis.

**Antiqua**  
**Padouk**  
**Robur**  
**Woodbreak**  
**Woodwise**

# Wood Look

**General  
index**

**Product  
indexes**

**The  
Company**

## **Collections**

Marble Look  
Concrete Look  
Stone Look  
Metal Look  
**Wood Look**  
Cotto Look



**TH2.0  
Outdoor  
Solutions**

**Bathroom  
furniture**

**Ventilated  
facades**

**Technical  
information**

# Antiqua

Always classics



FLOOR Miele 20x120 - 8"x48"

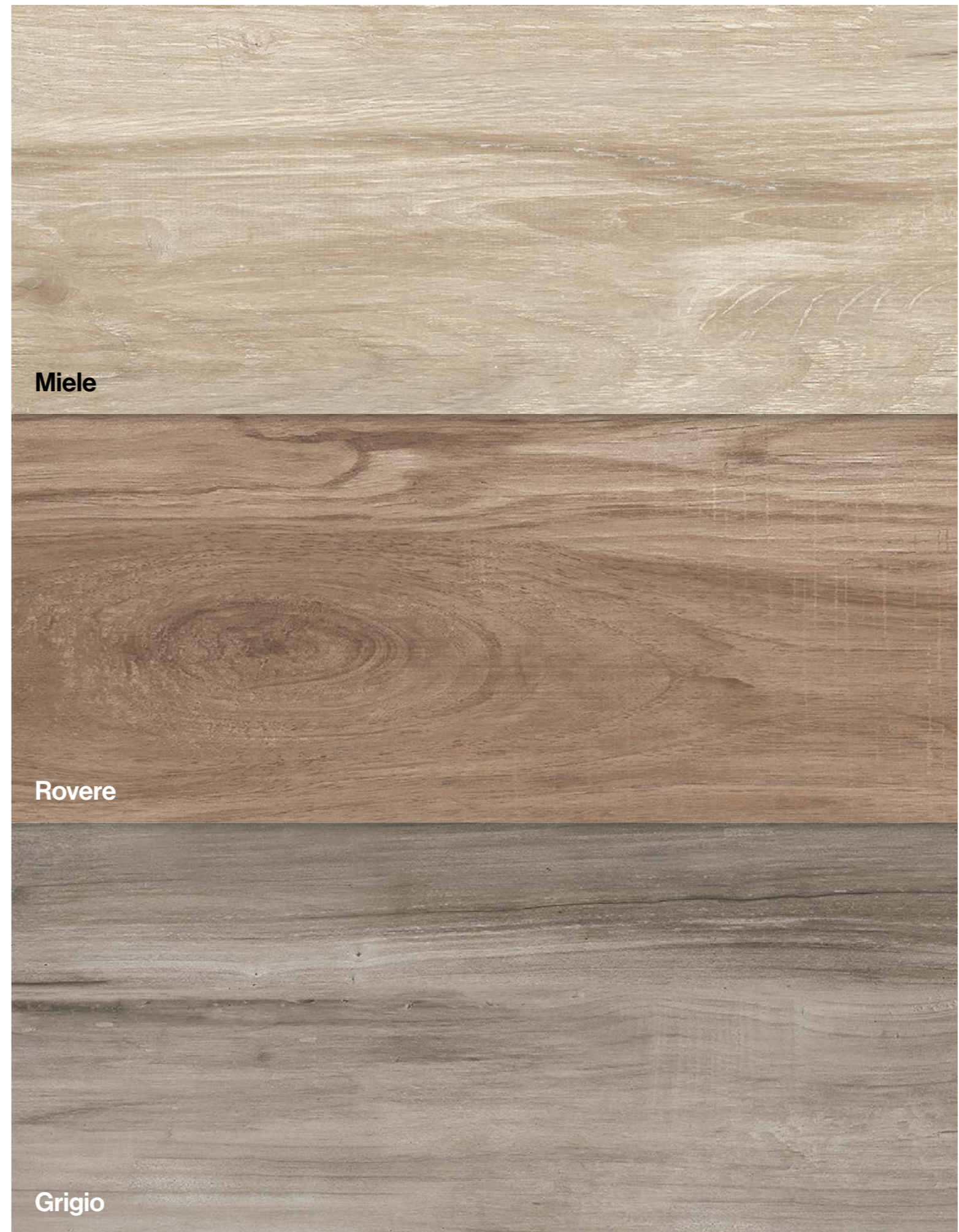

Miele

Rovere

Grigio

Wood Look Antiqua

General index

Product indexes

The Company

## Collections

- Marble Look
- Concrete Look
- Stone Look
- Metal Look
- Wood Look**
- Cotto Look



TH2.0  
Outdoor  
Solutions

Bathroom  
furniture

Ventilated  
facades

Technical  
information

# Antiqua



FLOOR Rovere 20x120 . 8"x48"

**R9**  
Rectified  
Rettificato  
Rectifié  
Rektifiziert

**R11**  
Antislip  
Sabbato  
Anti-dérapant  
Gesandet

**V3**

**Porcelain stoneware coloured in body**  
Gres porcellanato colorato in massa  
Grès cérame coloré dans la masse  
Eingefärbtes Feinsteinzeug

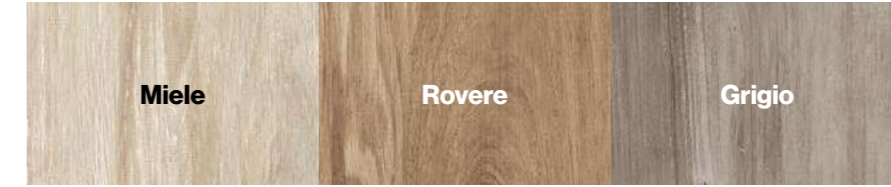

Size Formato	Finishes Finiture	Price code sqm Codice prezzo m <sup>2</sup>	Miele	Rovere	Grigio
 <b>20x120</b> 8"x48" → 9 mm	<b>Rectified</b> Rettificato	<b>143</b>	•	•	•
	<b>Antislip</b> Sabbato	<b>144</b>	•	•	•
 <b>BATTISCOPA</b> <b>6,5x120</b> 2 1/4" x 48"	<b>Rectified</b> Rettificato	<b>120 *</b>	•	•	•
 <b>ELEMENTO "L"</b> <b>INCOLLATO</b> <b>20x120x5</b> 8"x48" x 2"	<b>Rectified</b> Rettificato	<b>152 *</b>	•	•	•

\* Price code / pc. Codice prezzo / pz.

## Mosaics.

Mosaici. Mosaiques. Mosaik.



Miele  
MOSAICO 36PZ  
30x30 12"x12"  
NAT

Price code / pc  
Codice prezzo / pz  
**110**



Rovere  
MOSAICO 36PZ  
30x30 12"x12"  
NAT

Price code / pc  
Codice prezzo / pz  
**110**



Grigio  
MOSAICO 36PZ  
30x30 12"x12"  
NAT

Price code / pc  
Codice prezzo / pz  
**110**



General  
index

Product  
indexes

The  
Company

## Collections

Marble Look  
Concrete Look  
Stone Look  
Metal Look  
**Wood Look**  
Cotto Look



TH2.0  
Outdoor  
Solutions

Bathroom  
furniture

Ventilated  
facades

Technical  
information

# Padouk

Reimagined wood style



General index

Product indexes

The Company

**Collections**

- Marble Look
- Concrete Look
- Stone Look
- Metal Look
- Wood Look**
- Cotto Look



TH2.0 Outdoor Solutions

Bathroom furniture

Ventilated facades

Technical information



Size Formato	Finishes Finiture	Price code sqm Codice prezzo m²	White	Beige	Nut	Grey
<b>30x160</b> 12"x63" ⇒9 mm	Rectified Rettificato	150	•	•	•	•
<b>20x160</b> 8"x63" ⇒9 mm	Rectified Rettificato	150	•	•	•	•
<b>60x120</b> 24"x48" ⇒9 mm	Rectified Rettificato	144	•	•	•	•
<b>30x120</b> 12"x48" ⇒9 mm	Rectified Rettificato	143	•	•	•	•
	Antislip Sabbato	144	•	•	•	•
<b>20x120</b> 8"x48" ⇒9 mm	Rectified Rettificato	143	•	•	•	•
	Antislip Sabbato	144	•	•	•	•
<b>BATTISCOPIA</b> <b>6,5x120</b> 2 9/16"x48"	Rectified Rettificato	120*	•	•	•	•
<b>ELEMENTO "L"</b> <b>INCOLLATO</b> <b>30x120x5</b> 12"x48"x2"	Rectified Rettificato	152*	•	•	•	•
<b>ELEMENTO "L"</b> <b>INCOLLATO</b> <b>20x120x5</b> 8"x48"x2"	Rectified Rettificato	152*	•	•	•	•

TH2.0 OUTDOOR SOLUTIONS available

TH2.0 OUTDOOR SOLUTIONS disponibile

\* Price code / pc. Codice prezzo / pz.

## Mosaics.

Mosaici. Mosaïques. Mosaik.



White  
MOSAICO 36PZ  
30x30 12"x12"  
NAT

Price code / pc  
Codice prezzo / pz  
**110**



Beige  
MOSAICO 36PZ  
30x30 12"x12"  
NAT

Price code / pc  
Codice prezzo / pz  
**110**



Nut  
MOSAICO 36PZ  
30x30 12"x12"  
NAT

Price code / pc  
Codice prezzo / pz  
**110**



Grey  
MOSAICO 36PZ  
30x30 12"x12"  
NAT

Price code / pc  
Codice prezzo / pz  
**110**



FLOOR Beige 20x160 . 8"x63"

# Robur

Resilient by nature



FLOOR Pecan 30x120 . 12"x48"



Oat

Honey

Pecan

Cocoa

General index

Product indexes

The Company

### Collections

- Marble Look
- Concrete Look
- Stone Look
- Metal Look
- Wood Look**
- Cotto Look



TH2.0  
Outdoor  
Solutions

Bathroom  
furniture

Ventilated  
facades

Technical  
information



Size Formato	Finishes Finiture	Price code sqm Codice prezzo m <sup>2</sup>	Oat	Honey	Pecan	Cocoa
<b>30x160</b> 12"x63" →9 mm	Rectified Rettificato	150	•	•	•	•
<b>20x160</b> 8"x63" →9 mm	Rectified Rettificato	150	•	•	•	•
<b>30x120</b> 12"x48" →9 mm	Rectified Rettificato	143	•	•	•	•
	Antislip Sabbiato	144	•	•	•	•
<b>20x120</b> 8"x48" →9 mm	Rectified Rettificato	143	• UPEC	• UPEC	• UPEC	• UPEC
	Antislip Sabbiato	144	•	•	•	•
<b>CHEVRON</b> <b>9,5x57</b> 4"x22" →9 mm	Rectified Rettificato	169	•	•	•	•
<b>BATTISCOPA</b> <b>6,5x120</b> 2 1/8"x48"	Rectified Rettificato	120*	•	•	•	•
<b>ELEMENTO "L" INCOLLATO</b> <b>30x120x5</b> 12"x48"x2"	Rectified Rettificato	152*	•	•	•	•
	Rectified Rettificato	152*	•	•	•	•

TH2.0 OUTDOOR SOLUTIONS available   
TH2.0 OUTDOOR SOLUTIONS disponibile

\* Price code / pc. Codice prezzo / pz.



FLOOR Pecan Chevron 9,5x57 . 4" x22"

Wood Look Robur

General index

Product indexes

The Company

### Collections

- Marble Look
- Concrete Look
- Stone Look
- Metal Look
- Wood Look**
- Cotto Look



TH2.0  
Outdoor  
Solutions

Bathroom  
furniture

Ventilated  
facades

Technical  
information

# Woodbreak

Cozy design feelings



FLOOR Ebony 20x120 .8"x48"

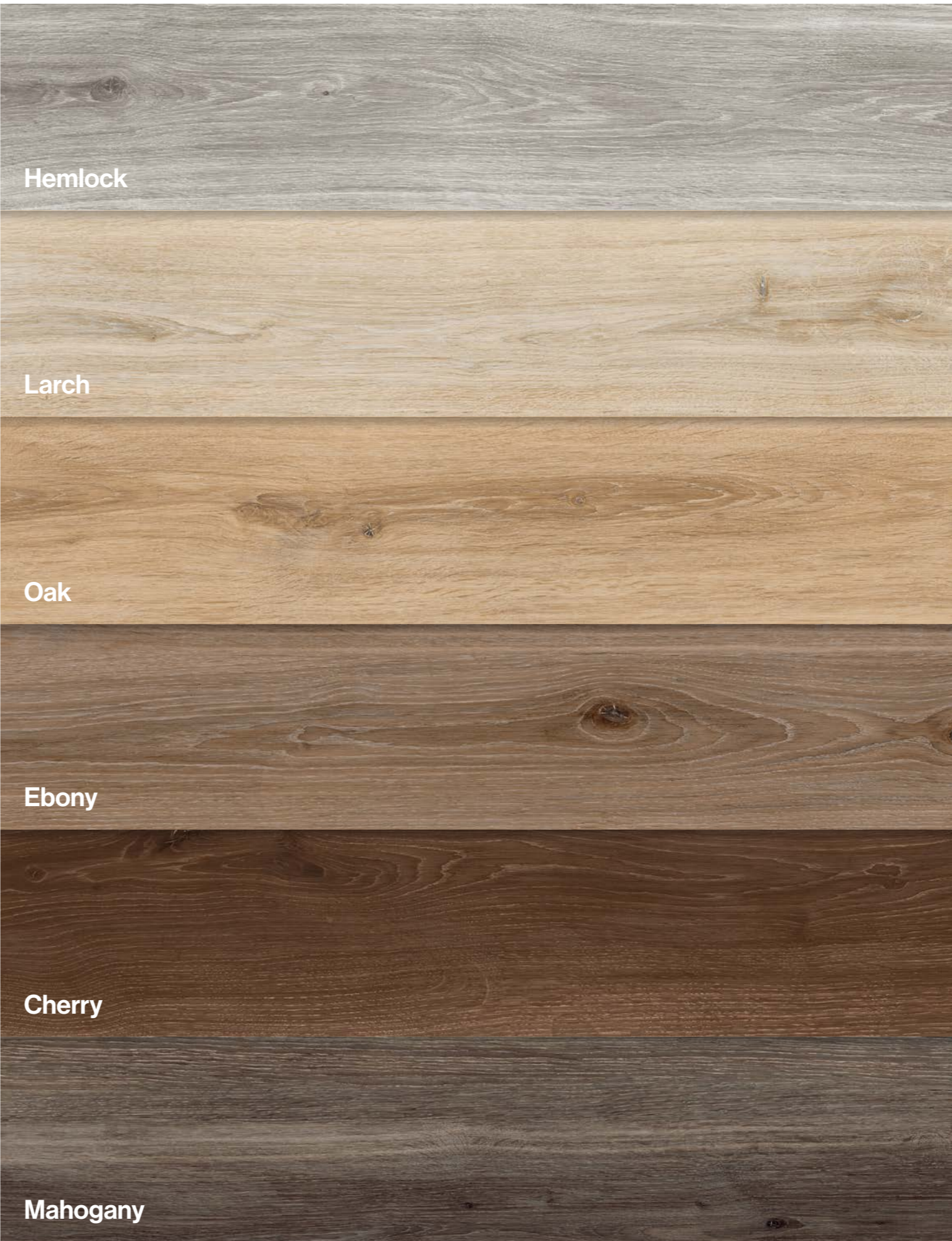

Hemlock

Larch

Oak

Ebony

Cherry

Mahogany

General index

Product indexes

The Company

**Collections**  
 Marble Look  
 Concrete Look  
 Stone Look  
 Metal Look  
**Wood Look**  
 Cotto Look



TH2.0 Outdoor Solutions

Bathroom furniture

Ventilated facades

Technical information



# Woodbreak

**V3**

**R9**  
Rectificato  
Rettificato  
Rektifiziert

**R11**  
Antislip  
Sabbliato  
Anti-dérapant  
Gesandet

**Porcelain stoneware coloured in body**  
Gres porcellanato colorato in massa  
Grès cérame coloré dans la masse  
Eingefärbtes Feinsteinzeug



Size Formato	Finishes Finiture	Price code sqm Codice prezzo m²	Hemlock	Larch	Oak	Ebony	Cherry	Mahogany
<b>30x160</b> 12"x63" →9 mm	Rectified Rettificato	150	•	•	•	•		
<b>20x160</b> 8"x63" →9 mm	Rectified Rettificato	150	•	•	•	•		
<b>30x120</b> 12"x48" →9 mm	Rectified Rettificato	143	•	•	•	•		
<b>20x120</b> 8"x48" →9 mm	Rectified Rettificato	143	•	•	•	•	•	•
	Antislip Sabbliato	144	•	•	•	•	•	•
<b>BATTISCOPA</b> <b>6,5x120</b> 2 1/4"x48"	Rectified Rettificato	120*	•	•	•	•	•	•
<b>ELEMENTO "L"</b> <b>INCOLLATO</b> <b>30x120x5</b> 12"x48"x2"	Rectified Rettificato	152*	•	•	•	•		
	Rectified Rettificato	152*	•	•	•	•	•	•

TH2.0 OUTDOOR SOLUTIONS available **TH2.0 OUTDOORSOLUTIONS** disponibile \* Price code / pc. Codice prezzo / pz.



FLOOR Oak 30x160 . 12"x63"



FLOOR Mahogany 20x120 . 8"x48"

General index

Product indexes

The Company

**Collections**  
Marble Look  
Concrete Look  
Stone Look  
Metal Look  
**Wood Look**  
Cotto Look



TH2.0 Outdoor Solutions

Bathroom furniture

Ventilated facades

Technical information

# Woodwise

Natural harmony



General index

Product indexes

The Company

### Collections

- Marble Look
- Concrete Look
- Stone Look
- Metal Look
- Wood Look**
- Cotto Look



TH2.0 Outdoor Solutions

Bathroom furniture

Ventilated facades

Technical information



Size Formato	Finishes Finiture	Price code sqm Codice prezzo m <sup>2</sup>	Caramel	Cedar	Auburn	Brandy
<b>EKTREME</b> <b>120x280</b> 48"x110" → 6 mm	Rectified Rettificato	161			•	
<b>30x160</b> 12"x63" → 6 mm	Rectified Rettificato	153	•	•	•	•
<b>30x120</b> 12"x48" → 6 mm	Rectified Rettificato	147	•	•	•	•
<b>20x120</b> 8"x48" → 6 mm	Rectified Rettificato	147	•	•	•	•
<b>20x120</b> 8"x48" → 6 mm	Antislip Sabbiato	149	•	•	•	•
<b>BATTISCOPA</b> <b>6,5x120</b> 2 1/8"x48"	Rectified Rettificato	120*	•	•	•	•

\* Price code / pc. Codice prezzo / pz.

**Decors.**  
Decori. Décors. Dekore.



FLUTED  
**60x120** 24"x48"  
→ 6 mm  
RETT  
Price code / pc  
Codice prezzo / pz  
**153**

FLUTED  
**120x280** 48"x110"  
→ 6 mm  
RETT  
Price code / pc  
Codice prezzo / pz  
**164**



WALL **Fluted** 120x280 48"x110"  
FLOOR **Auburn** 30x160 12"x63"

# Index A - Z

Indice A - Z. Index A - Z. Alphabetisches Verzeichnis.

**Antichi Amori**  
**Campigiane**  
**Montecchio**  
**Maioliche**

# Cotto Look

**General index**

**Product indexes**

**The Company**

## **Collections**

Marble Look  
Concrete Look  
Stone Look  
Metal Look  
Wood Look  
**Cotto Look**



**TH2.0  
Outdoor  
Solutions**

**Bathroom  
furniture**

**Ventilated  
facades**

**Technical  
information**

# Antichi Amori

Warm and materic



FLOOR Canossa 15x30 . 6"x12"



Torrechiara

Canossa

Rossena

General index

Product indexes

The Company

## Collections

- Marble Look
- Concrete Look
- Stone Look
- Metal Look
- Wood Look
- Cotto Look**



TH2.0  
Outdoor  
Solutions

Bathroom  
furniture

Ventilated  
facades

Technical  
information

# Antichi Amori



FLOOR Torrechiarà 30x30 . 12"x12" | 15x30 . 6"x12"

V2  
R9  
Natural  
Naturale  
Natur  
R11  
Antislip  
Sabbato  
Anti-dérappant  
Gesandet

Porcelain stoneware  
Gres porcellanato  
Grès cérame coloré  
Feinsteinzeug

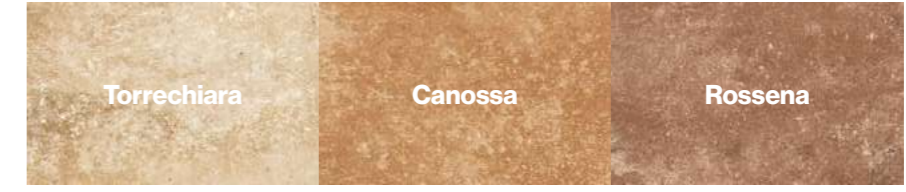

Size Formato	Finishes Finiture	Price code sqm Codice prezzo m²	Torrechiara	Canossa	Rossena
<b>30x30</b> 12"x12" →9,2mm	Natural Naturale	127	•	•	•
<b>15x30</b> 6"x12" →9,2mm	Natural Naturale	127	•	•	•
BATTISCOPA <b>7,5x30</b> 3"x12"	Natural Naturale	101*	•	•	•
GRADONE LINEARE CON TORO APPLICATO <b>30x30</b> 12"x12"	Natural Naturale	131*	•	•	•
GRADONE ANGOLARE CON TORO APPLICATO <b>30x30</b> 12"x12"	Natural Naturale	142*	•	•	•

\* Price code / pc. Codice prezzo / pz.

General index

Product indexes

The Company

## Collections

- Marble Look
- Concrete Look
- Stone Look
- Metal Look
- Wood Look
- Cotto Look



TH2.0  
Outdoor  
Solutions

Bathroom  
furniture

Ventilated  
facades

Technical  
information

# Campigiane

Rustic classic



FLOOR Rame 15x30 . 6"x12"



Rosata

Oro

Rame

Bronzo

General index

Product indexes

The Company

## Collections

Marble Look  
Concrete Look  
Stone Look  
Metal Look  
Wood Look  
Cotto Look



TH2.0  
Outdoor  
Solutions

Bathroom  
furniture

Ventilated  
facades

Technical  
information

# Campigiane

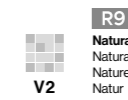

R9  
Natural  
Naturale  
Natur

Porcelain stoneware  
Gres porcellanato  
Grès cérame coloré  
Feinsteinzeug



Size Formato	Finishes Finiture	Price code sqm Codice prezzo m <sup>2</sup>	Rosata	Oro	Rame	Bronzo
<b>30x30</b> 12"x12" ⇒9,2 mm	Natural Naturale	127	•	•	•	•
<b>15x30</b> 6"x12" ⇒9,2 mm	Natural Naturale	127	•	•	•	•
<b>BATTISCOPA</b> <b>7,5x30</b> 3"x12"	Natural Naturale	101*	•	•	•	•
<b>GRADONE</b> <b>LINEARE CON</b> <b>TORO APPLICATO</b> <b>30x30</b> 12"x12"	Natural Naturale	131*	•	•	•	•
<b>GRADONE</b> <b>ANGOLARE CON</b> <b>TORO APPLICATO</b> <b>30x30</b> 12"x12"	Natural Naturale	142*	•	•	•	•
<b>ELEMENTO "L"</b> <b>INCOLLATO</b> <b>15x30x5</b> 6"x12"x2"	Natural Naturale	108*	•	•	•	•

\* Price code / pc. Codice prezzo / pz.



WALL Rosata 15x30 . 6"x12"  
FLOOR Rosata 30x30 . 12"x12"

Cotto Look Campigiane

General  
index

Product  
indexes

The  
Company

Collections  
Marble Look  
Concrete Look  
Stone Look  
Metal Look  
Wood Look  
Cotto Look



TH2.0  
Outdoor  
Solutions

Bathroom  
furniture

Ventilated  
facades

Technical  
information



# Montecchio

The imprint of time



FLOOR Rame 15x30 - 6"x12"



Gesso



Rame



Cuoio

General index

Product indexes

The Company

### Collections

- Marble Look
- Concrete Look
- Stone Look
- Metal Look
- Wood Look
- Cotto Look



TH2.0 Outdoor Solutions

Bathroom furniture

Ventilated facades

Technical information

# Montecchio



FLOOR Cuoio 15x30 - 6"x12"

**R10**  
Natural  
Naturale  
Natur  
**V3**

**Porcelain stoneware**  
Gres porcellanato  
Grès cérame coloré  
Feinsteinzeug

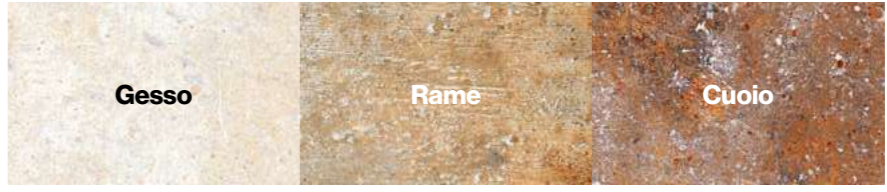

Size Formato	Finishes Finiture	Price code sqm Codice prezzo m <sup>2</sup>	Gesso	Rame	Cuoio
<b>15x30</b> 6"x12" ⇒ 8,2 mm	Natural Naturale	124	•	•	•
<b>BATTISCOPIA</b> <b>7,5x30</b> 3"x12"	Natural Naturale	101*	•	•	•
<b>ELEMENTO "L"</b> <b>INCOLLATO</b> <b>15x30x5</b> 6"x12"x2"	Natural Naturale	108*	•	•	•
<b>ELEMENTO "L"</b> <b>MONOLITICO</b> <b>15x30x3,5</b> 6"x12"x1"	Natural Naturale	119*	•	•	•

\* Price code / pc. Codice prezzo / pz.

General index

Product indexes

The Company

- Collections**
- Marble Look
  - Concrete Look
  - Stone Look
  - Metal Look
  - Wood Look
  - Cotto Look

TH2.0  
Outdoor  
Solutions

Bathroom  
furniture

Ventilated  
facades

Technical  
information

# Maioliche

Ceramic art reborn



Porcelain stoneware  
Gres porcellanato  
Grès cérame coloré  
Feinsteinzeug

General index

Product indexes

The Company

### Collections

- Marble Look
- Concrete Look
- Stone Look
- Metal Look
- Wood Look
- Cotto Look



TH2.0  
Outdoor  
Solutions

Bathroom  
furniture

Ventilated  
facades

Technical  
information



WALL Mix 20x20 - 8"x8"



Maioliche Mix  
20x20 8"x8"  
GLOSSY  
±7,2 mm  
Price code / sqm  
Codice prezzo / m²  
141



WALL Mix 20x20 - 8"x8"

Cotto Look Maioliche

# Index A - Z

Indice A - Z. Index A - Z. Alphabetisches Verzeichnis.

---

## Marble Look

Calacatta  
Navona Soft  
Navona Vein

---

## Concrete Look

Brera  
Loft  
Parker

---

## Stone Look

Agathòs  
Basaltina  
Ceppo di Grè  
Genesis  
Heritage  
Hollstone  
Loop  
Medley  
Nereidi  
Pennslate  
Pietra di Vals  
Rushmore  
Spark  
Sunstone  
Urano  
Wonder

---

## Metal Look

Flatiron  
Magnetic

---

## Wood Look

Padouk  
Robur  
Woodbreak

# TH2.0 Outdoor Solutions

General  
index

Product  
indexes

The  
Company

Collections

TH2.0  
Outdoor  
Solutions

Marble Look  
Concrete Look  
Stone Look  
Metal Look  
Wood Look  
Special pieces



Bathroom  
furniture

Ventilated  
facades

Technical  
information

# Exceptional beauty and performance

Estetica e performance eccezionali  
Beauté et performance exceptionnelles  
Außergewöhnliche Schönheit und Leistung

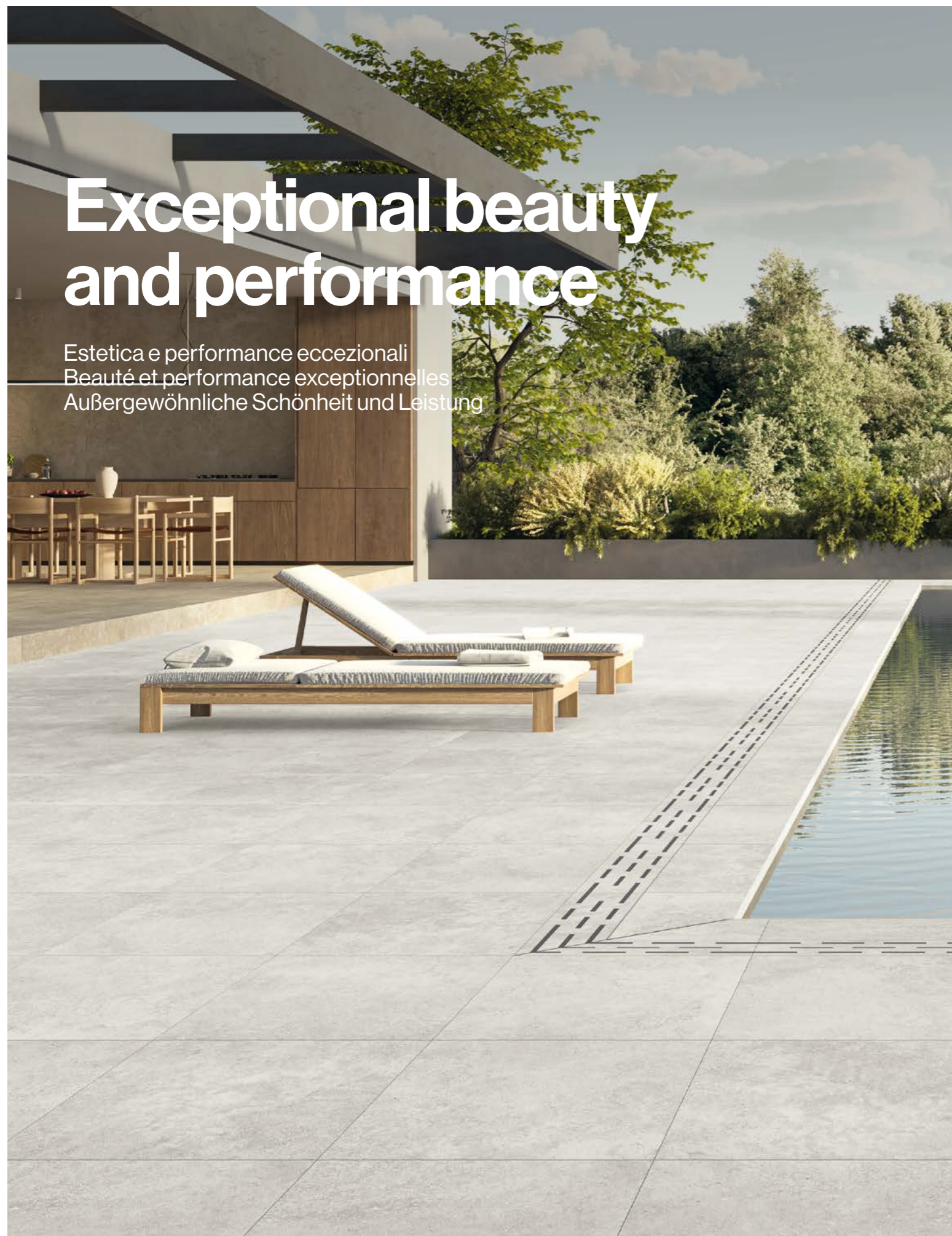

**The TH2.0 Outdoor Solutions collections offer over 30 surfaces and a wide range of sizes to meet any design requirement. Suitable for different installation systems, they guarantee versatility, ease of installation, and excellent performance in every context.**

Le collezioni TH2.0 Outdoor Solutions offrono oltre 30 superfici e un'ampia scelta di formati per rispondere a qualsiasi esigenza progettuale. Adatte a diversi sistemi di posa, garantiscono versatilità, facilità d'installazione e prestazioni eccellenti in ogni contesto.

Les collections TH2.0 Outdoor Solutions offrent plus de 30 surfaces et un large choix de formats pour répondre à tous les besoins de conception. Adaptées à différents systèmes de pose, elles garantissent polyvalence, facilité d'installation et excellentes performances dans tous les contextes.

Die TH2.0 Outdoor Solutions Kollektionen bieten über 30 Oberflächen und eine große Auswahl an Formaten, um allen gestalterischen Anforderungen gerecht zu werden. Geeignet für verschiedene Verlegesysteme, garantieren sie Vielseitigkeit, einfache Installation und hervorragende Leistung in jedem Kontext.

General index

Product indexes

The Company

Collections

**TH2.0 Outdoor Solutions**

Marble Look  
Concrete Look  
Stone Look  
Metal Look  
Wood Look  
Special pieces



Bathroom furniture

Ventilated facades

Technical information

# Calacatta

Timeless elegance

Marble Look



FLOOR Calacatta 60x120 .24"x48" TH2.0

V2

R11  
 Rettificato  
 Rectificado  
 Rektifiziert

Porcelain stoneware coloured in body  
 Gres porcellanato colorato in massa  
 Grès cérame coloré dans la masse  
 Eingefärbtes Feinsteinzeug



Size Formato	Finishes Finiture	Price code sqm Codice prezzo m²
 <b>60x120</b> 24"x48" → 20 mm	<b>Rectified</b> Rettificato	<b>155</b>
 <b>60x60</b> 24"x24" → 20 mm	<b>Rectified</b> Rettificato	<b>151</b>

TH2.0 OUTDOOR SOLUTIONS special pieces [↗](#)  
 TH2.0 OUTDOOR SOLUTIONS pezzi speciali [↗](#)



FLOOR Calacatta 60x120 .24"x48" TH2.0

General index

Product indexes

The Company

Collections

TH2.0  
 Outdoor  
 Solutions

- Marble Look
- Concrete Look
- Stone Look
- Metal Look
- Wood Look
- Special pieces

Bathroom furniture

Ventilated facades

Technical information

# Navona Soft

Iconic classic surface

Marble Look



FLOOR **Soft Aureo** 60x90 . 24"x36" TH2.0



V3

R11  
 Rettificato  
 Rectifié  
 Rektifiziert

Porcelain stoneware coloured in body  
 Gres porcellanato colorato in massa  
 Grès cérame coloré dans la masse  
 Eingefärbtes Feinsteinzeug



Size Formato	Finishes Finiture	Price code sqm Codice prezzo m²		
<b>60x90</b> 24"x36" ⇒ 20 mm	Rectified Rettificato	157	•	•
<b>80x80</b> 32"x32" ⇒ 20 mm	Rectified Rettificato	156	•	•
<b>60x60</b> 24"x24" ⇒ 20 mm	Rectified Rettificato	151	•	•

TH2.0 OUTDOOR SOLUTIONS special pieces [↗](#)  
 TH2.0 OUTDOOR SOLUTIONS pezzi speciali [↗](#)



FLOOR **Soft Niveo** 80x80 . 32"x32" TH2.0

General index

Product indexes

The Company

Collections

TH2.0  
Outdoor  
Solutions

- Marble Look
- Concrete Look
- Stone Look
- Metal Look
- Wood Look
- Special pieces



Bathroom furniture

Ventilated facades

Technical information

# Navona Vein

Iconic marble vein

Marble Look



FLOOR Vein Candido 60x90 . 24"x36" TH2.0

V3

R11  
 Rettificato  
 Rectifié  
 Rektifiziert

Porcelain stoneware coloured in body  
 Gres porcellanato colorato in massa  
 Grès cérame coloré dans la masse  
 Eingefärbtes Feinsteinzeug



Size Formato	Finishes Finiture	Price code sqm Codice prezzo m²	•	•
60x120 24"x48" → 20 mm	Rectified Rettificato	155	•	•
60x90 24"x36" → 20 mm	Rectified Rettificato	157	•	•

TH2.0 OUTDOOR SOLUTIONS special pieces

TH2.0 OUTDOOR SOLUTIONS pezzi speciali



TH2.0 Navona Vein

General index

Product indexes

The Company

Collections

TH2.0 Outdoor Solutions

Marble Look

Concrete Look

Stone Look

Metal Look

Wood Look

Special pieces



Bathroom furniture

Ventilated facades

Technical information



# Brera

Milan style attitude

Concrete Look



Porcelain stoneware coloured in body  
Gres porcellanato colorato in massa  
Grès cérame coloré dans la masse  
Eingefärbtes Feinsteinzeug

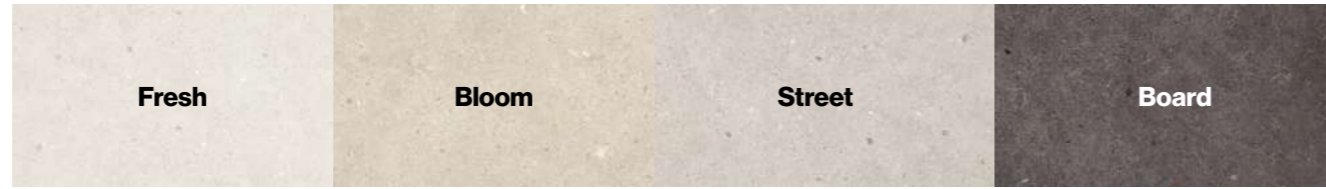

Size Formato	Finishes Finiture	Price code sqm Codice prezzo m <sup>2</sup>	Fresh	Bloom	Street	Board
 <b>60x120</b> 24"x48" →20 mm	Rectified Rettificato	155	●	●	●	●
 <b>60x60</b> 24"x24" →20 mm	Rectified Rettificato	151	●	●	●	●

TH2.0 OUTDOOR SOLUTIONS special pieces [↗](#)  
 TH2.0 OUTDOOR SOLUTIONS pezzi speciali [↗](#)



FLOOR Board 60x120 . 24"x48" TH2.0



FLOOR Street 60x60 . 24"x24" TH2.0

General index

Product indexes

The Company

Collections

TH2.0  
Outdoor  
Solutions

- Marble Look
- Concrete Look
- Stone Look
- Metal Look
- Wood Look
- Special pieces



Bathroom furniture

Ventilated facades

Technical information



Size Formato	Finishes Finiture	Price code sqm Codice prezzo m <sup>2</sup>	Cream	Taupe	Ash	Grey
<b>120x120</b> 48"x48" ±20 mm	Rectified Rettificato	165			●	
<b>60x120</b> 24"x48" ±20 mm	Rectified Rettificato	155	●	●	●	●
<b>80x80</b> 32"x32" ±20 mm	Rectified Rettificato	156	●	●	●	●
<b>60x60</b> 24"x24" ±20 mm	Rectified Rettificato	151	●	●	●	●

TH2.0 OUTDOOR SOLUTIONS special pieces   
TH2.0 OUTDOORSOLUTIONS pezzi speciali



FLOOR Cream 80x80 . 32"x32" TH2.0

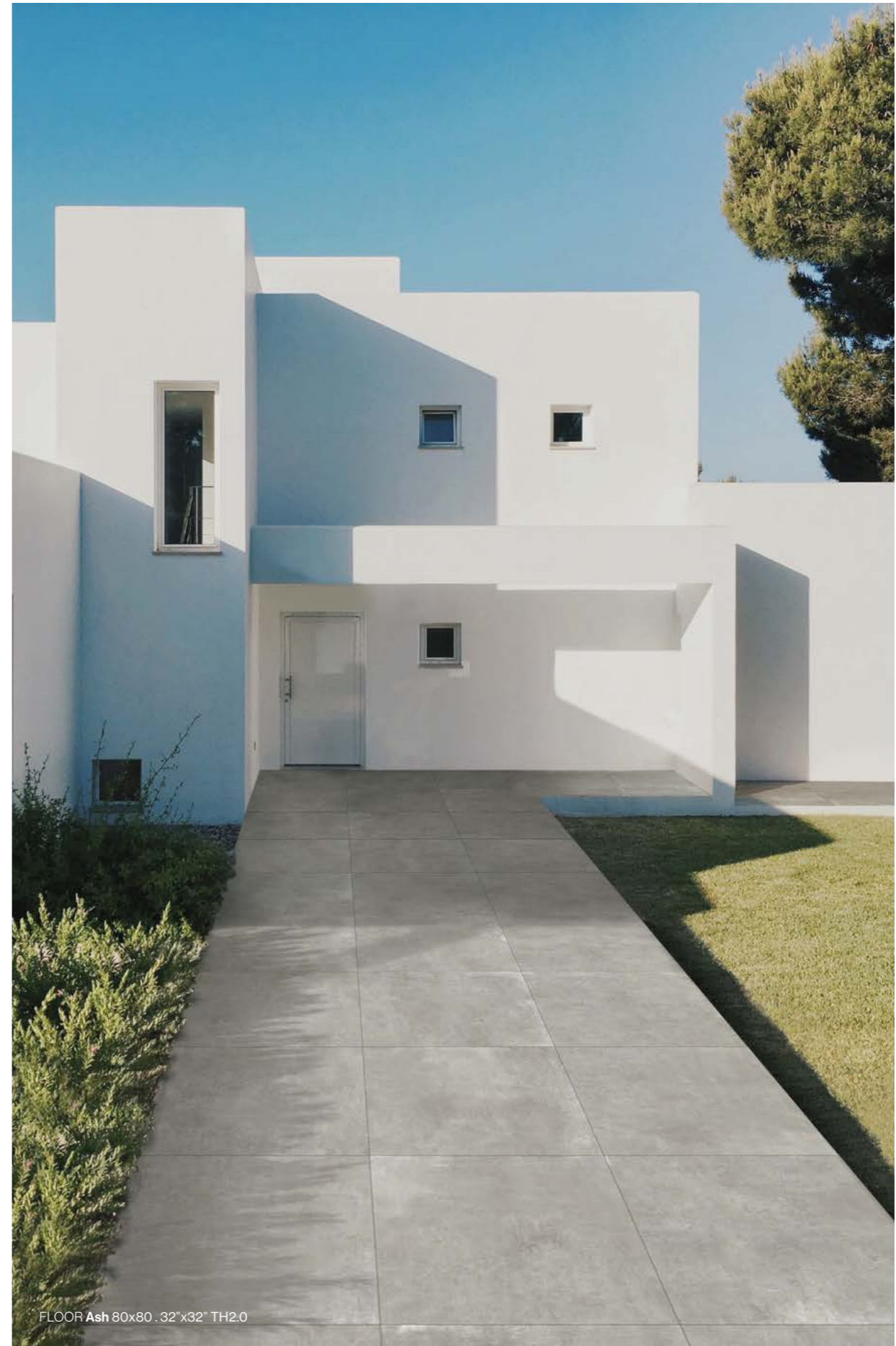

FLOOR Ash 80x80 . 32"x32" TH2.0

# Parker

Concrete that lasts

Concrete Look



Porcelain stoneware coloured in body  
Gres porcellanato colorato in massa  
Grès cérame coloré dans la masse  
Eingefärbtes Feinsteinzeug



Size Formato	Finishes Finiture	Price code sqm Codice prezzo m <sup>2</sup>	White	Ivory	Silver	Anthracite
<b>120x120</b> 48"x48" ⇒20 mm	Rectified Rettificato	165	•		•	
<b>60x120</b> 24"x48" ⇒20 mm	Rectified Rettificato	155	•	•	•	•
<b>80x80</b> 32"x32" ⇒20 mm	Rectified Rettificato	156	•	•	•	•
<b>60x60</b> 24"x24" ⇒20 mm	Rectified Rettificato	151	•		•	•

TH2.0 OUTDOOR SOLUTIONS special pieces   
TH2.0 OUTDOORSOLUTIONS pezzi speciali



FLOOR White 120x120 . 48"x48" TH2.0



TH2.0 Parker

General index

Product indexes

The Company

Collections

TH2.0  
Outdoor  
Solutions  
Marble Look  
Concrete Look  
Stone Look  
Metal Look  
Wood Look  
Special pieces

Bathroom  
furniture

Ventilated  
facades

Technical  
information

# Agathòs

Rare inspiration

Stone Look



**Porcelain stoneware coloured in body**  
 Gres porcellanato colorato in massa  
 Grès cérame coloré dans la masse  
 Eingefärbtes Feinsteinzeug



Size Formato	Finishes Finiture	Price code sqm Codice prezzo m <sup>2</sup>	White	Grey	Multicolor	Anthracite
 <b>60x120</b> 24"x48" →20 mm	Rectified Rettificato	155	●	●	●	●
 <b>60x60</b> 24"x24" →20 mm	Rectified Rettificato	151	●	●	●	●

TH2.0 OUTDOOR SOLUTIONS special pieces   
 TH2.0 OUTDOOR SOLUTIONS pezzi speciali



FLOOR Grey 60x120 . 24"x48" TH2.0



FLOOR Multicolor 60x120 . 24"x48" TH2.0

General index

Product indexes

The Company

Collections

**TH2.0 Outdoor Solutions**  
 Marble Look  
 Concrete Look  
**Stone Look**  
 Metal Look  
 Wood Look  
 Special pieces



Bathroom furniture

Ventilated facades

Technical information

# Basaltina

The designers' choice

Stone Look

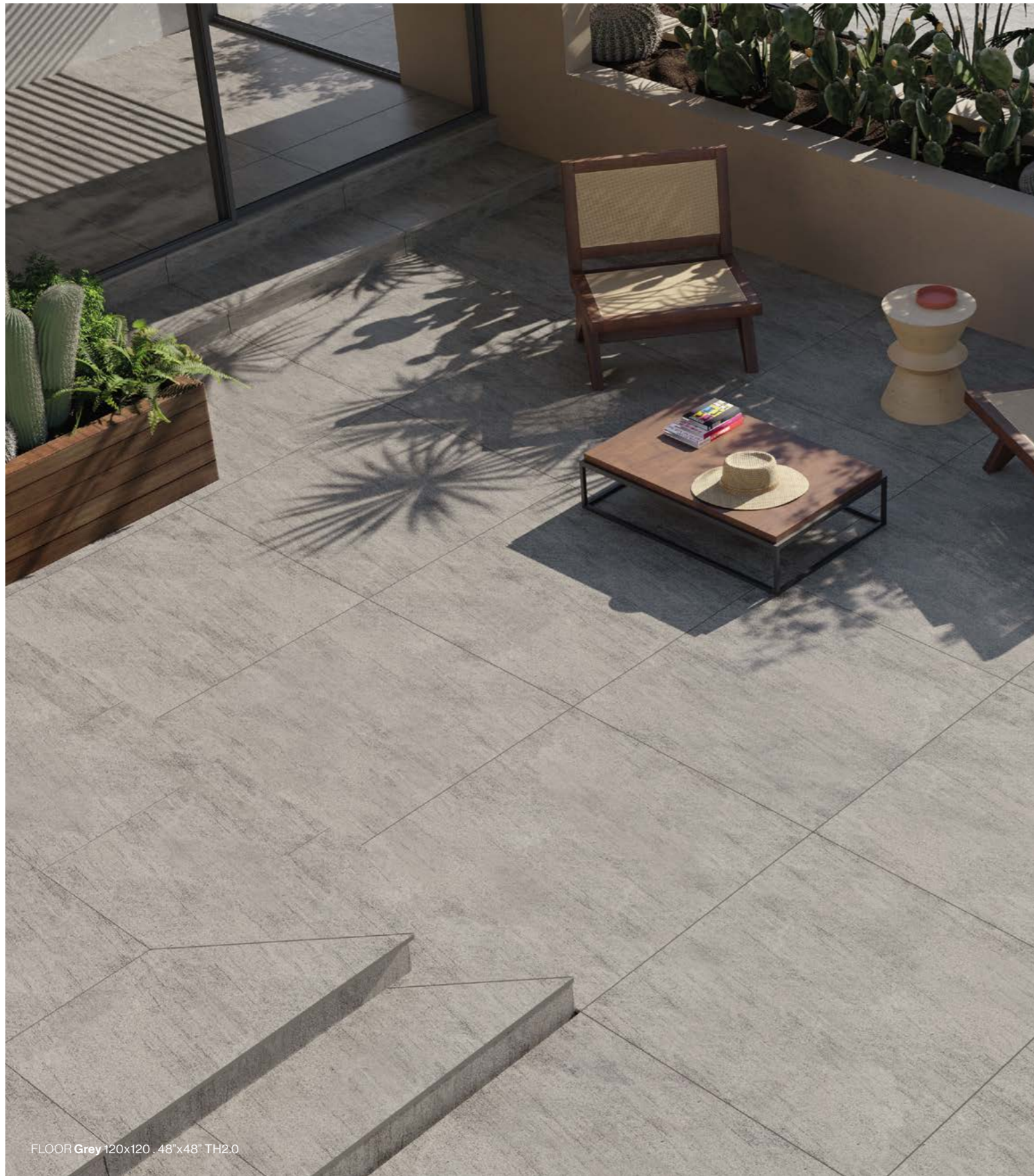

FLOOR Grey 120x120 . 48"x48" TH2.0



R11  
Rectificato  
Rettificato  
Rektifiziert

Porcelain stoneware coloured in body  
Gres porcellanato colorato in massa  
Grès cérame coloré dans la masse  
Eingefärbtes Feinsteinzeug



Grey

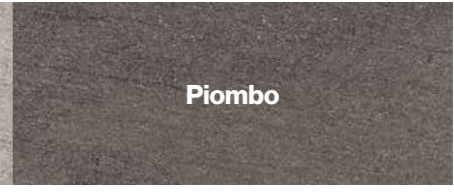

Piombo

Size Formato	Finishes Finiture	Price code sqm Codice prezzo m <sup>2</sup>		
<b>120x120</b> 48"x48" → 20 mm	Rectified Rettificato	165	•	•
<b>60x120</b> 24"x48" → 20 mm	Rectified Rettificato	155	•	•
<b>60x90</b> 24"x36" → 20 mm	Rectified Rettificato	157	•	•
<b>60x60</b> 24"x24" → 20 mm	Rectified Rettificato	151	•	•

TH2.0 OUTDOOR SOLUTIONS special pieces [↗](#)  
TH2.0 OUTDOOR SOLUTIONS pezzi speciali [↗](#)



FLOOR Piombo 60x90 . 24"x36" TH2.0



# Ceppo di Grè

Italian essential

Stone Look



R11

Rectificato

Rectifié

Rektifiziert

Porcelain stoneware coloured in body  
Gres porcellanato colorato in massa  
Grès cérame coloré dans la masse  
Eingefärbtes Feinsteinzeug

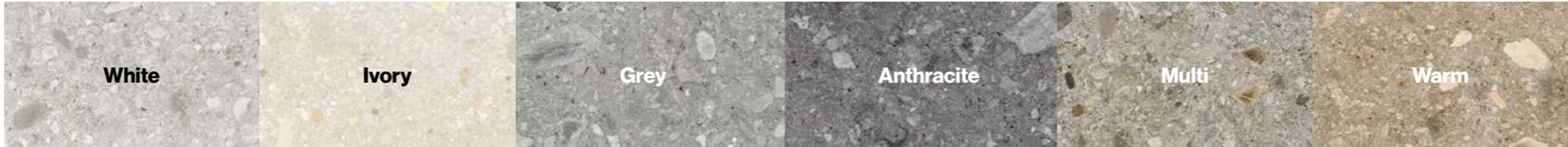

Size Formato	Finishes Finiture	Price code sqm Codice prezzo m <sup>2</sup>	White	Ivory	Grey	Anthracite	Multi	Warm
<b>120x120</b> 48"x48" ⇒20 mm	Rectified Rettificato	165	•		•			
<b>60x120</b> 24"x48" ⇒20 mm	Rectified Rettificato	155	•	•	•	•	•	•
<b>80x80</b> 32"x32" ⇒20 mm	Rectified Rettificato	156	•	•	•	•	•	•
<b>60x60</b> 24"x24" ⇒20 mm	Rectified Rettificato	151	•	•	•	•	•	•

TH2.0 OUTDOOR SOLUTIONS special pieces   
TH2.0 OUTDOORSOLUTIONS pezzi speciali



FLOOR Ivory 80x80 . 32"x32" TH2.0

General index

Product indexes

The Company

Collections

TH2.0 Outdoor Solutions

- Marble Look
- Concrete Look
- Stone Look**
- Metal Look
- Wood Look
- Special pieces



Bathroom furniture

Ventilated facades

Technical information

# Genesis

Everlasting mood

## Stone Look



Size Formato	Finishes Finiture	Price code sqm Codice prezzo m <sup>2</sup>	Dove	Cocoa	Ash	Storm
60x120 24"x48" →20 mm	Rectified Rettificato	155	•	•	•	•
60x60 24"x24" →20 mm	Rectified Rettificato	151	•	•	•	•

TH2.0 OUTDOOR SOLUTIONS special pieces [↗](#)  
 TH2.0 OUTDOOR SOLUTIONS pezzi speciali [↗](#)



FLOOR Ash 60x60 . 24"x24" TH2.0

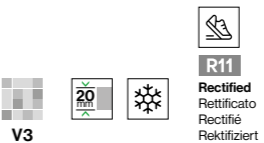

Porcelain stoneware coloured in body  
 Gres porcellanato colorato in massa  
 Grès cérame coloré dans la masse  
 Eingefärbtes Feinsteinzeug



FLOOR Storm 60x60 . 24"x24" TH2.0

General index

Product indexes

The Company

Collections

TH2.0 Outdoor Solutions

- Marble Look
- Concrete Look
- Stone Look
- Metal Look
- Wood Look
- Special pieces



Bathroom furniture

Ventilated facades

Technical information

# Heritage

Balancing aesthetics

## Stone Look



FLOOR Cornsilk 60x60 . 24"x24" TH2.0

V3

R11  
Rectificato  
Rettificato  
Rectifié  
Rektifiziert

Porcelain stoneware coloured in body  
Gres porcellanato colorato in massa  
Grès cérame coloré dans la masse  
Eingefärbtes Feinsteinzeug



Size Formato	Finishes Finiture	Price code sqm Codice prezzo m²		
<b>60x120</b> 24"x48" → 20 mm	Rectified Rettificato	155	•	•
<b>60x60</b> 24"x24" → 20 mm	Rectified Rettificato	151	•	•

TH2.0 OUTDOOR SOLUTIONS special pieces

TH2.0 OUTDOOR SOLUTIONS pezzi speciali



FLOOR Powder 60x120 . 24"x48" TH2.0

General index

Product indexes

The Company

Collections

### TH2.0 Outdoor Solutions

- Marble Look
- Concrete Look
- Stone Look
- Metal Look
- Wood Look
- Special pieces



Bathroom furniture

Ventilated facades

Technical information







# Hollstone

Indulge in quietude

Stone Look



FLOOR Opal 80x80 . 32"x32" TH2.0

**Porcelain stoneware coloured in body**  
 Gres porcellanato colorato in massa  
 Grès cérame coloré dans la masse  
 Eingefärbtes Feinsteinzeug

Milky

Butter

Opal

Size Formato	Finishes Finiture	Price code sqm Codice prezzo m²	Milky	Butter	Opal
 <b>60x120</b> 24"x48" → 20 mm	Rectified Rettificato	155	•	•	•
 <b>80x80</b> 32"x32" → 20 mm	Rectified Rettificato	156	•	•	•
 <b>60x60</b> 24"x24" → 20 mm	Rectified Rettificato	151	•	•	•

[TH2.0 OUTDOOR SOLUTIONS special pieces](#) 
  
[TH2.0 OUTDOOR SOLUTIONS pezzi speciali](#) 



FLOOR Opal 60x120 . 24"x48" TH2.0

General index

Product indexes

The Company

Collections

TH2.0 Outdoor Solutions

- Marble Look
- Concrete Look
- Stone Look**
- Metal Look
- Wood Look
- Special pieces



Bathroom furniture

Ventilated facades

Technical information

# Loop

Cloudy soft hues

Stone Look

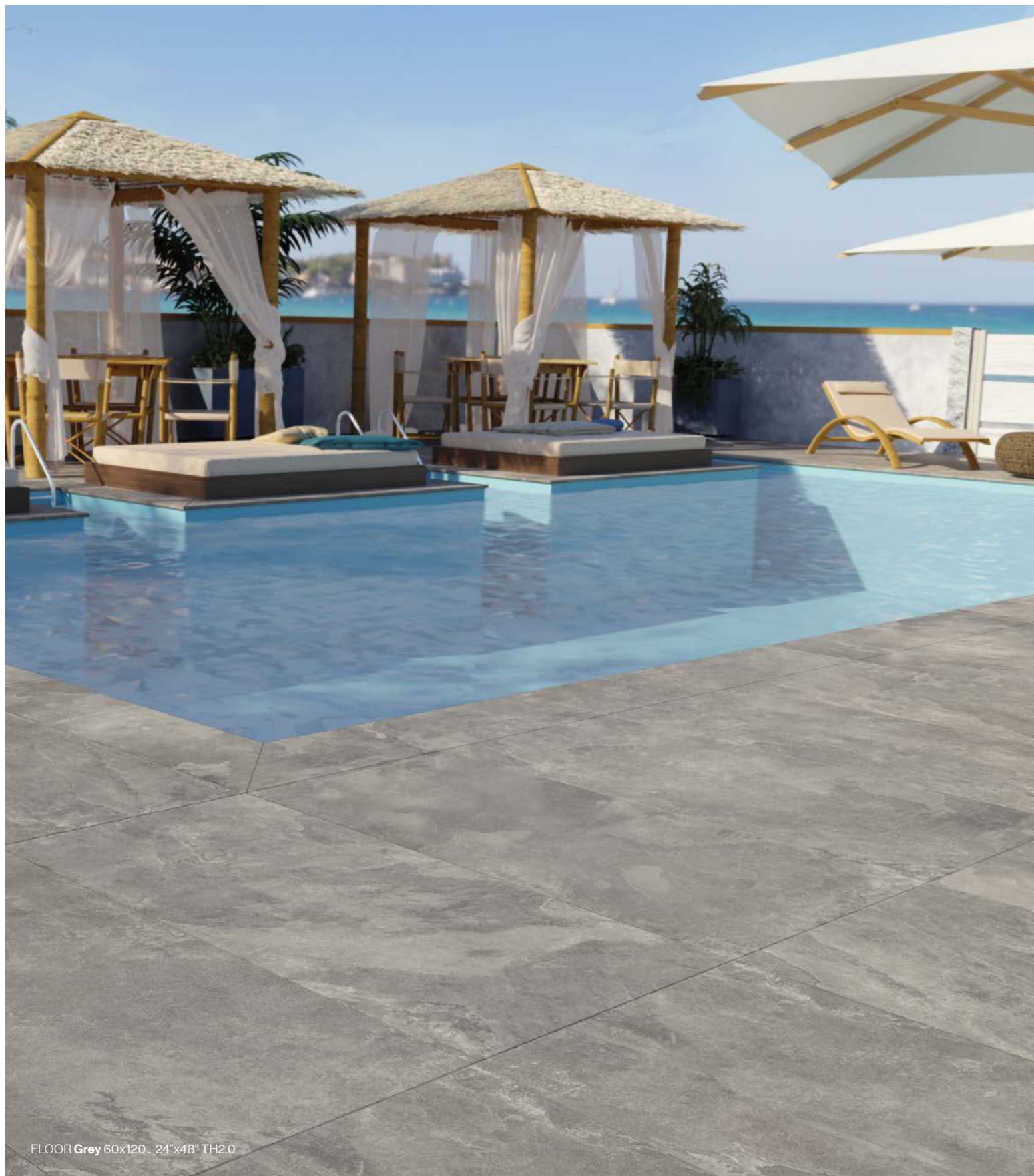

FLOOR Grey 60x120 . 24"x48" TH2.0



Porcelain stoneware coloured in body  
Gres porcellanato colorato in massa  
Grès cérame coloré dans la masse  
Eingefärbtes Feinsteinzeug

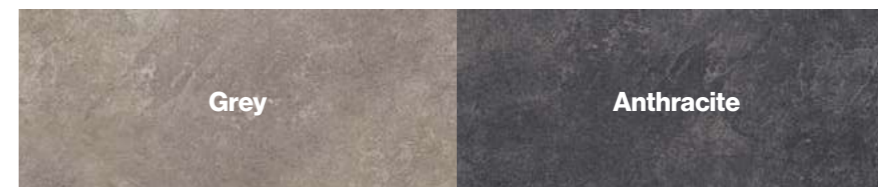

Size Formato	Finishes Finiture	Price code sqm Codice prezzo m <sup>2</sup>		
<b>120x120</b> 48"x48" → 20 mm	Rectified Rettificato	165	•	•
<b>60x120</b> 24"x48" → 20 mm	Rectified Rettificato	155	•	•
<b>60x60</b> 24"x24" → 20 mm	Rectified Rettificato	151	•	•

TH2.0 OUTDOOR SOLUTIONS special pieces [↗](#)  
TH2.0 OUTDOOR SOLUTIONS pezzi speciali [↗](#)



FLOOR Anthracite 120x120 . 48"x48" TH2.0

General index

Product indexes

The Company

Collections

TH2.0  
Outdoor  
Solutions

- Marble Look
- Concrete Look
- Stone Look
- Metal Look
- Wood Look
- Special pieces



Bathroom furniture

Ventilated facades

Technical information

# Medley

Color meets rhythm

Stone Look



FLOOR White 60x60 - 24"x24" TH2.0

V2

R11  
 Rettificato  
 Rectifié  
 Rektifiziert

Porcelain stoneware coloured in body  
 Gres porcellanato colorato in massa  
 Grès cérame coloré dans la masse  
 Eingefärbtes Feinsteinzeug

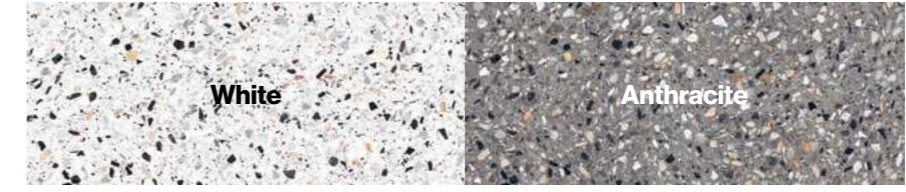

Size Formato	Finishes Finiture	Price code sqm Codice prezzo m²
 <b>80x80</b> 32"x32" → 20 mm	<b>Rectified</b> Rettificato	<b>156</b>
 <b>60x60</b> 24"x24" → 20 mm	<b>Rectified</b> Rettificato	<b>151</b>

TH2.0 OUTDOOR SOLUTIONS special pieces

TH2.0 OUTDOOR SOLUTIONS pezzi speciali



FLOOR White 80x80 - 32"x32" TH2.0

General index

Product indexes

The Company

Collections

TH2.0 Outdoor Solutions

- Marble Look
- Concrete Look
- Stone Look**
- Metal Look
- Wood Look
- Special pieces

Bathroom furniture

Ventilated facades

Technical information

# Nereidi

The embracing side of stone

Stone Look



FLOOR Cloud 60x60 . 24"x24" TH2.0

V2

R11  
 Rectificato  
 Rettificato  
 Rectifié  
 Rektifiziert

Porcelain stoneware coloured in body  
 Gres porcellanato colorato in massa  
 Grès cérame coloré dans la masse  
 Eingefärbtes Feinsteinzeug



Size Formato	Finishes Finiture	Price code sqm Codice prezzo m <sup>2</sup>	Cloud	Ecrú
 <b>60x120</b> 24"x48" → 20 mm	Rectified Rettificato	155	•	•
 <b>60x60</b> 24"x24" → 20 mm	Rectified Rettificato	151	•	•

TH2.0 OUTDOOR SOLUTIONS special pieces [☑](#)  
 TH2.0 OUTDOOR SOLUTIONS pezzi speciali [☑](#)

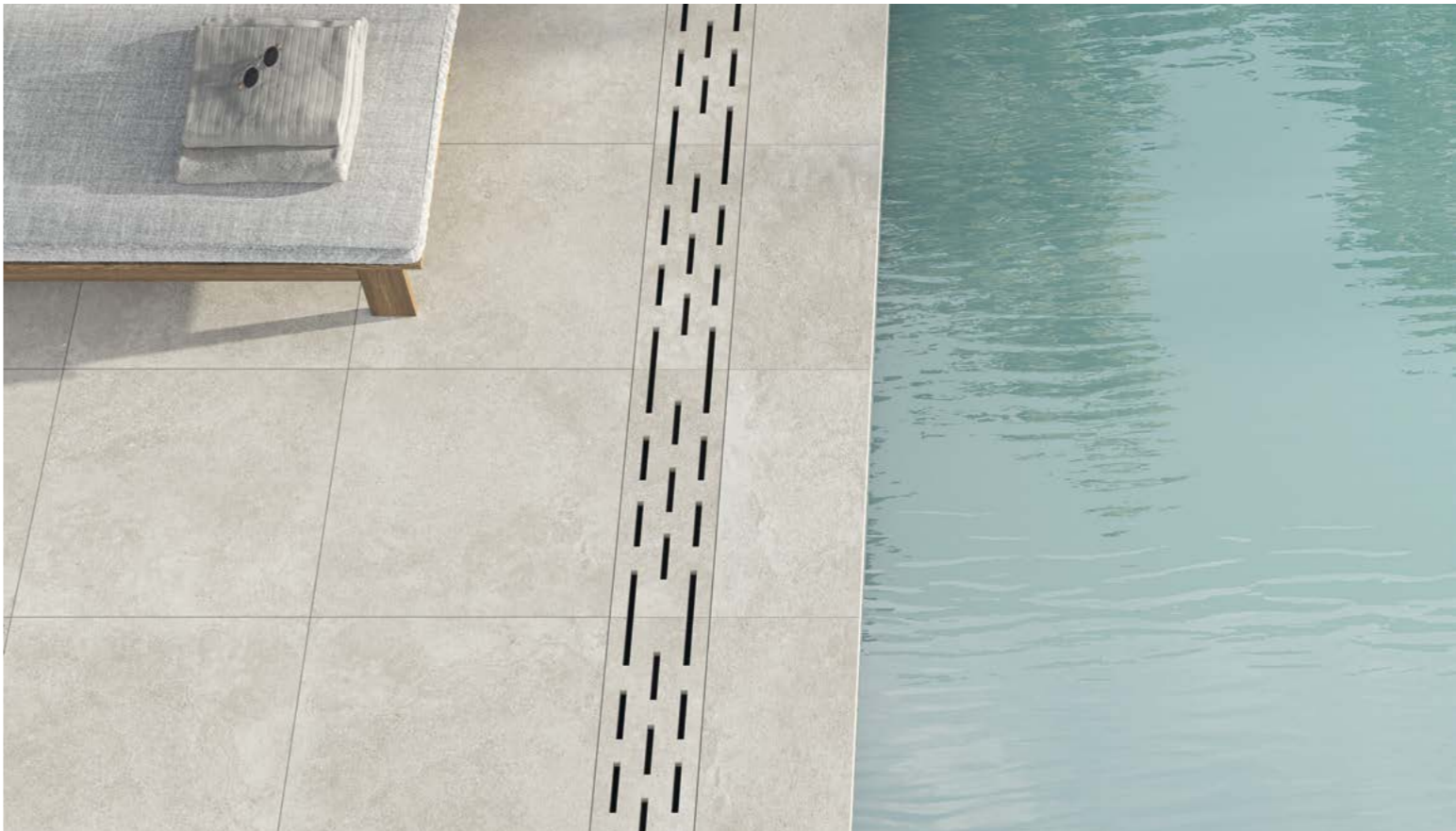

TH2.0 Nereidi

General index

Product indexes

The Company

Collections

TH2.0 Outdoor Solutions

- Marble Look
- Concrete Look
- Stone Look
- Metal Look
- Wood Look
- Special pieces



Bathroom furniture

Ventilated facades

Technical information

# Pennslate

Expect the unexpected

Stone Look

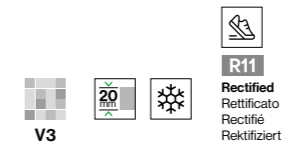

Porcelain stoneware coloured in body  
Gres porcellanato colorato in massa  
Grès cérame coloré dans la masse  
Eingefärbtes Feinsteinzeug

General index

Product indexes

The Company

Collections

TH2.0 Outdoor Solutions

- Marble Look
- Concrete Look
- Stone Look
- Metal Look
- Wood Look
- Special pieces



Bathroom furniture

Ventilated facades

Technical information



Size Formato	Finishes Finiture	Price code sqm Codice prezzo m <sup>2</sup>	Forge	Pocono	Akiba	Bali
60x120 24"x48" ±20 mm	Rectified Rettificato	155	•	•	•	•
60x90 24"x36" ±20 mm	Rectified Rettificato	157	•	•	•	•
60x60 24"x24" ±20 mm	Rectified Rettificato	151	•	•	•	•

TH2.0 OUTDOOR SOLUTIONS special pieces [↗](#)  
TH2.0 OUTDOOR SOLUTIONS pezzi speciali [↗](#)



FLOOR Akiba 60x120 . 24"x48" TH2.0

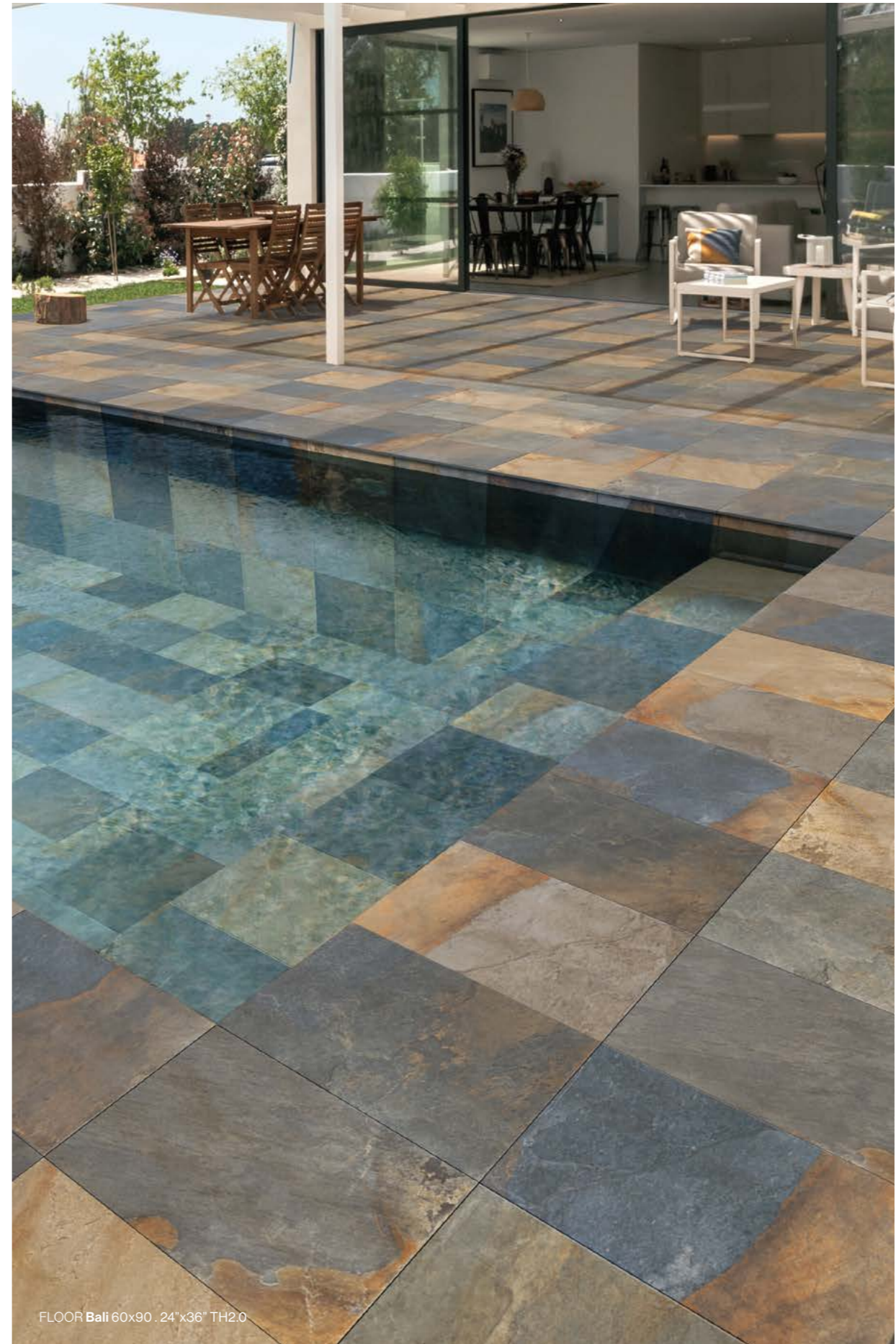

FLOOR Bali 60x90 . 24"x36" TH2.0

# Pietra di Vals

Compelling and captivating presence

Stone Look

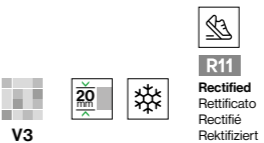

Porcelain stoneware coloured in body  
Gres porcellanato colorato in massa  
Grès cérame coloré dans la masse  
Eingefärbtes Feinsteinzeug

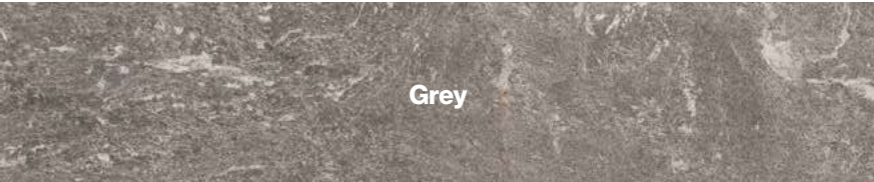

FLOOR Grey 80x80 . 32"x32" TH2.0

Size Formato	Finishes Finiture	Price code sqm Codice prezzo m <sup>2</sup>
<b>60x120</b> 24"x48" → 20 mm	Rectified Rettificato	155
<b>60x90</b> 24"x36" → 20 mm	Rectified Rettificato	157
<b>80x80</b> 32"x32" → 20 mm	Rectified Rettificato	156
<b>60x60</b> 24"x24" → 20 mm	Rectified Rettificato	151

TH2.0 OUTDOOR SOLUTIONS special pieces   
TH2.0 OUTDOORSOLUTIONS pezzi speciali

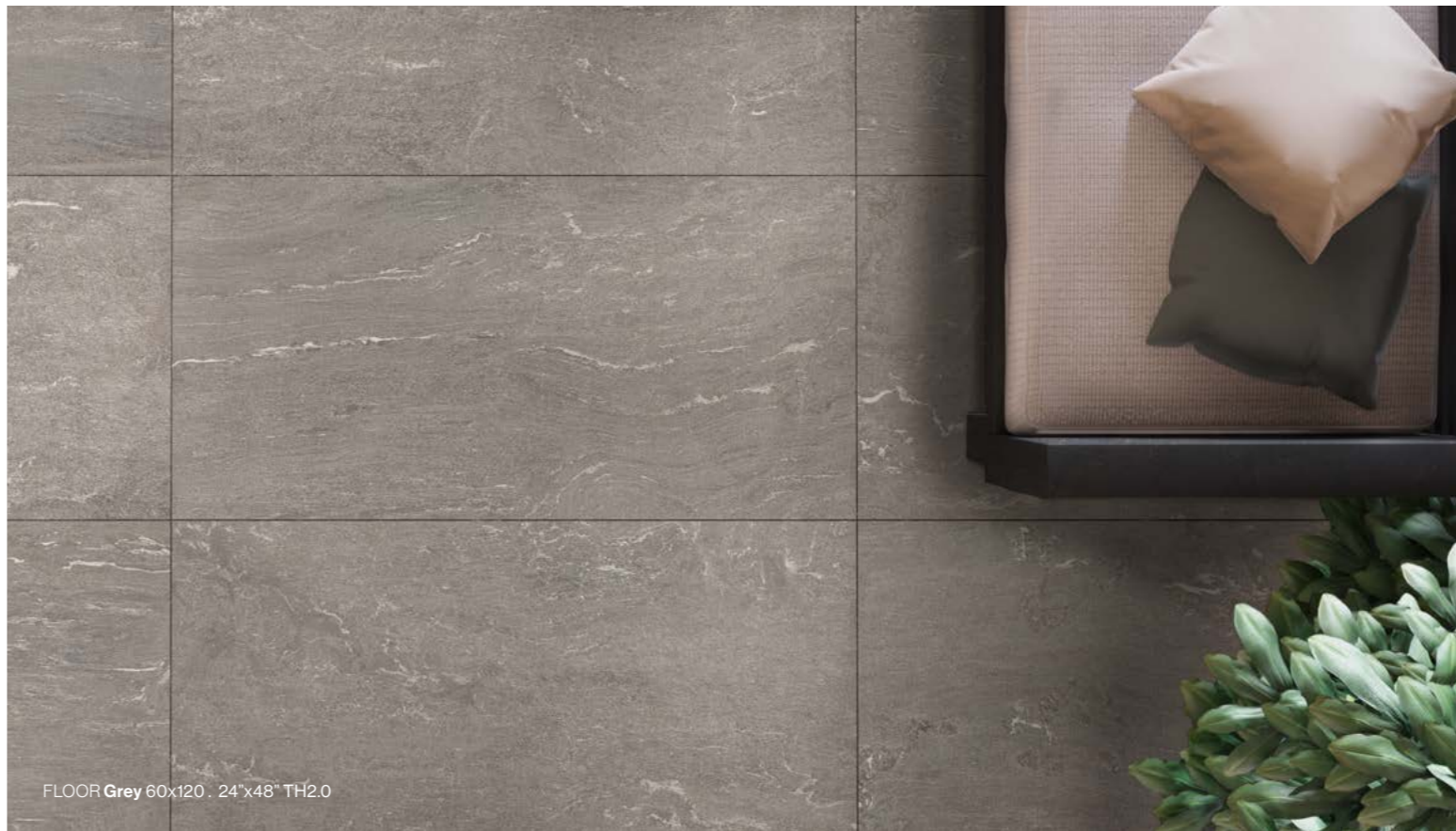

FLOOR Grey 60x120 . 24"x48" TH2.0

General index

Product indexes

The Company

Collections

TH2.0  
Outdoor  
Solutions

- Marble Look
- Concrete Look
- Stone Look**
- Metal Look
- Wood Look
- Special pieces



Bathroom furniture

Ventilated facades

Technical information

# Rushmore

Soothing shades, pure calm

### Stone Look



Size Formato	Finishes Finiture	Price code sqm Codice prezzo m <sup>2</sup>	Sand	Beige	Grey	Anthracite
60x120 24"x48" ⇒20 mm	Rectified Rettificato	155	•	•	•	•
60x90 24"x36" ⇒20 mm	Rectified Rettificato	157	•	•	•	•
60x60 24"x24" ⇒20 mm	Rectified Rettificato	151	•	•	•	•

TH2.0 OUTDOOR SOLUTIONS special pieces    
 TH2.0 OUTDOOR SOLUTIONS pezzi speciali

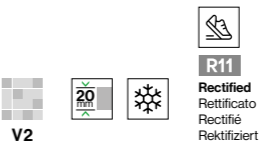

Porcelain stoneware coloured in body  
Gres porcellanato colorato in massa  
Grès cérame coloré dans la masse  
Eingefärbtes Feinsteinzeug



FLOOR Beige 60x120 . 24"x48" TH2.0



TH2.0 Rushmore

General index

Product indexes

The Company

Collections

TH2.0 Outdoor Solutions

- Marble Look
- Concrete Look
- Stone Look
- Metal Look
- Wood Look
- Special pieces



Bathroom furniture

Ventilated facades

Technical information

# Spark

Precious shades

Stone Look



FLOOR Grey 60x120 . 24"x48" TH2.0

V3

R11  
 Rettificato  
 Rettificato  
 Rectifié  
 Rektifiziert

Porcelain stoneware coloured in body  
 Gres porcellanato colorato in massa  
 Grès cérame coloré dans la masse  
 Eingefärbtes Feinsteinzeug

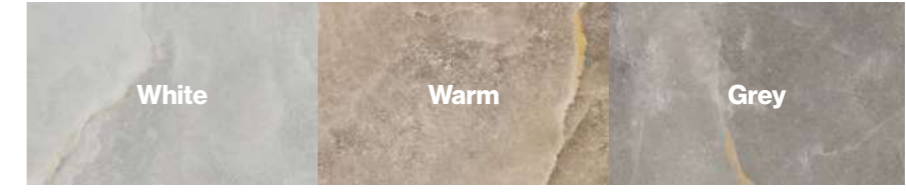

Size Formato	Finishes Finiture	Price code sqm Codice prezzo m <sup>2</sup>	White	Warm	Grey
 <b>60x120</b> 24"x48" → 20 mm	Rectified Rettificato	155	•	•	•
 <b>60x60</b> 24"x24" → 20 mm	Rectified Rettificato	151	•	•	•

TH2.0 OUTDOOR SOLUTIONS special pieces [↗](#)  
 TH2.0 OUTDOOR SOLUTIONS pezzi speciali [↗](#)



TH2.0 Spark

General index

Product indexes

The Company

Collections

TH2.0 Outdoor Solutions

- Marble Look
- Concrete Look
- Stone Look**
- Metal Look
- Wood Look
- Special pieces



Bathroom furniture

Ventilated facades

Technical information



# Sunstone

Essential naturality

## Stone Look



Size Formato	Finishes Finiture	Price code sqm Codice prezzo m <sup>2</sup>	Freya	Aloh	Loki	Groa
<b>120x120</b> 48"x48" ±20 mm	Rectified Rettificato	165	•		•	
<b>60x120</b> 24"x48" ±20 mm	Rectified Rettificato	155	•	•	•	•
<b>60x90</b> 24"x36" ±20 mm	Rectified Rettificato	157	•	•	•	•
<b>60x60</b> 24"x24" ±20 mm	Rectified Rettificato	151	•	•	•	•

TH2.0 OUTDOOR SOLUTIONS special pieces

TH2.0 OUTDOORSOLUTIONS pezzi speciali



FLOOR Loki 60x90 . 24"x36" TH2.0



FLOOR Freya 120x120 . 48"x48" TH2.0

V3

20

R11  
Rectificato  
Rettifié  
Rektifiziert

Porcelain stoneware coloured in body  
Gres porcellanato colorato in massa  
Grès cérame coloré dans la masse  
Eingefärbtes Feinsteinzeug

General index

Product indexes

The Company

Collections

TH2.0  
Outdoor  
Solutions

- Marble Look
- Concrete Look
- Stone Look
- Metal Look
- Wood Look
- Special pieces



Bathroom furniture

Ventilated facades

Technical information

# Urano

Powerful emotion

## Stone Look



**Porcelain stoneware coloured in body**  
 Gres porcellanato colorato in massa  
 Grès cérame coloré dans la masse  
 Eingefärbtes Feinsteinzeug



FLOOR Grigio 60x90 - 24"x36" TH2.0

Size Formato	Finishes Finiture	Price code sqm Codice prezzo m <sup>2</sup>
<b>60x120</b> 24"x48" → 20 mm	Rectified Rettificato	155
<b>60x90</b> 24"x36" → 20 mm	Rectified Rettificato	157
<b>80x80</b> 32"x32" → 20 mm	Rectified Rettificato	156
<b>60x60</b> 24"x24" → 20 mm	Rectified Rettificato	151

TH2.0 OUTDOOR SOLUTIONS special pieces   
 TH2.0 OUTDOORSOLUTIONS pezzi speciali



FLOOR Grigio 60x120 - 24"x48" TH2.0

General index

Product indexes

The Company

Collections

### TH2.0 Outdoor Solutions

- Marble Look
- Concrete Look
- Stone Look**
- Metal Look
- Wood Look
- Special pieces



Bathroom furniture

Ventilated facades

Technical information

# Wonder

Comfortably warm

## Stone Look



Size Formato	Finishes Finiture	Price code sqm Codice prezzo m²	Bright	Sleet	Dunes	Shade	Brave
60x120 24"x48" ⇒ 20 mm	Rectified Rettificato	155	•	•	•	•	•
60x90 24"x36" ⇒ 20 mm	Rectified Rettificato	157	•	•	•	•	•
60x60 24"x24" ⇒ 20 mm	Rectified Rettificato	151	•	•	•	•	•

TH2.0 OUTDOOR SOLUTIONS special pieces [↗](#)

TH2.0 OUTDOOR SOLUTIONS pezzi speciali [↗](#)



FLOOR Shade 60x120 . 24"x48" TH2.0

V3

20

R11  
Rectificato  
Rettificato  
Rektifiziert

Porcelain stoneware coloured in body  
Gres porcellanato colorato in massa  
Grès cérame coloré dans la masse  
Eingefärbtes Feinsteinzeug

General index

Product indexes

The Company

Collections

TH2.0  
Outdoor  
Solutions

- Marble Look
- Concrete Look
- Stone Look**
- Metal Look
- Wood Look
- Special pieces



Bathroom furniture

Ventilated facades

Technical information

# Flatiron

Industrial spirit

Metal Look



R11  
Rectified  
Rettificato  
Rektifié  
Rektifiziert

Porcelain stoneware coloured in body  
Gres porcellanato colorato in massa  
Grès cérame coloré dans la masse  
Eingefärbtes Feinsteinzeug



Size Formato	Finishes Finiture	Price code sqm Codice prezzo m <sup>2</sup>	White	Rust	Black
<b>60x120</b> 24"x48" → 20 mm	Rectified Rettificato	155	•	•	•
<b>80x80</b> 32"x32" → 20 mm	Rectified Rettificato	156	•	•	•
<b>60x60</b> 24"x24" → 20 mm	Rectified Rettificato	151	•	•	•

TH2.0 OUTDOOR SOLUTIONS special pieces [↗](#)  
TH2.0 OUTDOOR SOLUTIONS pezzi speciali [↗](#)



FLOOR White 80x80 . 32" x32" TH2.0



FLOOR Rust 60x120 . 24" x48" TH2.0

General index

Product indexes

The Company

Collections

TH2.0  
Outdoor  
Solutions

- Marble Look
- Concrete Look
- Stone Look
- Metal Look**
- Wood Look
- Special pieces



Bathroom furniture

Ventilated facades

Technical information

# Magnetic

The sophisticated side of metal

Metal Look



Porcelain stoneware coloured in body  
Gres porcellanato colorato in massa  
Grès cérame coloré dans la masse  
Eingefärbtes Feinsteinzeug



Size Formato	Finishes Finiture	Price code sqm Codice prezzo m <sup>2</sup>	Grey	Dark Grey	Bronze	Black
60x120 24"x48" ⇒20 mm	Rectified Rettificato	155	•	•	•	•
80x80 32"x32" ⇒20 mm	Rectified Rettificato	156	•			•
60x60 24"x24" ⇒20 mm	Rectified Rettificato	151	•	•	•	•

TH2.0 OUTDOOR SOLUTIONS special pieces

TH2.0 OUTDOOR SOLUTIONS pezzi speciali



FLOOR Bronze 60x60 . 24"x24" TH2.0

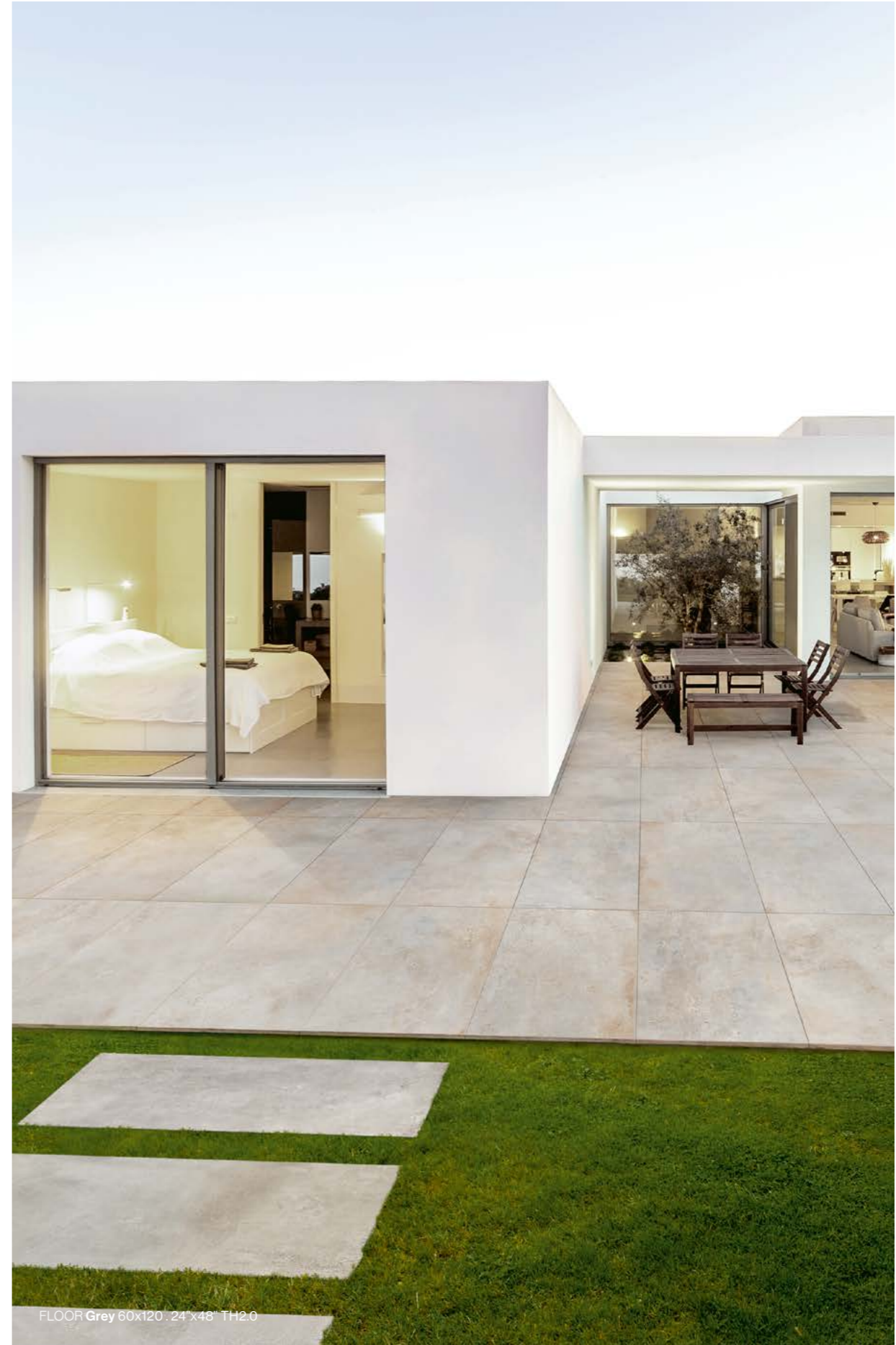

FLOOR Grey 60x120 . 24"x48" TH2.0

General index

Product indexes

The Company

Collections

TH2.0  
Outdoor  
Solutions

- Marble Look
- Concrete Look
- Stone Look
- Metal Look**
- Wood Look
- Special pieces



Bathroom furniture

Ventilated facades

Technical information

# Padouk

Reimagined wood style

Wood Look



Size Formato	Finishes Finiture	Price code sqm Codice prezzo m <sup>2</sup>	White	Beige	Nut	Grey
<b>60x120</b> 24"x48" ⇒20 mm	Rectified Rettificato	155	•	•	•	•
<b>30x120</b> 12"x48" ⇒20 mm	Rectified Rettificato	156	•	•	•	•
<b>60x60</b> 24"x24" ⇒20 mm	Rectified Rettificato	151	•	•	•	•

TH2.0 OUTDOOR SOLUTIONS special pieces [↗](#)  
TH2.0 OUTDOOR SOLUTIONS pezzi speciali [↗](#)



FLOOR Beige 30x120 . 12"x48" TH2.0

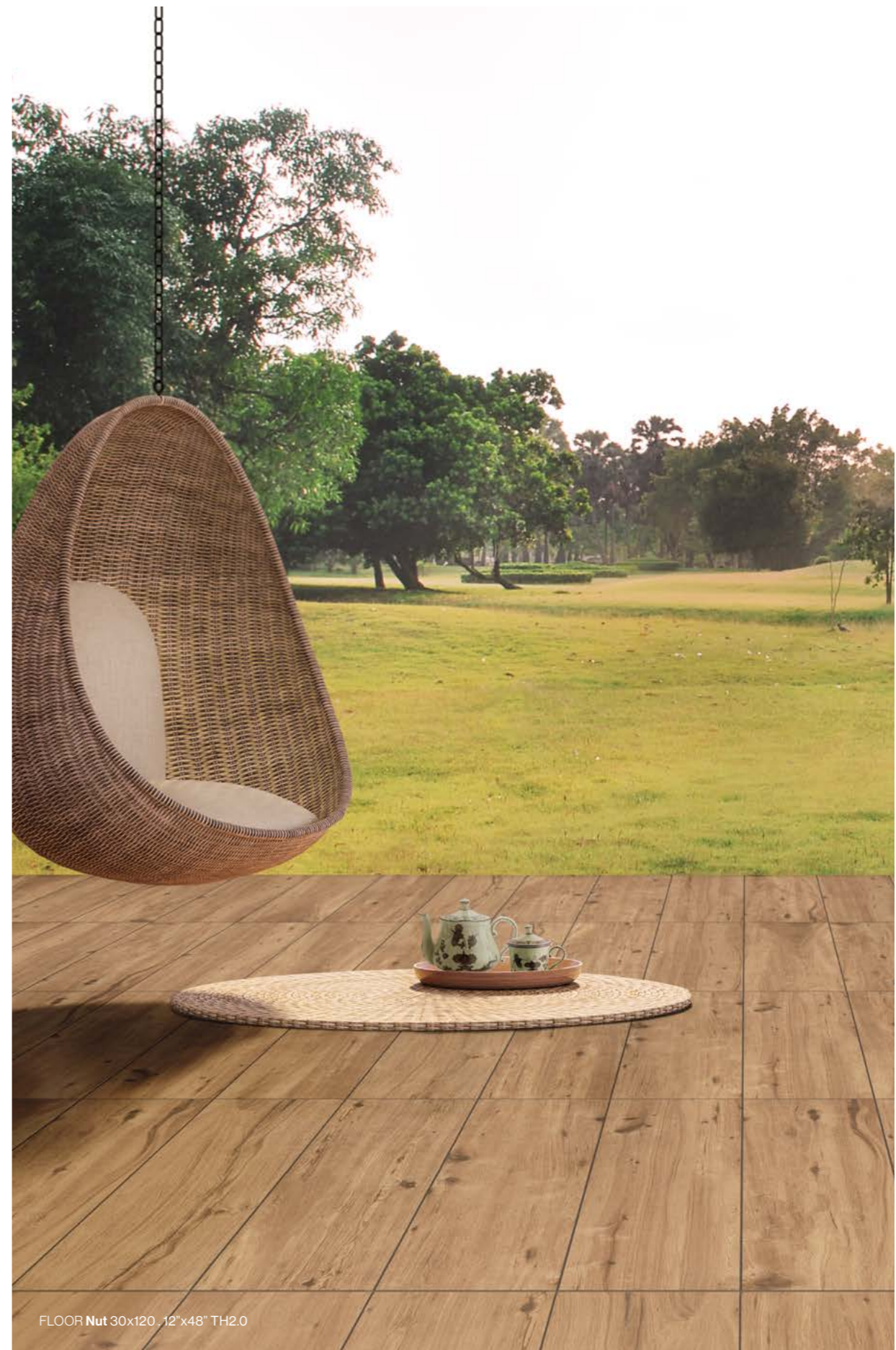

FLOOR Nut 30x120 . 12"x48" TH2.0



**Porcelain stoneware coloured in body**  
Gres porcellanato colorato in massa  
Grès cérame coloré dans la masse  
Eingefärbtes Feinsteinzeug

General index

Product indexes

The Company

Collections

**TH2.0  
Outdoor  
Solutions**

Marble Look  
Concrete Look  
Stone Look  
Metal Look  
**Wood Look**  
Special pieces



Bathroom furniture

Ventilated facades

Technical information

# Robur

Resilient by nature

Wood Look

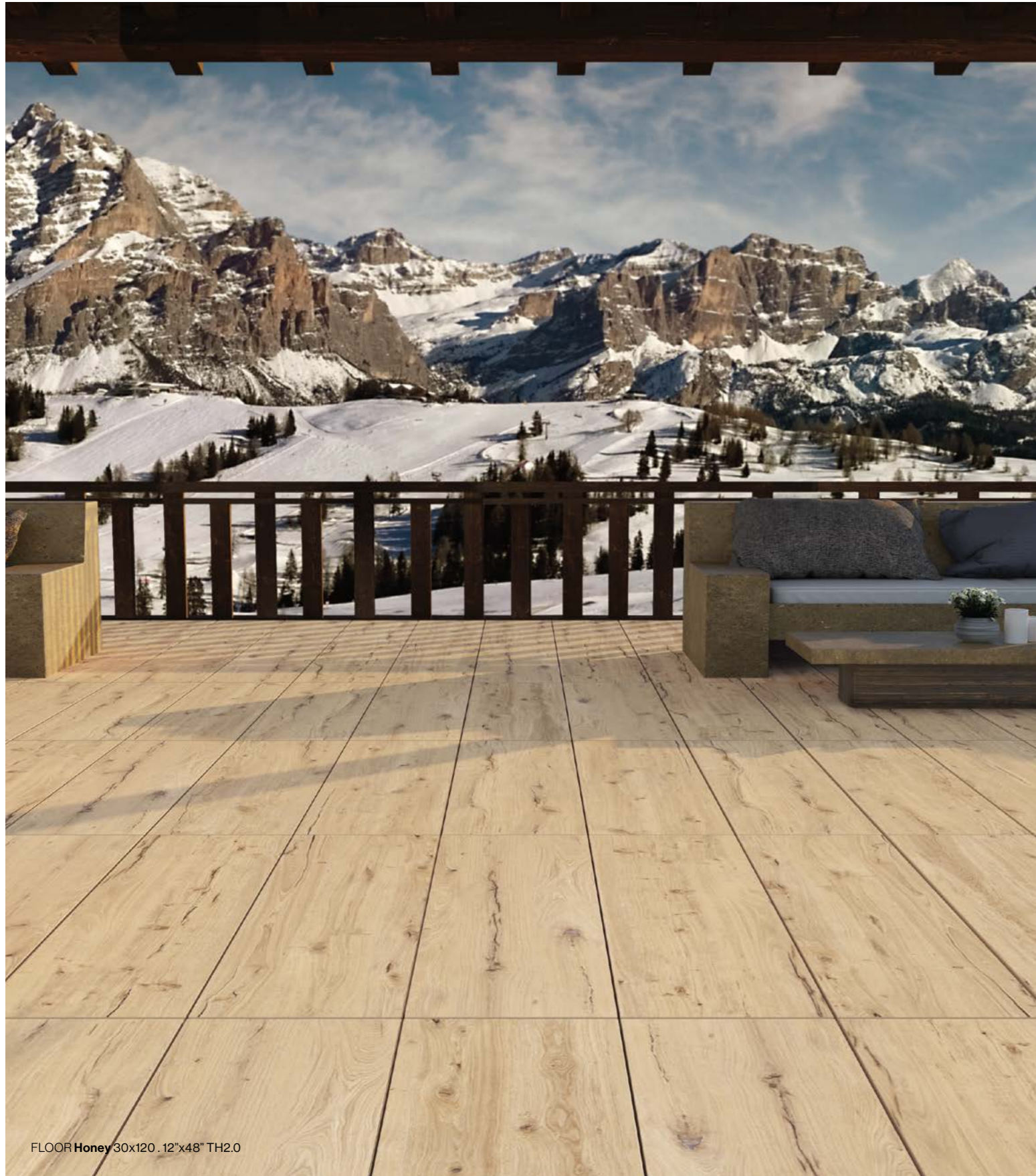

FLOOR Honey 30x120 . 12"x48" TH2.0

V2

R11  
Rectificato  
Rectifié  
Rektifiziert

Porcelain stoneware coloured in body  
Gres porcellanato colorato in massa  
Grès cérame coloré dans la masse  
Eingefärbtes Feinsteinzeug

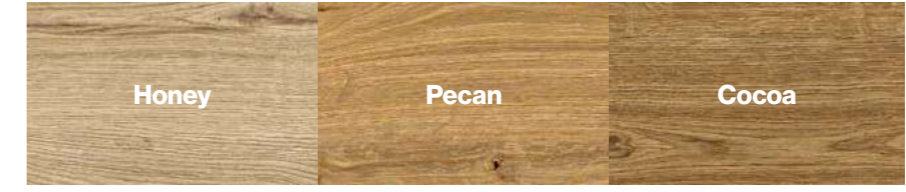

Size Formato	Finishes Finiture	Price code sqm Codice prezzo m <sup>2</sup>
 <b>30x120</b> 12"x48" ⇒ 20 mm	<b>Rectified</b> Rettificato	<b>156</b>

TH2.0 OUTDOOR SOLUTIONS special pieces [🔗](#)  
TH2.0 OUTDOOR SOLUTIONS pezzi speciali [🔗](#)



FLOOR Pecan 30x120 . 12"x48" TH2.0

General index

Product indexes

The Company

Collections

TH2.0  
Outdoor  
Solutions

- Marble Look
- Concrete Look
- Stone Look
- Metal Look
- Wood Look**
- Special pieces



Bathroom furniture

Ventilated facades

Technical information

# Woodbreak

Cozy design feelings

### Wood Look



Size Formato	Finishes Finiture	Price code sqm Codice prezzo m <sup>2</sup>
<b>30x120</b> 12"x48" → 20 mm	<b>Rectified</b> Rettificato	<b>156</b>

TH2.0 OUTDOORSOLUTIONS special pieces

TH2.0 OUTDOORSOLUTIONS pezzi speciali

**R11**  
 Rectified  
 Rettificato  
 Rectifié  
 Rektifiziert

**Porcelain stoneware coloured in body**  
 Gres porcellanato colorato in massa  
 Grès cérame coloré dans la masse  
 Eingefärbtes Feinsteinzeug



FLOOR Oak 30x120 . 12"x48" TH2.0



FLOOR Hemlock 30x120 . 12"x48" TH2.0

General index

Product indexes

The Company

Collections

TH2.0 Outdoor Solutions

- Marble Look
- Concrete Look
- Stone Look
- Metal Look
- Wood Look**
- Special pieces



Bathroom furniture

Ventilated facades

Technical information



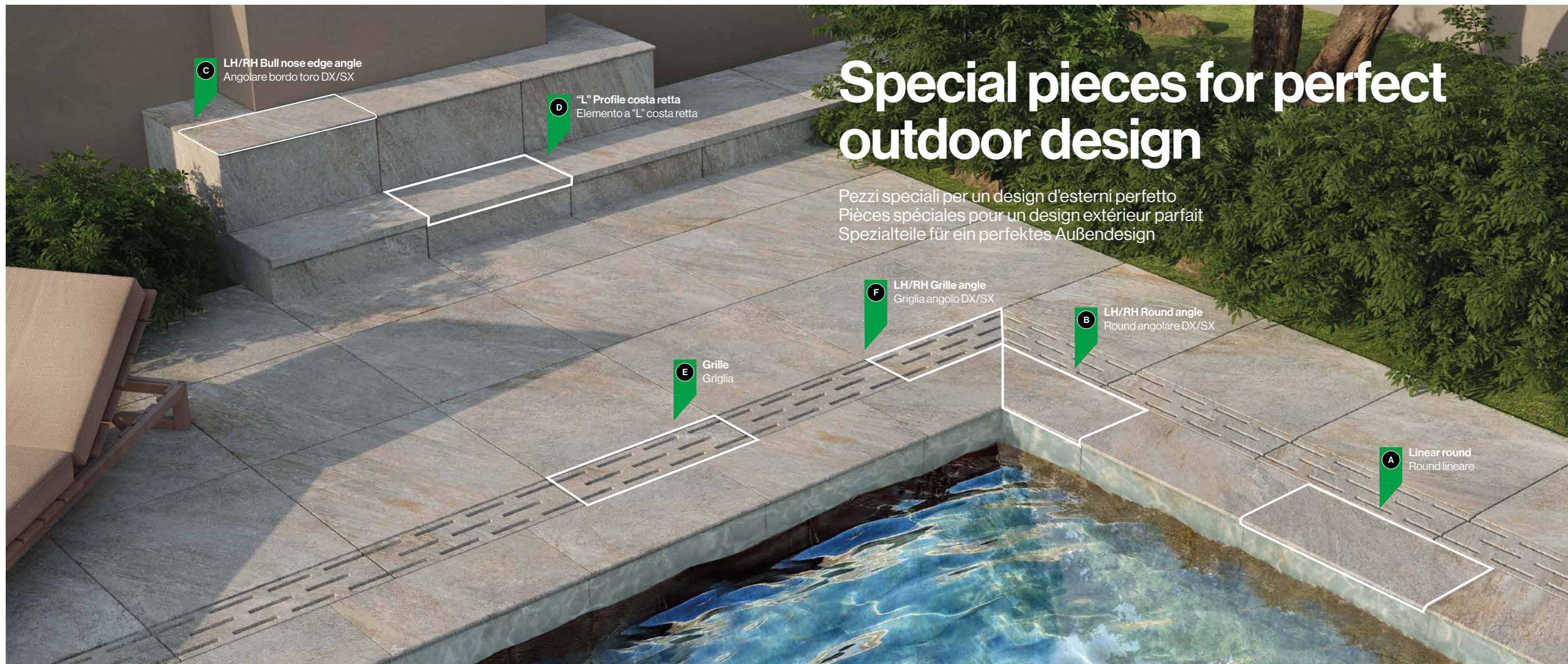

# Special pieces for perfect outdoor design

Pezzi speciali per un design d'esterni perfetto  
Pièces spéciales pour un design extérieur parfait  
Spezialteile für ein perfektes Außendesign

**C** LH/RH Bull nose edge angle  
Angolare bordo toro DX/SX

**D** "L" Profile costa retta  
Elemento a "L" costa retta

**F** LH/RH Grille angle  
Griglia angolo DX/SX

**B** LH/RH Round angle  
Round angolare DX/SX

**E** Grille  
Griglia

**A** Linear round  
Round lineare

**A**

**Linear round**  
Round lineare

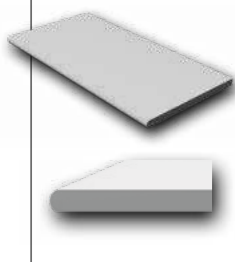

**B**

**LH/RH Round angle**  
Round angolare DX/SX

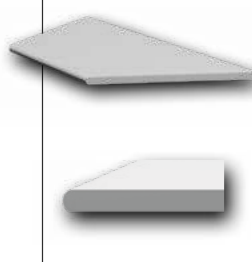

**C**

**LH/RH Bull nose edge angle**  
Angolare bordo toro DX/SX

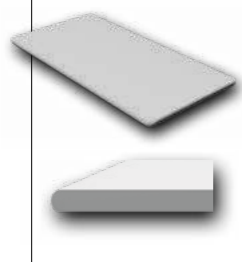

**D**

**"L" Profile costa retta**  
Elemento a "L" costa retta

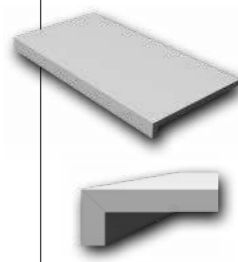

**E**

**Grille**  
Griglia

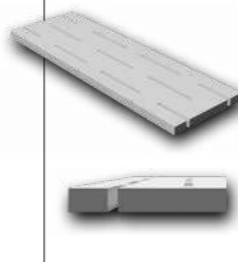

**F**

**LH/RH Grille angle**  
Griglia angolo DX/SX

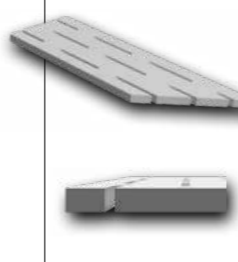

**Special pieces available for all series.**  
**The round edge has the natural color of the body.**  
**It does not match the color of the glazed surface.**

Pezzi speciali disponibili su tutte le serie.  
Il bordo arrotondato è del colore naturale del supporto, di conseguenza differente dal colore della superficie smaltata del prodotto.

Pièces spéciales disponibles pour toutes les séries.  
Le bord arrondi présente la couleur du support du produit, donc il est différent de la couleur de la surface émaillée.

Formteile für alle Serien erhältlich.  
Bei Sonderteilen für den Schwimmbadrand ist die abgerundete Kante die in der Farbe des Scherbens und damit unterscheidet sich die bearbeitete Kante von der dekorierten Oberfläche der Platten.

General index

Product indexes

The Company

Collections

**TH2.0 Outdoor Solutions**

Marble Look  
Concrete Look  
Stone Look  
Metal Look  
Wood Look  
Special pieces

Bathroom furniture

Ventilated facades

Technical information

# TH2.0 OUTDOOR SOLUTIONS

**Special pieces**  
Pezzi speciali. Pièces spéciales. Formteile.

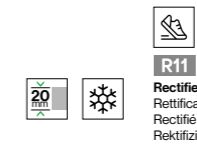

**Porcelain stoneware coloured in body**  
Gres porcellanato colorato in massa  
Grès cérame coloré dans la masse  
Eingefärbtes Feinsteinzeug

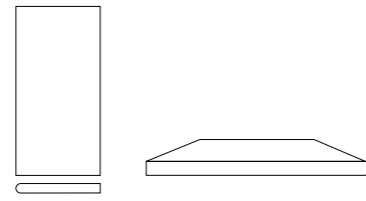

**A** LINEAR ROUND  
ROUND LINEARE

<b>30x60</b> 12"x24" ±20 mm	<b>30x120</b> 12"x48" ±20 mm	<b>40x80</b> 16"x32" ±20 mm	<b>60x90</b> 24"x36" ±20 mm	<b>60x120</b> 24"x48" ±20 mm
-----------------------------------	------------------------------------	-----------------------------------	-----------------------------------	------------------------------------

Rectified  
Rettificato

Price code / pc.  
Codice prezzo / pz.

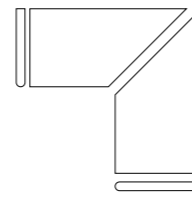

**B** LH/RH ROUND ANGLE  
ROUND ANGOLARE DX/SX

<b>30x60</b> 12"x24" ±20 mm	<b>30x120</b> 12"x48" ±20 mm	<b>40x80</b> 16"x32" ±20 mm	<b>60x90</b> 24"x36" ±20 mm	<b>60x120</b> 24"x48" ±20 mm
-----------------------------------	------------------------------------	-----------------------------------	-----------------------------------	------------------------------------

Rectified  
Rettificato

Price code / pc.  
Codice prezzo / pz.

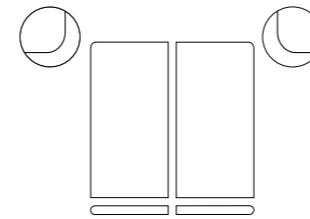

**C** LH/RH BULL NOSE EDGE ANGLE  
ANGOLARE BORDO TORO DX/SX

<b>30x60</b> 12"x24" ±20 mm	<b>30x120</b> 12"x48" ±20 mm	<b>40x80</b> 16"x32" ±20 mm	<b>60x90</b> 24"x36" ±20 mm	<b>60x120</b> 24"x48" ±20 mm
-----------------------------------	------------------------------------	-----------------------------------	-----------------------------------	------------------------------------

Rectified  
Rettificato

Price code / pc.  
Codice prezzo / pz.

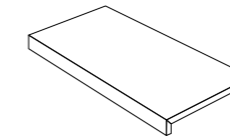

**D** "L" PROFILE COSTA RETTA  
ELEMENTO A "L" COSTA RETTA

<b>30x60x5</b> 12"x24"x2" ±20 mm	<b>30x90x5</b> 12"x36"x2" ±20 mm	<b>40x80x5</b> 16"x32"x2" ±20 mm	<b>30x120x5</b> 12"x48"x2" ±20 mm
--	--	--	---

Rectified  
Rettificato

Price code / pc.  
Codice prezzo / pz.

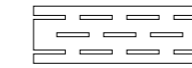

**E** GRILLE  
GRIGLIA

<b>20x60</b> 8"x24" ±20 mm	<b>20x80</b> 8"x32" ±20 mm	<b>20x90</b> 8"x36" ±20 mm
----------------------------------	----------------------------------	----------------------------------

Rectified  
Rettificato

Price code / pc.  
Codice prezzo / pz.

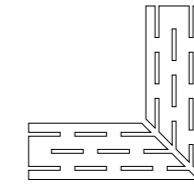

**F** LH/RH GRILLE ANGLE  
GRIGLIA ANGOLO DX/SX

<b>20x60</b> 8"x24" ±20 mm	<b>20x80</b> 8"x32" ±20 mm	<b>20x90</b> 8"x36" ±20 mm
----------------------------------	----------------------------------	----------------------------------

Rectified  
Rettificato

Price code / pc.  
Codice prezzo / pz.

LOOK	Model	A					B					C					D				E			F			
		30x60	30x120	40x80	60x90	60x120	30x60	30x120	40x80	60x90	60x120	30x60	30x120	40x80	60x90	60x120	30x60x5	30x90x5	40x80x5	30x120x5	20x60	20x80	20x90	20x60	20x80	20x90	
MARBLE LOOK	Calacatta	152	171			177	157	179			179	172	183			183	165			183	162				166		
	Navona Soft	152		166	167		157		172	173		172		178	179		165	178	176		162	174	176	166	179	180	
	Navona Vein	152	171		167	177	157	179		173	179	172	183		179	183	165	178		183	162		176	166		180	
CONCRETE LOOK	Brera	152	171			177	157	179			179	172	183			183	165			183	162				166		
	Loft	152	171	166		177	157	179	172		179	172	183	178		183	165		176	183	162	174		166	179		
	Parker	152	171	166		177	157	179	172		179	172	183	178		183	165		176	183	162	174		166	179		
METAL LOOK	Flatiron	152	171	166		177	157	179	172		179	172	183	178		183	165		176	183	162	174		166	179		
	Magnetic	152	171	166		177	157	179	172		179	172	183	178		183	165		176	183	162	174		166	179		
WOOD LOOK	Padouk	152	171			177	157	179			179	172	183			183	165			183	162				166		
	Robur		171					179					183							183							
	Woodbreak		171					179					183							183							

General  
index

Product  
indexes

The  
Company

Collections

**TH2.0  
Outdoor  
Solutions**

Marble Look  
Concrete Look  
Stone Look  
Metal Look  
Wood Look  
Special pieces

Bathroom  
furniture

Ventilated  
facades

Technical  
information

# TH2.0 OUTDOOR SOLUTIONS

**Special pieces**  
Pezzi speciali. Pièces spéciales. Formteile.

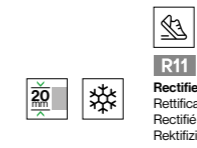

**Porcelain stoneware coloured in body**  
Gres porcellanato colorato in massa  
Grès cérame coloré dans la masse  
Eingefärbtes Feinsteinzeug

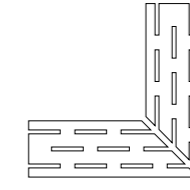
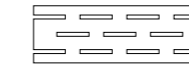
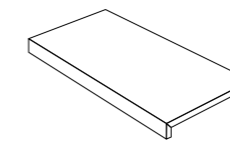
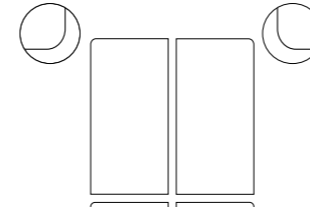
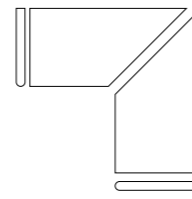
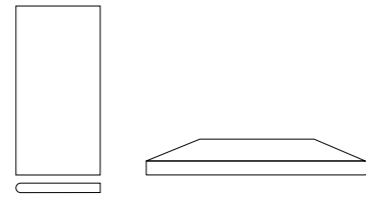

		<b>A</b> LINEAR ROUND ROUND LINEARE					<b>B</b> LH/RH ROUND ANGLE ROUND ANGOLARE DX/SX					<b>C</b> LH/RH BULL NOSE EDGE ANGLE ANGOLARE BORDO TORO DX/SX					<b>D</b> "L" PROFILE COSTA RETTA ELEMENTO A "L" COSTA RETTA				<b>E</b> GRILLE GRIGLIA			<b>F</b> LH/RH GRILLE ANGLE GRIGLIA ANGOLO DX/SX			
		30x60 12"x24" ±20 mm	30x120 12"x48" ±20 mm	40x80 16"x32" ±20 mm	60x90 24"x36" ±20 mm	60x120 24"x48" ±20 mm	30x60 12"x24" ±20 mm	30x120 12"x48" ±20 mm	40x80 16"x32" ±20 mm	60x90 24"x36" ±20 mm	60x120 24"x48" ±20 mm	30x60 12"x24" ±20 mm	30x120 12"x48" ±20 mm	40x80 16"x32" ±20 mm	60x90 24"x36" ±20 mm	60x120 24"x48" ±20 mm	30x60x5 12"x24"x2" ±20 mm	30x90x5 12"x36"x2" ±20 mm	40x80x5 16"x32"x2" ±20 mm	30x120x5 12"x48"x2" ±20 mm	20x60 8"x24" ±20 mm	20x80 8"x32" ±20 mm	20x90 8"x36" ±20 mm	20x60 8"x24" ±20 mm	20x80 8"x32" ±20 mm	20x90 8"x36" ±20 mm	
		Rectified Rettificato					Rectified Rettificato					Rectified Rettificato					Rectified Rettificato				Rectified Rettificato			Rectified Rettificato			
		Price code / pc. Codice prezzo / pz.					Price code / pc. Codice prezzo / pz.					Price code / pc. Codice prezzo / pz.					Price code / pc. Codice prezzo / pz.				Price code / pc. Codice prezzo / pz.			Price code / pc. Codice prezzo / pz.			
STONE LOOK	<b>Agathòs</b>	152	171			177	157	179			179	172	183			183	165			183	162				166		
	<b>Basaltina</b>	152	171		167	177	157	179		173	179	172	183		179	183	165	178		183	162			176	166		180
	<b>Ceppo di Grè</b>	152	171	166		177	157	179	172		179	172	183	178		183	165		176	183	162	174			166	179	
	<b>Genesis</b>	152	171			177	157	179			179	172	183			183	165			183	162					166	
	<b>Heritage</b>	152	171			177	157	179			179	172	183			183	165			183	162					166	
	<b>Hollstone</b>	152	171	166		177	157	179	172		179	172	183	178		183	165		176	183	162	174			166	179	
	<b>Loop</b>	152	171			177	157	179			179	172	183			183	165			183	162					166	
	<b>Medley</b>	152		166			157		172			172		178			165		176			162	174			166	179
	<b>Nereidi</b>	152	171			177	157	179			179	172	183			183	165			183	162					166	
	<b>Pennslate</b>	152	171		167	177	157	179		173	179	172	183		179	183	165	178		183	162			176	166		180
	<b>Pietra di Vals</b>	152	171	166	167	177	157	179	172	173	179	172	183	178	179	183	165	178	176	183	162	174	176	166	179	180	
	<b>Rushmore</b>	152	171		167	177	157	179		173	179	172	183		179	183	165	178		183	162			176	166		180
	<b>Spark</b>	152	171			177	157	179			179	172	183			183	165			183	162					166	
	<b>Sunstone</b>	152	171		167	177	157	179		173	179	172	183		179	183	165	178		183	162			176	166		180
	<b>Urano</b>	152	171	166	167	177	157	179	172	173	179	172	183	178	179	183	165	178	176	183	162	174	176	166	179	180	
<b>Wonder</b>	152	171		167	177	157	179		173	179	172	183		179	183	165	178		183	162			176	166		180	



# Maximum laying versatility

Massima versatilità di posa  
Polyvalence maximale d'installation  
Vielfaltigkeit der Verlegung

## A LAYING ON GRASS

POSA SU ERBA  
POSE SUR HERBE  
VERLEGUNG AUF GRAS

**A rapid, advantageous system. Just one tip: the underlying surface should be covered with stabilised material and an appropriate distance should be left between the tiles to facilitate rainwater drainage.**

Un sistema rapido e vantaggioso. Solo un accorgimento: si consiglia di coprire la superficie d'appoggio con stabilizzato e lasciare una distanza opportuna tra le mattonelle per rendere più agevole il deflusso dell'acqua piovana.

Un système rapide et avantageux. Un conseil seulement: il est recommandé de couvrir la surface d'appui avec un matériau stabilisé et de laisser une distance opportune entre les carreaux pour rendre plus simple l'écoulement de l'eau de pluie.

Ein schnelles, vorteilhaftes System. Wir empfehlen nur eine Vorkehrung: Bedecken Sie die Auflagefläche mit Schutt und lassen Sie ausreichend Abstand zwischen den Fliesen, um das Abfließen des Regenwassers zu erleichtern.

## C LAYING ON SAND

POSA SU SABBIA  
POSE SUR SABLE  
VERLEGUNG AUF SAND

**Eco-friendly, economical and fast, ideal for a floor you can walk on immediately, and which is easy to remove if required.**

Eco-friendly, economica e veloce consente di ottenere un pavimento immediatamente calpestabile sulla sabbia, nonché di procedere alla sua rimozione in caso di necessità.

Éco-friendly, économique et rapide, elle permet d'obtenir un sol immédiatement carrossable sur le sable, ainsi que de procéder à son retrait en cas de nécessité.

Ökologisch, preisgünstig und schnell: Man kann damit einen sofort betretbaren Fußboden auf Sand verlegen und ihn bei Bedarf einfach entfernen.

## E POSA SOPRAELEVATA

RAISED INSTALLATION  
POSE SURÉLEVÉE  
VERLEGUNG ALS DOPPELBODEN

## B LAYING ON GRAVEL

POSA SU GHIAIA  
POSE SUR GRAVIERS  
VERLEGUNG AUF KIES

**A quick laying system that makes it possible to handle TH2 independently, without the expense of specialised installers, as well as being eco-compatible, because it does not require screed, mortars or adhesives.**

Sistema di posa veloce, permette di gestire il TH2 in autonomia, senza l'impiego di oneroso personale specializzato, ed ecocompatibile, poiché non necessita di massetto malte e collanti.

Système de pose rapide qui permet de gérer le TH2 en toute autonomie, sans l'utilisation d'un personnel spécialisé onéreux et de manière éco-compatible, car ni mortier, ni adhésif, ni colle ne sont nécessaires.

Schnelles Verlegesystem, mit dem man TH2 selbstständig ohne Einsatz von kostenaufwendigem Fachpersonal verlegen kann. Außerdem ist es umweltverträglich, da man weder Estrich noch Mörtel und Kleber benötigt.

## D LAYING ON SCREED

POSA SU MASSETTO  
POSE SUR MORTIER  
VERLEGUNG AUF ESTRICH

**Even the most traditional laying system can be used, by spreading glue on screed. This technique guarantees maximum stress resistance, so as to render surfaces perfectly suitable for vehicular traffic.**

Non è escluso nemmeno il più classico dei metodi di posa, quello con l'utilizzo della colla su massetto, tecnica che garantisce la massima resistenza alle sollecitazioni, in modo da rendere le superfici perfettamente carrabili.

Même la plus classique des méthodes de pose n'est pas exclue, celle de l'utilisation de la colle sur mortier, une technique qui garantit la résistance maximale aux sollicitations de manière à rendre les surfaces parfaitement carrossables.

Auch die klassische Verlegungsmethode unter Verwendung von Kleber auf dem Estrich ist nicht ausgenommen. Es handelt sich dabei um eine Technik, die die größtmögliche Beständigkeit gegenüber den Belastungen gewährleistet, damit die Oberfläche perfekt befahrbar ist.

## F SPECIAL PIECES p. 464

PEZZI SPECIALI  
LES PIÈCES SPÉCIALES  
FORMSTÜCKE

General index

Product indexes

The Company

Collections

TH2.0  
Outdoor Solutions

Marble Look  
Concrete Look  
Stone Look  
Metal Look  
Wood Look  
Special pieces

Bathroom furniture

Ventilated facades

Technical information

# Raised installation: supports

Posa sopraelevata: supporti. Pose surélevée: supports. Erhöhte installation: support.

For raised installation, it is necessary to use polypropylene bearing supports, either fixed, adjustable or self-levelling, which can be placed at a variety of heights. The gap between the floor and the underlying surface allows for the passage of electric and plumbing systems.

Per la posa sopraelevata ci si serve di supporti portanti in polipropilene, siano essi fissi, regolabili o autolivellanti, collocabili a diverse altezze. L'intercapedine presente tra la pavimentazione e il piano d'appoggio permette il passaggio di impianti elettrici e idrici.

Pour la pose surélevée sont nécessaires des supports portants en polypropylène, que ceux-ci soient fixes, réglables ou auto-nivelants, et positionnables à différentes hauteurs. L'espace présent entre le sol et le plan d'appui permet le passage d'installations électriques et hydriques.

Für die Verlegung als Doppelboden verwendet man eine Tragstruktur aus Polypropylen-Stützen, die fest, verstellbar oder selbstnivellierend sind und in verschiedenen Höhen errichtet werden können. Der Zwischenraum zwischen dem Fußboden und der Auflagefläche ermöglicht die Durchführung der Strom- und Wasserleitungen.

## WATER RUNOFF ON RAISED FLOORS:

Thanks to the properties of porcelain stoneware, Energieker TH2.0 products have practically no water absorption, making them resistant to frost.

Please note that this characteristic can lead to water stagnation mainly located on the edges of the slabs, not attributable to the quality of the tiles, but to the physical phenomenon of surface tension together with low water absorption.

For correct water flow, installation with a minimum slope of 2% is recommended.

## DEFLUSSO DELLE ACQUE SU POSE SOPRAELEVATE:

Grazie alle proprietà del gres porcellanato, i prodotti Energieker TH2.0, hanno un assorbimento d'acqua praticamente nullo, rendendoli ingelivi. Si ricorda che tale caratteristica può comportare ristagni d'acqua localizzati principalmente sui bordi delle lastre, non imputabili alla qualità delle piastrelle, ma al fenomeno fisico della tensione superficiale unitamente al basso assorbimento dell'acqua. Per un corretto deflusso dell'acqua si consiglia la posa con una pendenza minima di 2%.

## ÉCOULEMENT DES EAUX SUR POSES SURÉLEVÉES:

Grâce aux propriétés du grès cérame, les produits Energieker TH2.0 n'ont pratiquement aucune absorption d'eau, ce qui les rend résistants au gel. Veuillez noter que cette caractéristique peut entraîner une stagnation d'eau principalement localisée sur les bords des dalles, non pas attribuable à la qualité des carreaux, mais au phénomène physique de tension de surface associé à une faible absorption d'eau.

Pour un bon écoulement de l'eau, il est recommandé une installation avec une pente minimale de 2%.

## WASSERABFLUSS BEI VERLEGUNG ALS HOHLRAUMBÖDEN:

Dank der technischen Eigenschaften von Feinsteinzeug haben Energieker TH2.0-Produkte praktisch keine Wasseraufnahme und gelten daher als absolut frostsicher. Bitte beachten Sie, dass aufgrund dieser Eigenschaft keine Flüssigkeit von den Platten aufgenommen werden kann und sich diese an den Plattenkanten sammeln können.

Dies beeinträchtigt keinesfalls die Qualität der Fliesen, sondern ist auf Oberflächenspannungen von Flüssigkeiten zurückzuführen.

Für einen erleichterten Wasserabfluss wird deshalb eine Verlegung mit einem Mindestgefälle von 2% empfohlen.

## ADVANTAGES

### VANTAGGI

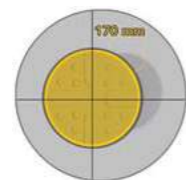

**High stability thanks to the wide head of the support.**

Elevata stabilità grazie alla testa larga del supporto.

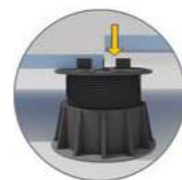

**Quick and easy installation.**

Installazione rapida e semplice.



**Respect for the waterproof membrane.**

Rispetto della membrana impermeabile.



**Allows the creation of a gap between the slabs and the wall to facilitate water drainage and stabilizes the terrace in case of heavy rain, snow, etc.**

Consente di creare un'intercapedine tra le lastre e il muro, per favorire lo scarico delle acque e stabilizza la terrazza in caso di forti piogge, neve, ecc.

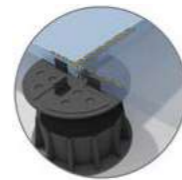

**Presence of open joints that prevent the risk of cracking compared to grouted joints. Simplified water drainage.**

Presenza di giunti aperti che evitano il rischio di fessurazione rispetto ai giunti stuccati. Evacuazione dell'acqua semplificata.

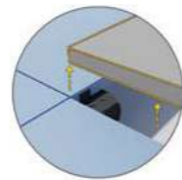

**Easy access to the waterproof membrane or the underlying structure.**

Accesso facile alla membrana impermeabile o alla struttura sottostante.



**Covering and protection of systems. Easy access for potential maintenance.**

Copertura e protezione degli impianti. Facile accesso per eventuali manutenzioni.



**Easy management of the slope up to 5%.**

Facile gestione della pendenza fino al 5%.



## Recommended support placement

Posizionamento consigliato dei supporti. Placement des supports recommandé. Empfohlene platzierung der stützen.

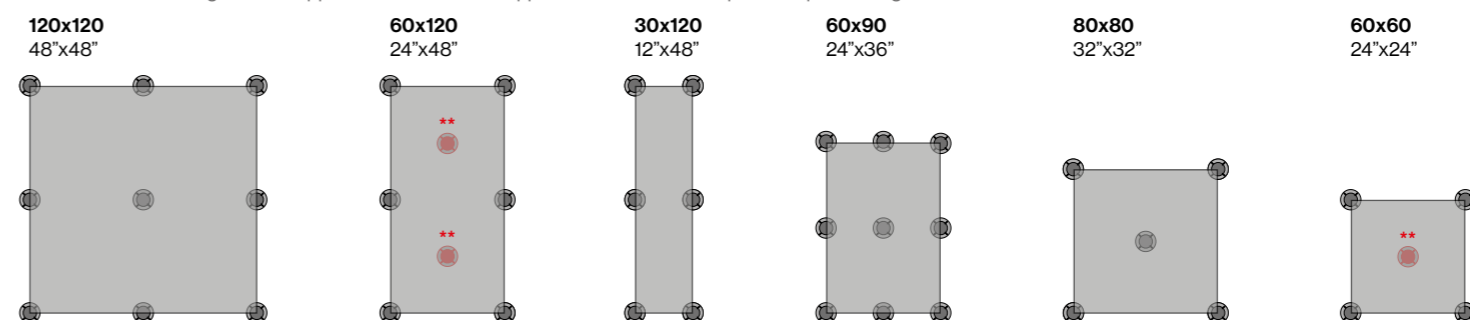

**\*\* For the installation of 10 cm or higher flooring, it is recommended to use an additional supporting tool at the centre of the slab.**

Per la posa di pavimentazioni con altezze superiori ai 10 cm si raccomanda l'utilizzo di un supporto supplementare al centro della lastra. Lors de la pose de carrelage de sol d'une hauteur supérieure à 10 cm, il est recommandé d'utiliser un support supplémentaire au centre de la dalle. Für die Verlegung von Böden mit einer Höhe von mehr als 10 cm wird empfohlen, eine zusätzliche Stütze in der Plattenmitte zu verwenden.

## Example of perimetral installation

Esempio di posa perimetrale. Exemple de pose périmétrique. Verlege beispiel mit einfassung.

**60x60**  
24"x24"

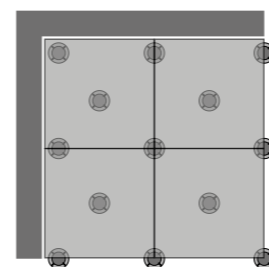

**60x120**  
24"x48"

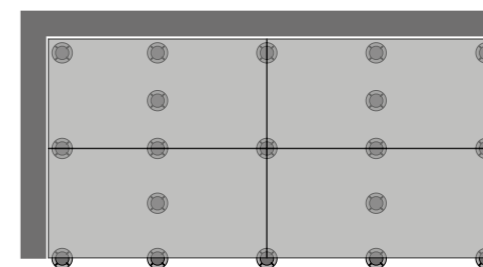

It is highly recommended to follow the above-mentioned suggestions, while complying to all relevant legislation in the country where goods are installed. Failure to respect these norms may cause severe safety issues.

Si raccomanda di seguire i suggerimenti sopra riportati unitamente al rispetto delle normative locali del paese in cui viene effettuata l'installazione. Il mancato rispetto di queste raccomandazioni potrebbe causare gravi problemi di sicurezza.

Il est recommandé de suivre les suggestions ci-dessus et de se conformer aux réglementations locales du pays d'installation. Le non-respect de ces recommandations peut entraîner de graves problèmes de sécurité.

Wir empfehlen, die o.g. Vorschläge in Einhaltung der örtlichen Vorschriften des jeweiligen Landes, in dem die Installation durchgeführt wird, zu befolgen. Die Nichtbeachtung dieser Empfehlungen kann zu ernsthaften Sicherheitsproblemen führen.

# Aluminium joists and reinforcement tools

Magatelli in alluminio e supporti. Lattes et supports en aluminium. Aluminiumprofile und support.



The system with aluminum profiles simplifies the installation of 20 mm ceramic slabs of any size. They guarantee superior resistance to applied loads and only require a distance of maximum 60 cm between each support.

Il sistema con i profili in alluminio semplifica la posa delle lastre in ceramica da 20 mm di qualunque dimensione. Garantiscono una resistenza superiore ai carichi applicati e necessitano soltanto di una distanza di 60 cm (max) tra ogni supporto.

Le système de profilés en aluminium simplifie l'installation de dalles céramiques de 20 mm, quelle que soit leur taille. Ils offrent une résistance supérieure aux charges appliquées et ne nécessitent qu'une distance de 60 cm (max.) entre chaque support.

Das System mit Aluminiumprofilen vereinfacht die Verlegung von 20 mm Keramikplatten beliebiger Größe. Sie garantieren eine hervorragende Widerstandsfähigkeit gegenüber den aufgetragenen Lasten und erfordern einen Abstand von (max.) 60 cm zwischen den einzelnen Stützen.

## POSITIONING OF THE CHOCKS POSIZIONAMENTO DEI MAGATELLI

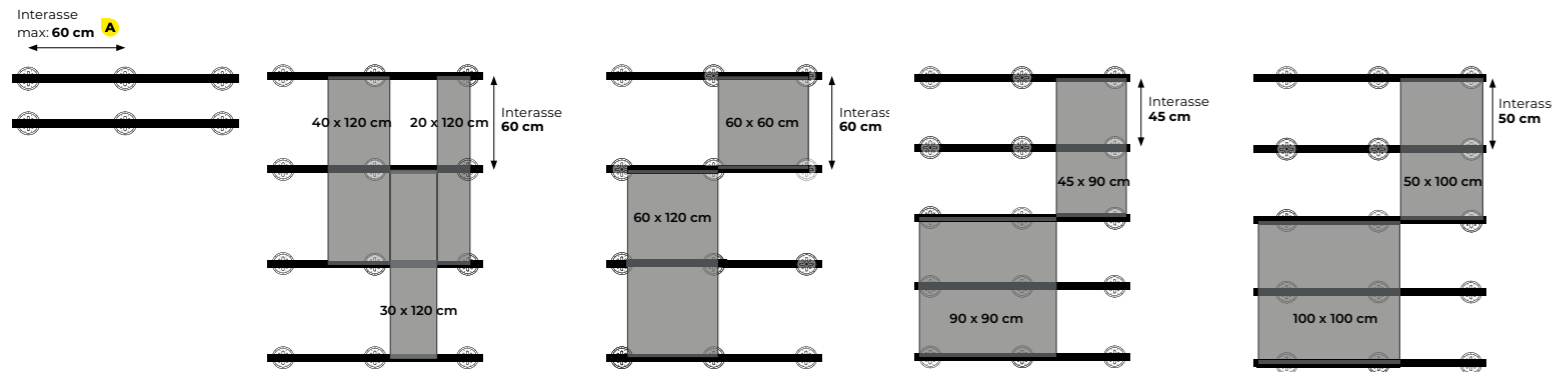

## ADVANTAGES VANTAGGI

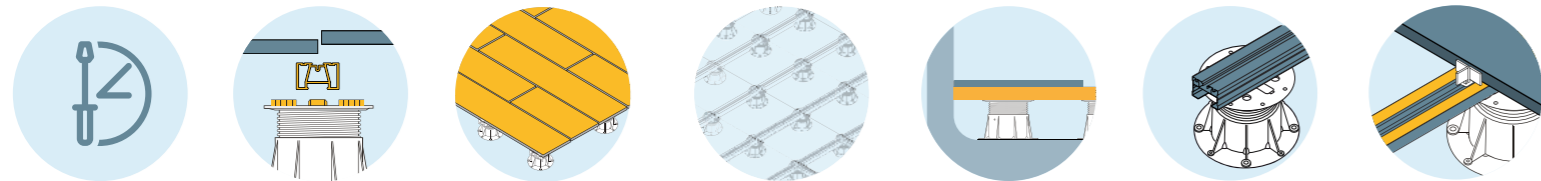

**Time-saving advantage.**  
Vantaggio di tempo.

**Simplified installation of supports.**  
Posa semplificata dei supporti

**Possibility of laying oversized slabs/boards.**  
(e.g. large format 120x120 cm or reduced width 20x120, 30x120 cm).

Possibilità di posa di lastre/tavolati fuori formato.  
(es. formato grande 120x120 cm o ridotta larghezza 20x120, 30x120 cm).

**Great stability of passage surfaces.**  
Grande stabilità delle superfici di passaggio.

**Stability of slabs at the wall edge.**  
Stabilità lastre a bordo muro.

**Quick attachment of the support to the chock.**  
Aggancio rapido del supporto al magatello.

**EPDM seal.**  
Guarnizione in EPDM.

# Raised installation: Standard EN 12825

Posa sopraelevata: Standard EN 12825. Pose surélevée: Standard EN 12825. Verlegung als Doppelboden: Standard EN 12825.

TEST TIPO DI TEST TYPE D'ESSAI PRÜFUNGSART	RESULT ESITO DELLA PROVA RESULTAT DE L'ESSAI PRÜFUNGSERGEBNIS
<b>Static load capacity / load bearing test</b> Carico statico / prova di carico sull' elemento Charge statique / essai de charge sur l'élément Statische belastung / belastungsprüfung auf dem element	<b>Test passed</b> Test superato Essai positif Prüfung bestanden
<b>Vertical load tested on columns/beams</b> Prova di carico verticale sulla colonna Essai de charge verticale sur la colonne porteuse Belastungsprüfung auf der stütze	<b>Test passed as stated by the supplier of support</b> Superamento test dichiarato dal fornitore del supporto Essai déclaré positif par le fournisseur du support Bestehen der prüfung durch den lieferanten der trägerstruktur bescheinigt.
<b>Test of permanent deformation</b> Prova di deformazione permanente sull' elemento Essai de déformation permanente sur l'élément Prüfung der bleibenden verformung auf dem element	<b>Test passed</b> Test superato Essai positif Prüfung bestanden
<b>Dynamic load capacity / hard object impact test</b> Carico dinamico / prova di urto di corpi duri Charge dynamique / essai d'impact de corps durs Dynamische belastung / stoßprüfung mit harten körpern	<b>Test passed</b> Test superato Essai positif Prüfung bestanden
<b>Dynamic load capacity / soft object impact test</b> Carico dinamico / prova di urto di corpi morbidi Charge dynamique / essai d'impact de corps mous Dynamische belastung / stoßprüfung mit weichen körper	<b>Test passed</b> Test superato Essai positif Prüfung bestanden
<b>Length of panel sides</b> Lunghezza dei lati del pannello Longueur des côtés de la dalle Kantenlängen der platte	<b>Test passed</b> Test superato Essai positif Prüfung bestanden
<b>Orthogonality of panel</b> Ortogonalità del pannello Equerrage de la dalle Rechtwinkligkeit der platte	<b>Test passed</b> Test superato Essai positif Prüfung bestanden
<b>Straightness of edges</b> Rettilineità dei lati Rectitude des côtés Geradheit der kanten	<b>Test passed</b> Test superato Essai positif Prüfung bestanden
<b>Thickness of panel</b> Spessore del pannello Epaisseur de la dalle Plattendicke	<b>Test passed</b> Test superato Essai positif Prüfung bestanden
<b>Warping of panel</b> Svergolamento del pannello Gauchissement du panneau Verwindung der platte	<b>Test passed</b> Test superato Essai positif Prüfung bestanden
<b>Vertical bend of panels</b> Incurvatura verticale dei pannelli Voilement vertical des dalles Verwindung der platten	<b>Test passed</b> Test superato Essai positif Prüfung bestanden
<b>Difference between outer edge and surface of panel</b> Differenza tra i bordi perimetrali e la superficie del pannello Différences de hauteurs entre la surface de la dalle et les finitions périphériques Höhenunterschied zwischen den kanten und der plattenoberseite	<b>Test passed</b> Test superato Essai positif Prüfung bestanden
<b>Protection against corrosion</b> Protezione contro la corrosione Protection contre la corrosion Schutz vor korrosion	<b>Not applicable / plastic support</b> Non applicabile / supporto in materiale plastico Non applicable / support en matériau plastique Nicht anwendbar / tragstruktur aus kunststoff
<b>Reaction to fire</b> Reazione al fuoco Réaction au feu Brandverhalten	<b>Not applicable to products for outdoor use</b> Non applicabile a prodotti per esterni Non applicable aux produits pour extérieurs Nicht anwendbar für produkte, die für außenbereiche bestimmt sind
<b>Electrostatic conductivity</b> Conduttività elettrostatica Conductivité électrostatique Elektrostatische leitfähigkeit	<b>Not applicable to products for outdoor use</b> Non applicabile a prodotti per esterni Non applicable aux produits pour extérieurs Nicht anwendbar für produkte, die für außenbereiche bestimmt sind

REGULATIONS AND RECOMMENDATIONS FOR RAISED FLOORS - There are currently no regulations governing raised floors for outdoor use only. The only pertinent regulation is UNI EN 12825 "raised flooring" of August 2001, the exclusive field of application of which is "raised floors for which the main use contemplated is internal finishings of buildings". With reference to this regulation, the TH2 system is able to comply with the performance requisites set out in the table. Although the "Dynamic load - hard object impact" test reproduces unlikely situations, such as the fall of a 4,5 kg weight from a height of 60 cm, EnergieKer recommends carefully evaluating the type and height of the structure, based on the intended use, and that the raised floor should have a maximum height of 10 cm.

NORME VIGENTI E RACCOMANDAZIONI PER LA SOLA POSA SOPRAELEVATA - Ad oggi, non esiste alcuna norma relativa ai pavimenti sopraelevati ad uso esclusivo per esterni. L'unica normativa di riferimento è la UNI EN 12825 "pavimenti sopraelevati" dell'agosto 2001 che, nel proprio ed esclusivo campo di applicazione, è destinata a "pavimenti sopraelevati per i quali l'utilizzo principale previsto è la finitura interna di edifici". Con riferimento a tale norma, il TH2 è in grado di soddisfare i requisiti prestazionali riportati nella tabella. Nonostante il test "Carico dinamico - prova di urto di corpi duri" riproduca situazioni inconsuete, come la caduta di un peso di 4,5 kg da 60 cm di altezza, EnergieKer raccomanda di valutare attentamente la tipologia e l'altezza della struttura in base alla destinazione d'uso e di realizzare una posa sopraelevata di altezza massima di 10 cm.

NORMES EN VIGUEUR ET RECOMMANDATIONS POUR LA POSE SURÉLEVÉE UNIQUEMENT - Il n'existe actuellement aucune norme relative aux sols surélevés pour l'utilisation exclusive en extérieur. L'unique norme de référence est l'UNI EN 12825 "sols surélevés" du mois d'août 2001 qui, dans son domaine unique et exclusif d'application, est destinée aux "sols surélevés pour lesquels l'utilisation principale prévue est la finition interne de bâtiments". En référence à cette norme, le TH2 est en mesure de satisfaire les conditions performances indiquées dans le tableau. Bien que le test "Charge dynamique - essai de choc de corps durs" reproduise des situations inhabituelles, comme la chute d'un poids de 4,5 kg de 60 cm de hauteur, EnergieKer conseille d'évaluer attentivement la typologie et la hauteur de la structure en fonction de sa destination d'utilisation et de réaliser une pose surélevée d'une hauteur maximum de 10 cm.

GÜLTIGE NORMEN UND EMPFEHLUNGEN SPEZIELL FÜR DIE VERLEGUNG ALS DOPPELBODEN - Bis jetzt gibt es keine Norm für ausschließlich für den Außenbereich vorgesehene Doppelböden. Die einzige Bezugsnorm ist die UNI EN 12825 „Doppelböden“ vom August 2001, die als ausschließlichem Anwendungsbereich für „Doppelböden, deren vorgesehene Hauptbestimmung in der Innenausstattung von Gebäuden besteht“ bestimmt sind. Unter Bezugnahme auf diese Norm ist TH2 fähig, die in der Tabelle angeführten Leistungsanforderungen zu erfüllen. Auch, wenn der Test „Dynamische Belastung - Aufprallprüfung mit harten Schlagkörpern“ ungewöhnliche Situationen wie den Aufprall eines 4,5 kg-Gewichts aus 60 cm Höhe simuliert, empfiehlt EnergieKer, die Typologie und Höhe der Struktur sorgfältig je nach der Gebrauchsbestimmung zu wählen und den Boden in höchstens 10 cm Höhe zu verlegen.

# Bathroom furniture

Arredi per il bagno  
Mobilier pour la salle de bain  
Badezimmermöbel



**Energieker brings ceramic excellence to bathroom furnishing with washbasins, shower trays, shelves and other solutions that combine design and functionality. Every detail is designed to guarantee resistance, stylistic continuity and exceptional durability over time.**

Energieker porta l'eccellenza ceramica nell'arredo bagno con lavabi, piatti doccia, mensole e altre soluzioni che coniugano design e funzionalità. Ogni dettaglio è pensato per garantire resistenza, continuità stilistica e un'eccezionale durata nel tempo.

Energieker apporte l'excellence céramique dans l'ameublement de la salle de bain avec des lavabos, des receveurs de douche, des étagères et autres solutions alliant design et fonctionnalité. Chaque détail est conçu pour garantir résistance, continuité stylistique et une durabilité exceptionnelle dans le temps.

Energieker bringt keramische Exzellenz in die Badezimmereinrichtung mit Waschbecken, Duschwannen, Regalen und anderen Lösungen, die Design und Funktionalität vereinen. Jedes Detail ist darauf ausgelegt, Widerstandsfähigkeit, stilistische Kontinuität und eine außergewöhnliche Langlebigkeit zu gewährleisten.

# Bathroom furniture

Arredi per il bagno. Mobilier pour la salle de bain. Badezimmernöbel.

## Surface-mounted washbasin

With stainless steel click clack drain.

Vasca lavabo da appoggio

Con piletta click clack in acciaio inox.



Sizes (cm) Dimensioni (cm)	Price Prezzo
60L x 40P x 15H	2.934,50 €/pc

Angled internal washbasin cover (included).

Copertura interna inclinata per vasca lavabo da appoggio (inclusa).

## Integrated top with 1 washbasin

With stainless steel click clack drain.

Top lavabo integrato 1 vasca

Con piletta click clack in acciaio inox.

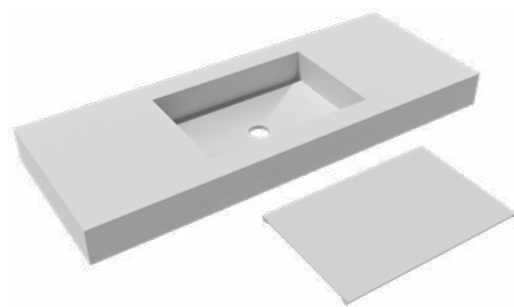

Sizes (cm) Dimensioni (cm)	Price Prezzo
90L x 55P x 15H *   **	3.257,60 €/pc
120L x 55P x 15H *   **	3.348,83 €/pc
121<-L- x 240 x 55P x 15H *   **	+13,58 €/cm L

Angled internal washbasin cover (included).

Copertura interna inclinata per vasca lavabo da appoggio (inclusa).

## Integrated top with large washbasin

With stainless steel click clack drain.

Top lavabo integrato vasca grande

Con piletta click clack in acciaio inox.

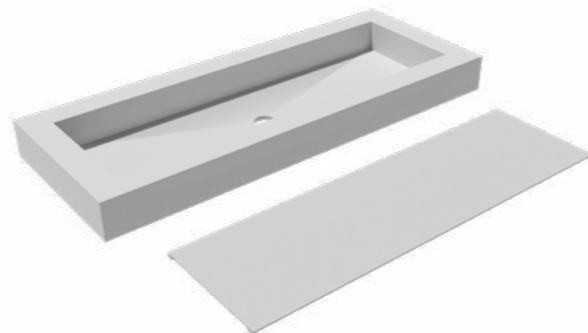

Sizes (cm) Dimensioni (cm)	Price Prezzo
90L x 55P x 15H *	3.326,02 €/pc
120L x 55P x 15H *	3.417,25 €/pc

Angled internal washbasin cover (included).

Copertura interna inclinata per vasca lavabo da appoggio (inclusa).

## Integrated top with large washbasin

With stainless steel click clack drain.

Top lavabo integrato 2 vasche

Con piletta click clack in acciaio inox.

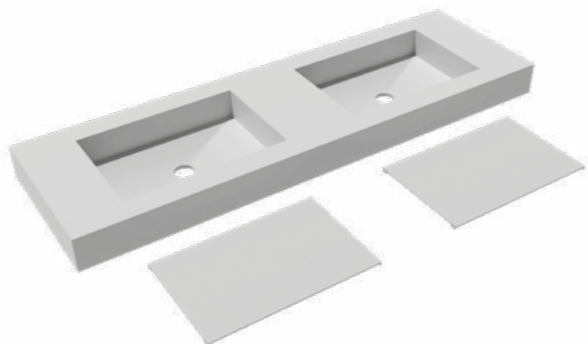

Sizes (cm) Dimensioni (cm)	Price Prezzo
160L x 55P x 15H *   ***	4.610,82 €/pc
200L x 55P x 15H *   ***	4.888,30 €/pc
240L x 55P x 15H *   ***	5.629,53 €/pc

Angled internal washbasin cover (included).

Copertura interna inclinata per vasca lavabo da appoggio (inclusa).

## Pedestal-mounted washbasin

Always-open drain.

Lavabo a semicolonna

Scarico sempre aperto.

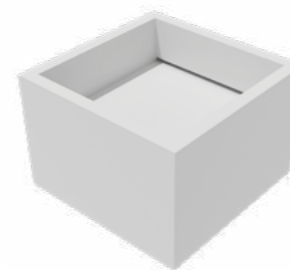

Sizes (cm) Dimensioni (cm)	Price Prezzo
50L x 50P x 40H	3.424,85 €/pc

## Pedestal-mounted washbasin

Always-open drain.

Waste hole can be placed on the ground or on the floor.

Lavabo a colonna

Scarico sempre aperto.

Foro per lo scarico posizionabile a terra o a parete.

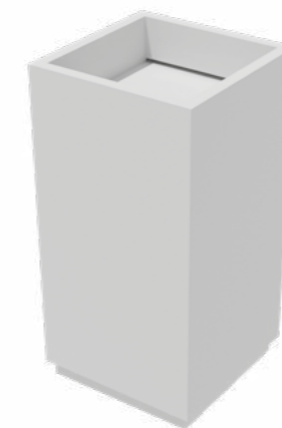

Sizes (cm) Dimensioni (cm)	Price Prezzo
50L x 50P x 85H	4.321,93 €/pc

\* Specify position of top holes only when necessary

Specificare posizionamento fori per rubinetteria se necessario

\*\* Item can be ordered on demand in lengths from 120 cm to 240 cm

Art. ordinabile on demand con lunghezza superiore a 120 cm e fino a 240 cm

\*\*\* Item can be ordered on demand in lengths from 100 cm to 220 cm

Art. ordinabile on demand con lunghezza superiore a 100 cm e fino a 220 cm

## Washbasin top

Top porta lavabo

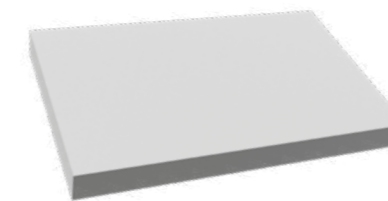

Sizes (cm) Dimensioni (cm)	Price Prezzo
90L x 55P x 8H *   **	2.546,78 €/pc
120L x 55P x 8H *   **	2.774,85 €/pc
121<-L- x 240 x 35P x 4H *   **	+13,58 €/cm L

## Vanity top

Top porta oggetti

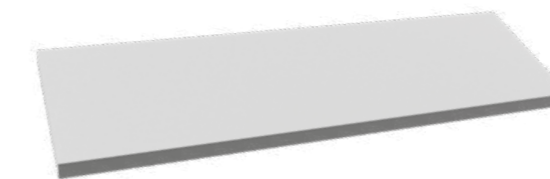

Sizes (cm) Dimensioni (cm)	Price Prezzo
90L x 35P x 4H **	2.371,93 €/pc
120L x 35P x 4H **	2.600,00 €/pc
121<-L- x 240 x 35P x 4H **	+13,58 €/cm L

## Shower tray

Piatto doccia



Sizes (cm) Dimensioni (cm)	Price Prezzo
120L x 80P x 4H	4.270,99 €/pc
120L x 90P x 4H	4.492,22 €/pc
140L x 90P x 4H	4.565,96 €/pc
140L x 90P x 4H	4.824,06 €/pc
160L x 90P x 4H	4.860,94 €/pc
160L x 90P x 4H	5.155,91 €/pc

Gross prices (€)

I prezzi indicati sono lordi (€)



# Ventilated facades

Facciate ventilate  
Façades ventilées  
Hinterlüftete Fassade

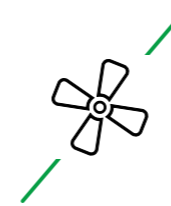
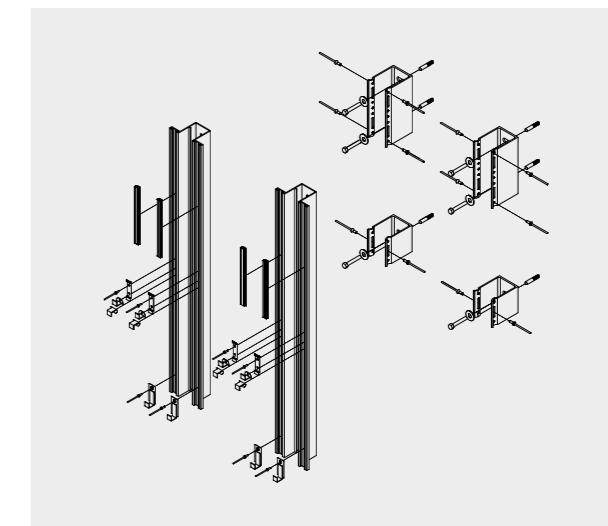
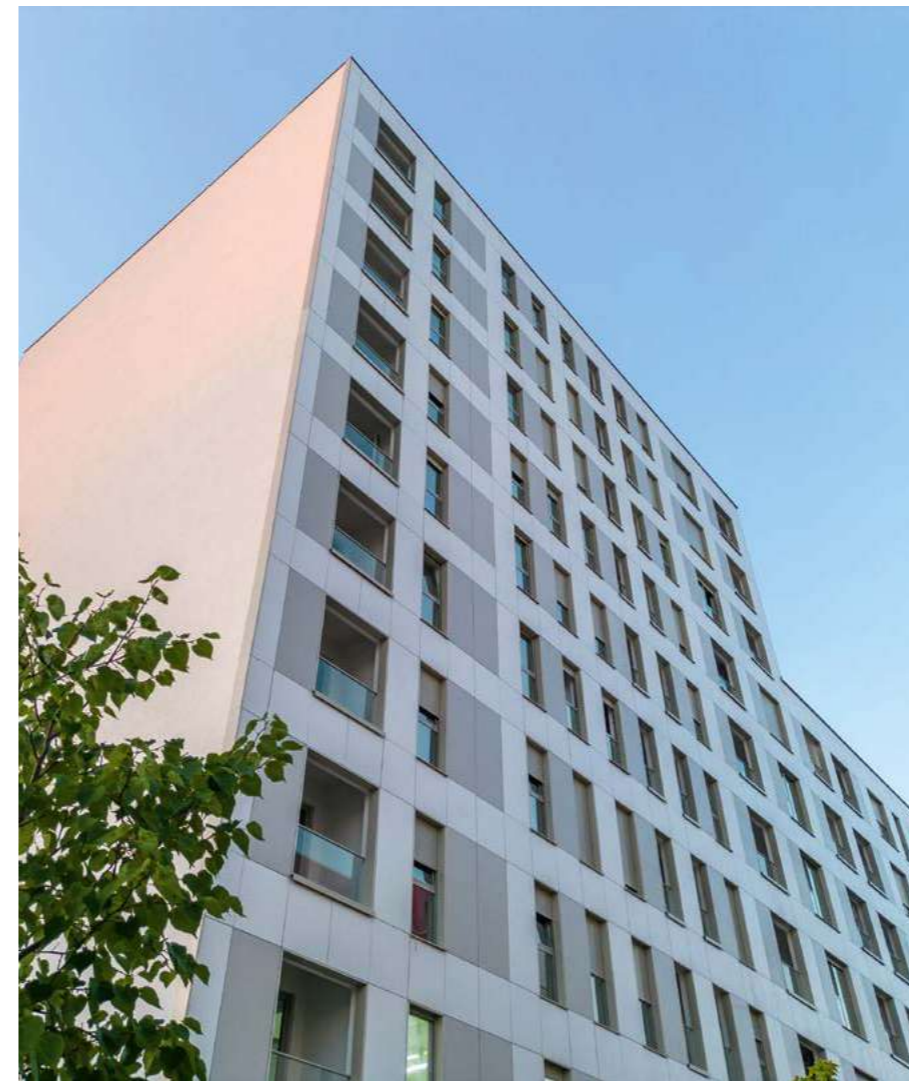

**Ventilation**  
Ventilazione  
Ventilation  
Belüftung



**Protection**  
Protezione  
Protection  
Schutz

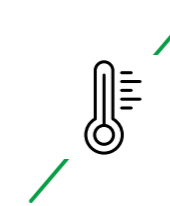

**Thermal stability**  
Stabilità termica  
Stabilité thermique  
Thermische Stabilität

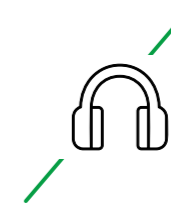

**Sound insulation**  
Isolamento acustico  
Isolation acoustique  
Schalldämmung

**Energieker surfaces can be used for the construction of ventilated walls because they are designed to optimize ventilation and thermal and acoustic insulation. Resistant to atmospheric agents, they guarantee high performance and safety, in full compliance with regulations.**

Le superfici Energieker possono essere utilizzate per la realizzazione di pareti ventilate perché progettate per ottimizzare ventilazione e isolamento termico e acustico. Resistenti agli agenti atmosferici, garantiscono prestazioni elevate e sicurezza, nel pieno rispetto delle normative.

Les surfaces Energieker peuvent être utilisées pour la réalisation de murs ventilés car elles sont conçues pour optimiser la ventilation et l'isolation thermique et acoustique. Résistantes aux agents atmosphériques, elles garantissent des performances élevées et la sécurité, dans le plein respect des réglementations.

Energieker-Oberflächen können für den Bau von hinterlüfteten Fassaden verwendet werden, da sie so konzipiert sind, dass sie die Belüftung sowie die Wärme- und Schalldämmung optimieren. Sie sind witterungsbeständig, garantieren hohe Leistung und Sicherheit unter voller Einhaltung der Vorschriften.

# Installation advice

Consigli di posa. Conseils de pose. Verlegehinweise.

Verlegen Sie die Fliesen wie folgt:

1. NO CLAIMS WILL BE ACCEPTED FOR LAID MATERIALS.

2. CHECK THE SHADE, WORKSIZE, SELECTION AND THE WARPAGE BEFORE LAYING THE MATERIAL.

3. ELECTRONIC MACHINES THAT SET THE WORKSIZE ARE CALIBRATED WITH A TOLERANCE OF 1.2 mm.

4. THE MATERIAL MUST BE LAID WITH A MINIMUM JOINT OF 3 mm. THE RECTIFIED MATERIAL MUST BE LAID WITH A MINIMUM JOINT OF 2 mm. The "Campigiane" series (thin paving bricks) must be laid with a joint of 5 mm.

#### RECOMMENDATIONS FOR INSTALLATION

When setting the tiles, pls chec tone, caliber and choice. Our material is deliberately produced and chosen with slight differences in shade which underline the colour effect it is absolutely necessary to use tiles from different boxes when installing. The use of material different from the order or defective means acceptance of the quality characteristics of the goods and excludes complaints. Complaints about material already installed will not be accepted.

#### INSTALLATION SUGGESTIONS FOR ALL RECTANGULAR FORMATS IN THE CATALOGUE

You will find a few suggestions for making the most of the product at the installation stage. A basic strategy to adopt when laying our product is to carefully alternate the different shades taking the tiles three or four at a time from at least five different boxes. Harmoniously distribute the various shades that are most striking and check the result from time to time, surveying the section of work done, from a suitable distance. The materials should be checked before installation and put aside if they are defective because no compliants will be accepted that have already been installed.

#### INSTALLATION OF RECTIFIED MATERIALS

For the installation of rectified materials it is anyway essential to keep a gap between the tiles of at least 2/3 mm. Using grouts and sealers that are colour co-ordinated with the material. When laying rectangular rectified material, it is important to avoid placing the edges of each tile next to the halves of others in order to compensate for any imperfections in flatness that are, however, always present in large sizes. As this is cut and rectified material to avoid the problem it is recommended to lay the material in a straightforward design with an interval from 0 to 15 cm. Between each tile as per the pattern shown below. It is highly suggested to have the installation done by qualified experts who, after checking the proper flatness of the concrete slab and the quality of the material, will contribute to carrying out of the job flawlessly.

#### WASHING AFTER INSTALLATION

Washing after installation is a very important, fundamental phase for all later interventions and for the maintenance. The following is achieved by washing after the installation:

- Remove installation residue (mortar, adhesive, paint and various types of dirt in general).

- Remove any residue from the surface of the material.

It's an important fact to know that over 90% of claims in building sites are due to a bad washing procedure or even due to the lack of washing after installation.

#### WATER RUNOFF ON RAISED FLOORS:

We recommend you give the floor a slight slope (at least 1%).

We recommend you use metal clips to fasten each slab in order to break the surface tension of the water in the event of pooling, thereby aiding runoff.

We recommend that you always use a central support for every floor tile laid.

TH2.0:

Gres protector - Faber

Enhancer Plus - Faber

Stop Dirty - Fila

TH2.0:

Gres protector - Faber

Enhancer Plus - Faber

Stop Dirty - Fila

TH2.0:

Gres protector - Faber

Enhancer Plus - Faber

Stop Dirty - Fila

TH2.0:

Gres protector - Faber

Enhancer Plus - Faber

Stop Dirty - Fila

TH2.0:

Gres protector - Faber

Enhancer Plus - Faber

Stop Dirty - Fila

TH2.0:

Gres protector - Faber

Enhancer Plus - Faber

Stop Dirty - Fila

Gres protector - Faber

Enhancer Plus - Faber

Stop Dirty - Fila

TH2.0:

Gres protector - Faber

Enhancer Plus - Faber

Stop Dirty - Fila

TH2.0:

Gres protector - Faber

Enhancer Plus - Faber

Stop Dirty - Fila

Gres protector - Faber

Enhancer Plus - Faber

Stop Dirty - Fila

TH2.0:

Gres protector - Faber

Enhancer Plus - Faber

Stop Dirty - Fila

TH2.0:

Gres protector - Faber

Enhancer Plus - Faber

Stop Dirty - Fila

TH2.0:

Gres protector - Faber

Enhancer Plus - Faber

Stop Dirty - Fila

TH2.0:

Gres protector - Faber

Enhancer Plus - Faber

Stop Dirty - Fila

TH2.0:

Gres protector - Faber

Enhancer Plus - Faber

Stop Dirty - Fila

TH2.0:

Gres protector - Faber

Enhancer Plus - Faber

Stop Dirty - Fila

TH2.0:

Gres protector - Faber

Enhancer Plus - Faber

Stop Dirty - Fila

TH2.0:

Gres protector - Faber

Enhancer Plus - Faber

Stop Dirty - Fila

TH2.0:

Gres protector - Faber

Enhancer Plus - Faber

Stop Dirty - Fila

TH2.0:

Gres protector - Faber

Enhancer Plus - Faber

Stop Dirty - Fila

TH2.0:

Gres protector - Faber

Enhancer Plus - Faber

Stop Dirty - Fila

TH2.0:

Gres protector - Faber

Enhancer Plus - Faber

Stop Dirty - Fila

TH2.0:

Gres protector - Faber

Enhancer Plus - Faber

Stop Dirty - Fila

TH2.0:

Gres protector - Faber

Enhancer Plus - Faber

Stop Dirty - Fila

Gres protector - Faber

Enhancer Plus - Faber

Stop Dirty - Fila

TH2.0:

Gres protector - Faber

Enhancer Plus - Faber

Stop Dirty - Fila

TH2.0:

Gres protector - Faber

Enhancer Plus - Faber

Stop Dirty - Fila

TH2.0:

Gres protector - Faber

Enhancer Plus - Faber

Stop Dirty - Fila

TH2.0:

Gres protector - Faber

Enhancer Plus - Faber

Gres protector - Faber

Enhancer Plus - Faber

Stop Dirty - Fila

TH2.0:

Gres protector - Faber

Enhancer Plus - Faber

Stop Dirty - Fila

TH2.0:

Gres protector - Faber

Enhancer Plus - Faber

Stop Dirty - Fila

TH2.0:

Gres protector - Faber

Enhancer Plus - Faber

Stop Dirty - Fila

TH2.0:

Gres protector - Faber

Enhancer Plus - Faber

Stop Dirty - Fila

TH2.0:

Gres protector - Faber

Enhancer Plus - Faber

Stop Dirty - Fila

TH2.0:

Gres protector - Faber

Enhancer Plus - Faber

Stop Dirty - Fila

TH2.0:

Gres protector - Faber

Enhancer Plus - Faber

Stop Dirty - Fila

TH2.0:

Gres protector - Faber

Enhancer Plus - Faber

Stop Dirty - Fila

TH2.0:

Gres protector - Faber

Enhancer Plus - Faber

Stop Dirty - Fila

TH2.0:

Gres protector - Faber

Enhancer Plus - Faber

Stop Dirty - Fila

TH2.0:

Gres protector - Faber

Enhancer Plus - Faber

Stop Dirty - Fila

TH2.0:

Gres protector - Faber

Enhancer Plus - Faber

Stop Dirty - Fila

TH2.0:

Gres protector - Faber

Enhancer Plus - Faber

Stop Dirty - Fila

TH2.0:

Gres protector - Faber

Enhancer Plus - Faber

Stop Dirty - Fila

TH2.0:

Gres protector - Faber

Enhancer Plus - Faber

Stop Dirty - Fila

TH2.0:

Gres protector - Faber

Enhancer Plus - Faber

Stop Dirty - Fila

TH2.0:

Gres protector - Faber

Enhancer Plus - Faber

Stop Dirty - Fila

TH2.0:

Gres protector - Faber

Enhancer Plus - Faber

Stop Dirty - Fila

TH2.0:

Gres protector - Faber

Enhancer Plus - Faber

Stop Dirty - Fila

TH2.0:

Gres protector - Faber

Enhancer Plus - Faber

Stop Dirty - Fila

TH2.0:

Gres protector - Faber

Enhancer Plus - Faber

Stop Dirty - Fila

TH2.0:

Gres protector - Faber

Enhancer Plus - Faber

Gres protector - Faber

Enhancer Plus - Faber

Stop Dirty - Fila

TH2.0:

Gres protector - Faber

Enhancer Plus - Faber

Stop Dirty - Fila

TH2.0:

Gres protector - Faber

Enhancer Plus - Faber

Stop Dirty - Fila

TH2.0:

Gres protector - Faber

Enhancer Plus - Faber

Stop Dirty - Fila

TH2.0:

Gres protector - Faber

Enhancer Plus - Faber

Stop Dirty - Fila

TH2.0:

Gres protector - Faber

Enhancer Plus - Faber

Stop Dirty - Fila

TH2.0:

Gres protector - Faber

Enhancer Plus - Faber

Stop Dirty - Fila

TH2.0:

Gres protector - Faber

Enhancer Plus - Faber

Stop Dirty - Fila

TH2.0:

Gres protector - Faber

Enhancer Plus - Faber

Stop Dirty - Fila

TH2.0:

Gres protector - Faber

Enhancer Plus - Faber

Stop Dirty - Fila

TH2.0:

Gres protector - Faber

Enhancer Plus - Faber

Stop Dirty - Fila

TH2.0:

Gres protector - Faber

Enhancer Plus - Faber

Stop Dirty - Fila

TH2.0:

Gres protector - Faber

Enhancer Plus - Faber

Stop Dirty - Fila

TH2.0:

Gres protector - Faber



# Cleaning and care of Energieker products

Pulizia e manutenzione dei prodotti. Nettoyage et entretien des articles Energieker.  
Reinigung und pflege der produkte von Energieker.

Apart from their refined aesthetic presence, all surfaces by Energieker provide you with the highest technical standards. Easy to clean, spot-resistant and resistant to contact with acids. For any further question on how to obtain the best results in cleaning, to find out more about the chosen surface and its relative cleansers and cleaning procedures, please scan the QR code on the right.

Le superfici Energieker oltre ad una presenza estetica raffinata garantiscono standard tecnici di assoluto valore. Facili da pulire, resistono alle macchie e non si deteriorano al contatto con acidi. Per ottenere i migliori risultati nella pulizia e avere informazioni relative al tipo di finitura scelto, sulle corrette procedure e adottare il tipo di detergente adatto inquadra il QR Code a fianco.

Les surfaces Energieker garantissent une présence esthétique raffinée ainsi que des standards techniques d'une valeur absolue. Ils sont faciles à nettoyer, résistent aux taches et ne se détériorent pas au contact des acides. Pour obtenir les meilleurs résultats et des informations sur le type de finition choisi, les procédures correctes et le bon type de détergent, scannez le code QR ci-contre.

Die Energieker-Oberflächen garantieren neben einer edlen ästhetischen Präsenz technische Standards von absoluter Wertigkeit. Sie sind leicht zu reinigen, Fleckbeständig und Säurefest. Scannen Sie den QR-Code auf der Seite, um Tipps für beste Reinigungsergebnisse zu erhalten und Informationen zur Oberflächenbehandlung, sowie den richtigen Reinigungsmitteltyp zu erhalten.



# General terms of sale

Condizioni generali di vendita. Conditions générales de vente. Allgemeine verkaufsbedingungen.

## General information

**WARNING** - The colours and aesthetic features of the products in this catalog and in all merchandising tools are indicative and cannot be reproduced on printed paper with utmost fidelity.

**APPROVAL** - All orders that we receive are considered to be binding only after our written confirmation has been issued.

**DELIVERY** - The materials are intended as delivered upon loading at our warehouses. All transport risks, including missing pieces, breakage, deterioration and tampering are the sole responsibility of the Client, even if the price agreed upon is carriage free, FOB, or C&F. Agreements with forwarding agents are intended as concluded in the name of and on behalf of the Client, who hereby confirms and accepts their terms and conditions.

**TERMS OF DELIVERY** - The terms of delivery are indicative, eventual delays in the delivery, interruptions, or total or partial suspensions of the supply do not allow any right to compensation for damages.

**DISPUTES** - The guarantee of the goods is limited only and exclusively to first choice materials. The difference in shades of color cannot be declared as a material defect. Eventual complaints regarding the quality or the type of material must be submitted within 8 days from the date of delivery. The purchaser agrees to make available the disputed lots in order that the declared defects may be controlled. In any case, the installation exonerates the manufacturer from any liability. Eventual manufacturing defects or quality defects in the goods, when declared according to law and ascertained or recognized, give right only to the replacement of the defective materials, provided that the goods have been returned previously and the written authorization of the return operation has been issued, the resolution of the contract as well as any compensation for damages is peremptorily waived and excluded.

**DIMENSIONS AND TONALITY** - Our materials are classified as products fired at high temperatures and as such may present discrepancies between the dimensions declared and those actually delivered. The same applies for differences in colors within the same production lot. Therefore, the client may not present a dispute regarding abovementioned product characteristics.

**PACKAGING AND QUANTITY** - The good condition of the packaging and cartons as well as the quantity delivered are verified upon acceptance of the goods by the forwarding agent. The forwarding agent declares himself responsible for the condition and quantity of the goods upon signing the packing list. In case of missing pieces or breakage, the purchaser must ask for eventual damages or compensation from the forwarding agent.

**RETURNS** - For no reason will the purchaser be able to return the material without our express prior written authorization and provided that the material is in good condition. All the costs related to the authorized return will be assumed by the Client. In case of a return, authorized in writing only, of empty packaging for big size (crates and/or A-frames) in good conditions, a maximum of 80% of the initial value charged will be reimbursed due to depreciation.

**CANCELLATIONS** - Order cancellations will not be accepted if the material has already been produced or if the production has already begun, and more so if the materials have already been shipped. In any case, the Client is obliged to pay the entire sum of the supply if the order is cancelled. If the acceptance of the cancellation is feasible, the Client will be peremptorily obliged to reimburse all the expenses sustained by the producer up to that moment.

**PRICES** - The prices on our price list are not binding. We reserve the right to modify prices before accepting an order.

**PAYMENT** - Payments must be made only in our main office. Delays of more than 10 days for each payment due or insufficient funds during the same term of a check, whether endorsed or transferred, or issued by the customer, constitutes bad debt. In this case, we reserve the right to suspend supply and cancel all ongoing relations, immediately require total payment of all ongoing relations; require total payment of each credit and to make legal recourse, whether executive or precautionary, as well as request compensation for damages. Annual penalty interest will accumulate on the expired debt to be calculated according to the current legal interest rate, plus 5%.

**MINIMUM PACKAGING REQUIREMENTS** - Sales of less than one box will not be allowed.

**DELIVERY SERVICE TO OUR DEPOSIT IN MARANELLO** The service to our warehouse in Maranello will be charged as follows: - from 0 to 1000 Kg € 4.00 - from 1000 to 8000 Kg €0.90 per quintal.

**SELLER'S LIEN** - The material, even if shipped and regularly invoiced, remains our property until payment in full of the invoice itself, even in case of passage or sale to third parties.

**V.A.T.** - Must be paid in any case before and no later than 60 days from the issuing of the invoice.

**PLACE OF JURISDICTION** - For any eventual dispute, the only place of jurisdiction will be the Court of Modena.

### IT

**AVVERTENZA** - I colori e le caratteristiche estetiche dei prodotti nel presente catalogo e in tutti gli strumenti di merchandising sono indicativi in quanto non riproducibili su carta stampata con assoluta fedeltà.

**APPROVAZIONE** - Gli ordini pervenuti ci sono per noi impegnativi solo dopo la nostra conferma scritta.

**CONSEGNA** - La consegna del materiale s'intende avvenuta a carico

effettuato presso i nostri magazzini. “Tutti i rischi di trasporto, compresi ammanchi, rotture, deterioramenti e manomissioni sono a carico del Committente anche se il prezzo pattuito è franco di porto, FOB o C&F. Gli accordi con spedizionieri s'intendono sempre conclusi in nome e per conto del Committente che ne accetta l'operato.

**TERMINI DI CONSEGNA** - I termini di consegna hanno carattere indicativo, eventuali ritardi nelle consegne, interruzioni, sospensioni totali o parziali delle forniture non daranno diritto ad indennizzi o risarcimento danni.

**CONTESTAZIONI** - La garanzia della merce e limitata al solo, ed esclusivamente, materiale di prima scelta. Le differenze di tonalità non potranno essere denunciate come vizio del materiale. Eventuali reclami in merito alla qualità, tipo del materiale, dovranno pervenirci entro 8 giorni dalla data della consegna. Il compratore s'impegna a tenere a disposizione le partite contestate così da consentire il controllo dei difetti denunciati, in ogni caso la posa in opera ci esonerà da qualsiasi responsabilità. Eventuali vizi o difetti di qualità della merce, ove siano denunciati nei termini di legge ed accertati o riconosciuti, danno diritto solamente alla sostituzione dei materiali difettosi, a condizione della preventiva restituzione delle merci contestate, e, su autorizzazione scritta dell'operazione di resa, restando tassativamente ed esclusi la risoluzione del contratto qualsiasi risarcimento danno.

**DIMENSIONI E TONALITÀ** - I nostri materiali sono da classificarsi fra i prodotti cotti a alta temperatura e come tali possono presentare differenze fra le dimensioni dichiarate e quelle effettivamente consegnate. Così si dica per le differenze di tono all'interno della medesima partita. Quanto sopra perciò non potrà essere oggetto di reclamo da parte del committente.

**IMBALLO E QUANTITÀ** - Il buono stato degli imballi e della loro confezione nonché della quantità consegnata resta accertato con l'accettazione della merce da parte del vettore. Quest, firmando la Bolla di Accompagnamento, si rende responsabile del buono stato del materiale e del quantitativo. Il compratore nel caso si verifichino rotture ed ammanchi dovrà chiedere eventuali danni o risarcimenti al vettore.

**RESI** - Per nessuna ragione l'acquirente potrà restituire il materiale senza nostra espresa preventiva autorizzazione scritta e a condizione che il materiale sia in buono stato. Tutte le spese connesse al reso autorizzato sono a carico del Committente.

In caso di reso da noi autorizzato per iscritto, di imballaggi in buono stato vuoti per grandi formati (casse e/o cavalletti), verrà riconosciuto al massimo l'80% del valore iniziale addebitato causa deperimento.

**ANNULLAMENTI** - Non verranno accettati annullamenti di ordini se il materiale e già stato prodotto o se e già stata avviata la lavorazione e molto più se e già stata effettuata la spedizione. L'annullamento dell'ordine comporterà in ogni caso l'obbligo da parte del Committente di pagare l'intera fornitura. Nel caso che sia fattibile l'accettazione dell'annullamento il Cliente sarà tassativamente tenuto a rifondere tutte le spese sostenute dal produttore ino a quel momento.

**PREZZI** - I prezzi riportati sui nostri listini non sono per noi impegnativi. Ci riserviamo il diritto di modificarli prima dell'accettazione dell'ordine.

**PAGAMENTI** - I pagamenti devono essere effettuati solo presso la nostra sede, il ritardo di oltre 10 giorni di ogni pagamento dovuto, o la mancata copertura nel termine stesso di un titolo di credito, girato o ceduto, o emesso dal committente, costituisce grado di insolvenza. In tal caso sarà nostra facoltà di sospendere le forniture ed annullare ogni rapporto in corso; immediatamente esigere l'integrale pagamento di ogni rapporto in corso; esigere l'integrale pagamento di ogni nostro credito ed agire giudizialmente al riguardo, in via esecutiva o cautelare nonché per il risarcimento danni. Decorreranno sul debito scaduto gli interessi moratori annui calcolati nella misura del tasso legale corrente maggiorato di 5 punti percentuali.

**SCONFEZIONAMENTO IMBALLI** - Non si effettuano vendite inferiori alla scatola.
**SERVIZIO CONSEGNE FINO NOSTRO DEPOSITO A MARANELLO** Il servizio presso il nostro deposito di Maranello sarà addebitato alle seguenti tariffe: da 0 a 1000 Kg € 4,00 - da 1000 a 8000 Kg 0,90 /Quintale.

**RISERVATO DOMINIO** - Il materiale anche se spedito e regolarmente fatturato resta di nostra Proprietà fino al pagamento totale della fornitura medesima anche in caso di passaggio o vendita a terzi.

I.V.A. - Il pagamento della I.V.A. dovrà pervenire comunque entro e non oltre 60 giorni dalla data di emissione della fattura.

**FORO COMPETENTE** - Per qualsiasi controversia sarà esclusivamente competente il Foro di Modena.

### FR

**AVERTISSEMENT** - Les couleurs et les caractéristiques de l'apparence des produits dans ce catalogue et dans tous les outils de merchandising sont indicatifs car ils ne peuvent pas être reproduites en version imprimée avec une fidélité absolue.

**ACCEPTATION** - Les commandes parvenues ne seront valables de manière définitive qu'après confirmation écrite de notre part.

**LIVRAISON** - La livraison du matériel s'entend au moment du chargement effectué dans nos entrepôts. Tous les risques de transport, tels que les manques, casses, détériorations ou endommagements sont à charge de l'Acheteur, même lorsque le prix convenu est franco de port, FOB ou C&F. Les accords conclus avec les transporteurs s'entendent toujours au nom et pour compte de l'Acheteur qui confirme et accepte les conditions au préalable.

**DÉLAIS DE LIVRAISON** - Les délais de livraison ont un caractère indicatif; les éventuels retards de livraisons, interruptions, suspensions totales ou partielles des marchandises ne donneront droit à aucun dédommagement ou dommages et intérêts.

**CONTESTATIONS** - La garantie de la marchandise se limite seulement et exclusivement au matériel de premier choix. Les différences de tons ne pourront être dénoncées comme vice du matériel. Les éventuelles réclamations relatives à la qualité, au type de matériel, devront nous parvenir dans les 8 jours à partir du jour de livraison. L'acheteur s'engage à mettre à disposition les parties contestées de manière à permettre le contrôle des défauts déclarés, sachant que la pose nous libère quoiqu'il en soit de toute responsabilité. Les éventuels vices ou défauts de qualité de la marchandise, si déclarés en vertu des termes de loi et confirmés ou reconnus, ne donnent droit qu'à la substitution des matériels défectueux, à condition que les marchandises contestées ne soient restituées préalablement et, sur autorisation écrite de l'opération de restitution, en renonçant et en excluant ainsi de manière formelle la résolution du contrat tout comme les éventuels dommages et intérêts.

**DIMENSIONS ET TONS** - Nos matériels se classent parmi les produits cuits à haute température et peuvent présenter en tant que tels des différences entre les dimensions déclarées et celles effectivement livrées. C'est ainsi que sont considérées les différences de tons à l'intérieur d'un même lot. C'est pourquoi, en vertu des conditions présentées précédemment, ceci ne pourra faire l'objet d'aucune réclamation de la part de l'Acheteur.

**EMBALLAGES ET QUANTITÉS** - Le bon état des emballages et de leur confection, ainsi que de la quantité livrée est confirmé après acceptation de la marchandise de la part du transporteur. Ce dernier, en signant le Bon de Livraison, se tient responsable du bon état du matériel et de la quantité. En cas de casses ou manques, l'acheteur devra demander des éventuels dommages et intérêts ou dédommagements au transporteur.

**RETOUR** - En aucun cas l'acheteur ne pourra restituer le matériel sans préalablement recevoir une autorisation écrite et expresse de notre part ; tous les frais sont à charge de l'Acheteur. En cas de retour autorisé par écrit par nos soins, pour des emballages vides en bon état destinés aux grands formats (caisses et/ou chevalets), un maximum de 80% de la valeur initiale facturée sera reconnu en raison de la dépréciation.

**ANNULLATIONS** - Aucune annulation de commandes ne sera acceptée si le matériel a déjà été produit ou si la phase de production a déjà commencé, ni même si la livraison a déjà été effectuée. L'annulation de la commande comportera dans tous les cas l'obligation de la part de l'Acheteur de payer la totalité de la marchandise. Dès lors que l'acceptation de l'annulation est faisable, le Client sera formellement tenu à supporter tous les frais soutenus par le producteur jusqu'alors.

**PRIX** - Les prix reportés sur nos catalogues ne sont pas définitifs. Nous nous réservons le droit de les modifier avant l'acceptation de la commande.

**PAIEMENTS** - Les paiements ne doivent être effectués qu'après de notre siège. Le retard de plus de 10 jours de tout paiement dû ou la non couverture dans le même délai d'un titre de crédit, transféré ou cédé, ou bien émis par l'acheteur, constitue un niveau d'insolvabilité. Dans ce cas, il est en notre pouvoir de suspendre les marchandises et annuler tout rapport en cours; d'exiger le paiement intégral et immédiat de tout rapport en cours; d'exiger le paiement intégral de tout crédit en notre faveur et d'agir judiciairement à cet égard, de manière exécutive ou préventive ainsi que pour les dommages et intérêts. Les intérêts moratoires annuels calculés en fonction du taux d'intérêt légal en vigueur majoré de 5 points de pourcentage.

**DÉSEMBALLAGES** - Aucune vente inférieure à la boîte ne peut être effectuée.

**SERVICE LIVRAISONS JUSQU'A MARANELLO** - Le service aupres nos depot de Maranello sera debite sur la base des tarifs suivants: de 0 à 1000 kg 4,00 € - de 1000 à 8000 kg 0,90 €/quintal.

**RÉSERVE DE PROPRIÉTÉ** - Le matériel, même si livré et régulièrement facturé reste notre propriété jusqu'au paiement total de ladite marchandise, même en cas de passage ou vente à un tiers.

T.V.A. - Le paiement de la T.V.A. devra parvenir quoiqu'il en soit avant et non au-delà de 60 jours à partir de la date d'émission de la facture.

**TRIBUNAL COMPETENT** - Le Tribunal de Modena sera compétent de manière exclusive en cas de litige.

### D

**WARNHINWEIS** - Die Farben und ästhetische Eigenschaften der Produkte in diesem Katalog und in allen Verkaufsfördermittel sind Richtwerte, da sie nicht in gedruckter Form mit absoluter Treue wiedergegeben werden können.

**BESTÄTIGUNG** - Eingegangene Bestellungen sind für uns nur verbindlich, wenn sie schriftlich durch uns bestätigt wurden.

**LIEFERUNG** - Die Lieferung des Materials ist für uns mit dessen Beladung bei unserem Lager abgeschlossen. Alle durch den Transport bedingten Risiken, einschlichlich Fehlmengen, Bruch, Beschädigung und sonstige Beeinträchtigungen gehen zu Lasten des Auftraggebers, auch wenn der vereinbarte Preis frachtfrei, FOB oder C&F ist. Die Vereinbarungen mit den Speditionsunternehmen werden im Namen und auf Rechnung des Auftraggebers getroffen, der die Entlastung bestätigt und erteilt.

**LIEFERFRISTEN** - Die Lieferfristen sind ungefähre Angaben; im Falle einer Verzögerung, Unterbrechung bzw. teilweiser oder kompletter

Aussetzung der Lieferungen besteht kein Recht auf Entschädigung oder Schadenersatz.

**BEANSTANDUNGEN** - Die Garantie auf die Ware bezieht sich ausschließlich auf Material erster Wahl. Unterschiede bei Farbönen können nicht als Materialfehler geltend gemacht werden. Eventuelle Beanstandungen in Bezug auf die Qualität und Materialart müssen innerhalb von 8 Tagen ab dem Lieferdatum bei uns eingehen. Der Käufer verpflichtet sich, die beanstandeten Warenpartien für die Überprüfung der angezeigten Mängel zur Verfügung zu halten. Die Verlegung des Materials befreit uns in jedem Fall von jeglicher Haftung. Eventuelle Fehler oder Qualitätsmängel der Ware, sofern disse innerhalb der gesetzlich vorgeschriebenen Fristen gemeldet, überprüft und anerkannt wurden, beinhalten lediglich das Recht auf einen Umtausch der fehlerhaften Materialien, unter der Bedingung, dass die beanstandete Ware vorher, nach schriftlicher Genehmigung der Warenrückgabe, zurückgeschickt wurde und unter Verzicht und Ausschluss des Anspruchs auf eine Vertragsauflösung oder jegliphc Art von Schadenersatz.

**ABMESSUNGEN UND FARBTONE** - Unsere Materialien sind als Produkte klassifiziert, die bei hohen Temperaturen gebrannt werden, weshalb es sein kann, dass die tatsächlichen Abmessungen von den genannten Abmessungen abweichen. Das gleiche gilt für Farbunterschiede innerhalb desselben Warenpostens. Diese Umstände geben dem Auftraggeber kein Recht zu Beanstandungen.

**VERPACKUNG UND MENGE** - Mit Annahme der Ware durch das Beförderungsunternehmen gelten der gute Zustand der Verpackungen sowie die übergebene Warenmenge als bestätigt. Das Transportunternehmen übernimmt mit Unterzeichnung des Versandscheins die Verantwortung für den guten Zustand und die Menge des Materials. Der Käufer muss sich im Fall von Brüchen oder Fehlware für eventuelle Schäden oder Entschädigungen an das Beförderungsunternehmen wenden.

**WARENRÜCKGABE** - Der Käufer kann die Ware in keinem Fall ohne unsere ausdrückliche schriftliche Genehmigung zurückgeben; alle entstehenden Kosten werden vom Auftraggeber übernommen. Im Falle einer von uns schriftlich genehmigten Rücksendung von leeren Verpackungen in gutem Zustand für Großformate (Kisten und/oder Gestelle), wird maximal 80% des ursprünglich berechneten Wertes aufgrund von Wertminderung anerkannt.

**STORNIERUNGEN** - Auftragsstornierungen werden nicht akzeptiert, wenn das Material bereits hergestellt wurde, die Produktion angelaufen ist oder die Ware gar bereits verschickt wurde. Bei der Stornierung einer Bestellung ist der Auftraggeber in jedem Fall verpflichtet, die gesamte Lieferung zu bezahlen. Falls die Stornierung akzeptiert wird, ist der Kunde verpflichtet, alle Kosten zu übernehmen, die dem Hersteller bis zu diesem Zeitpunkt entstanden sind.

**PREISE** - Die in unserer Preisliste angegebenen Preise sind für uns nicht verbindlich. Wir behalten uns das Recht vor, diese vor der Bestellungsannahme zu ändern.

**ZAHLUNG** - Die Zahlungen können nur direkt an uns erfolgen. Eine Verspätung von mehr als 10 Tagen jeder geschuldeten Zahlung bzw. die fehlende Deckung eines girierten, abgetretenen oder vom Auftraggeber ausgestellten Kreditpapiers innerhalb desselben Zeitraums wird als Zahlungsunfähigkeit gewertet. In diesem Fall haben wir das Recht, die Lieferungen auszusetzen und jedes bestehende Geschäftsverhältnis abzubrechen; unverzüglich die vollständige Zahlung jedes bestehenden Auftrags zu fordern; die vollständige Zahlung aller unserer Forderungen im Rahmen eines Vollstreckungs- oder Sicherstellungsverfahrens rechtlich zu beanspruchen, ebenso wie eine Entschädigung. Auf den fälligen Betrag werden Verzugszinsen berechnet, die auf der Grundlage des aktuellen gesetzlichen Zinssatzes, erhöht um 5 Prozentpunkte, jährlich berechnet werden.

**VERPACKUNGSGRÖSSE** - Es werden keine Mengen unterhalb der Grde eines Kartons verkauft.

**LIEFERSERVICE BIS MARANELLO** - Fuer die Lieferungen nach Lager in Maranello werden wir folgende Kosten berechnen: von 0 bis 1000 kg 4,00 € - von 1000 bis 8000 kg 0,90 €/Zentner.

**EIGENTUMSVORBEHALT** - Das Material bleibt auch bei regulärem Transport und normaler Rechnungsstellung bis zur vollständigen Bezahlung der Lieferung in unserem Eigentum, auch im Falle der Weitergabe oder des Verkaufs an Dritte.

**MEHRWERTSTEUER** - Die Zahlung der Mehrwertsteuer hat in jedem Fall bis spätestens 60 Tage nach dem Ausstellungsdatum der Rechnung zu erfolgen.

**GERICHTSSTAND** - Gerichtsstand in Streitfällen ist ausschließlIch das Gericht Modena.

# Warning instructions

Avvertenze. Instructions. Hinweise.

## General information

### SEMI-POLISHING (LAPPATURA)

A) By the process of semi-polishing the more vetrified and resistant part of the tile (top layer but also on the edges) is partially removed. In this way the porosity of the tile increases reducing the stain resistance of the tile surface.

B) There is no long lasting protective treatment or chemical coverage. but it is possible to demand for a special waterproof treatment which must be applied repeatedly.

C) We do recommend to lay down semi-polished tiles only in private housing places.

D) We do recommend to use quality raw material (glues, adhesives and grouts) and, in particular, clean water to avoid the formation of stains or marks.

E) Immediately after the laydown it is recommended to cover the entire floor with sawdust and/or something else to avoid the rubbing/cracking caused by dirty shoes or furniture moving.

F) This process (LAPPATURA) might change the tonality of the material and/or make it vary. Therefore the shading effect is quite common.

### LAPPATURA

A) La lappatura consiste nell'asportare la parte più vetrificata e resistente della piastrella, sia superficiale che laterale (seguito rettifica dei bordi). In tal modo si determina un aumento della "porosità" della superficie e una riduzione della sua capacità di protezione dalle macchie.

B) Non esiste in commercio un trattamento protettivo duraturo nel tempo. Eventualmente è possibile fornire su richiesta uno speciale trattamento impermeabilizzante che deve essere ripetuto periodicamente.

C) Si raccomanda la posa di materiale lappato solo in ambienti residenziali (privati) e comunque poco trafficati.

D) Si raccomanda, per la posa, l'utilizzo di materie prime (colla e stucchi) di prima qualità e soprattutto di acqua pulita in modo da evitare il sorgere di aloni. Si consiglia inoltre, prima della stuccatura, l'utilizzo di un prodotto idrorepellente allo scopo di agevolare la pulizia.

E) Dopo la posa si deve coprire il pavimento con segatura e/o altro, in modo da evitare lo sfregamento causato da scarpe non pulite e dalla movimentazione del mobilio in fase di arredamento.

F) Il procedimento della lappatura stonifica il materiale. Pertanto una miscelazione dei toni, tipica delle pietre naturali, è sempre presente.

### LAPPATO

A) Le traitement de surface "Lappato" (aspect pierre polie), consiste à retirer la part la plus vitrifiée et résistante du carreau - tant au niveau de sa surface qu'au niveau latéral (du fait notamment de la rectification des bords). A ce niveau, on doit constater une augmentation du taux de porosité de la surface du carreau ainsi qu'une réduction de ses facultés de protection aux taches de toutes origines.

B) Aucun traitement de protection durable dans le temp n'existe aujourd'hui sur le marché. Il peut toutefois, être possible du fournir, sur demande spécifique, un traitement spécial imperméabilisant qui doit être régulièrement réalisé.

C) Nous recommandons la pose de ces carrelages "finition Lappato", uniquement dans les seuls environnements d'habitations (appartements et maisons) résidentiels, et de faibles trafics.

D) Au niveau de leur pose, nous recommandons, l'utilisation de matières premières (colles et joints) de toute première qualité, et surtout d'eau très claire et propre, sans impuretés, de façon à éviter toute apparition de résidus à la surface qui altèreraient le contact avec celle-ci.

E) Une fois le carrelage posé, il est nécessaire de le recouvrir avec de la sciure de bois ou tout autre protection, afin d'éviter tout endommagement de la surface par des chausseurs avec des semelles sales de terre et autres pierres, ou par le déplacement de meubles lors d'emménagements dans les pièces concernées.

F) Enfin, nous vous rappelons que le procédé de la "Finition Lappato" entraîne automatiquement une "détonalisation" de l'ensemble de la surface, avec par conséquent, un mélange de différents tonalités, typique des pierres vieillies naturelles; cet aspect de tonalités mélangées doit être accepté à l'avance par le client et surtout doit faire l'objet d'une information préalable très claire de la part du vendeur.

### TEILPOLITUR

A) Die Teilpolitur besteht in der Abführung des glásigsten und widestandfähigsten Teils der Fliese, oberflächlich und seitlich (durch Rektifizierung der Kanten). Dadurch entsteht eine Steigerung der "Porosität" der Oberfläche und somit eine Schutzminderung bezüglich der Flecke.

B) Im Handel leider existiert keine daürhafte Behandlung für den Schutz ev. ist es möglich, auf Anfrage eine Wasserdicht machende Behandlung zu liefern, die aber periodisch wiederholt werden muss.

C) Die Verlegung teilpolierter Materials ist nur in Wohnbereich zu empfehlen allerdings im wenig benutzten Räumen.

D) Für die Verlegung ist die Verwendung von Stoffen (Kleber und Fugenmaterial) erster Klasse und vor allem von Reinemwasser zu empfehlen, um die Entstehung von Fleckekreisen zu vermeiden.

E) Nach der Verlegung soll der Boden mit Sägemehl oder ähnlichem gedeckt werden, um vor der Trocknung die Verkratzung durch unsaubere Schu oder durch Versatz von der Möbel zu vermeiden.

F) Das Teilpolierungsverfahren nuanciert die Fliese, daher ist eine Mischung der Töne, tipisch für Natursteine, imer gegeben.

## General index

## Product indexes

## The Company

## Product indexes

## The Company

## Product indexes

## The Company

## Product indexes

## The Company

## Product indexes

## The Company

## Product indexes

## The Company

## Product indexes

## The Company

## Product indexes

## The Company

## Product indexes

## The Company

## Product indexes

## The Company

## Product indexes

### PORCELAIN TILES IN 20 mm THICKNESS (TH2.0) FOR OUTDOOR FLOORS. RECOMMENDATIONS FOR THE INSTALLATION, CLEANING AND MAINTENANCE.

Gold Art recommends carrying out the procedures for the ordinary leaning of TH2.0 floor surfaces using water and commercially available neutral detergents: the inclination of the surface and the space between adjacent slabs for dry-system installation favour the natural flow of water.

However, it is important to take into consideration that any type of floor surface is subject to the surface tension effect of liquids: it is the same property of water that gives the tendency to transform into spherical droplets and which cause the curved top surface of a glass full of water.

The surface tension can obstacle the complete drainage of water and cause a temporary stagnation of liquid on the slab edges. In order to avoid this problem, Gold Art recommends ensuring adequate inclination of the surface during installation so as to encourage the flow of water between adjacent slabs. Should liquid deposit on the surface, it is recommended to push it towards grout lines using a brush or remove it with a wet and dry vacuum cleaner.

### TH2.0 - RACCOMANDAZIONI SULLA POSA, PULIZIA E MANUTENZIONE.

Gold Art consiglia di effettuare le operazioni di pulizia ordinaria delle superfici pavimentate con TH2.0 ricorrendo ad acqua e normali detersivi neutri: la pendenza della superficie e gli spazi tra le lastre nelle pose a secco facilitano il naturale deflusso delle acque.

Si consideri tuttavia che qualunque tipo di pavimentazione è soggetta al fenomeno della tensione superficiale dei liquidi: si tratta della stessa proprietà dell'acqua che le conferisce la tendenza a distribuirsi in gocce sferiche, o che causa la formazione della classica bombatura in un bicchiere pieno di acqua oltre il colmo.

La tensione superficiale può impedire un completo scolo dell'acqua, e causare lo stazionamento temporaneo di una patina di liquido in corrispondenza dei bordi delle lastre. Per ovviare a questo problema, Gold Art raccomanda di prevedere le opportune pendenze della superficie in fase di installazione, per facilitare il deflusso delle acque negli spazi tra le lastre. Se dovesse persistere una patina di acqua, si consiglia di spingerla verso le fughe con uno spazzolone, oppure di rimuoverla con un aspira liquidi.

### GRÉS CÉRAME EN 20 mm (TH2.0) D'ÉPAISSEUR POUR DES SOLS EXTÉRIEURS. CONSEILS SUR LA POSE, NETTOYAGE ET ENTRETIEN.

Gold Art conseille d'effectuer les opérations de nettoyage ordinaire des surfaces carrelées avec TH2.0 en utilisant de l'eau et des détergents neutres communs : l'inclinaison de la surface et les espaces entre les dalles dans les poses à sec facilitent l'écoulement naturel de l'eau.

Considérez cependant que tout type de sol est soumis au phénomène de la tension superficielle des liquides: il s'agit de la même propriété de l'eau qui lui donne la tendance à se répandre en gouttes sphériques, ou qui entraîne la formation classique de la surface bombée d'un verre d'eau rempli à ras bord.

La tension superficielle peut empêcher l'écoulement de l'eau, et causer la stagnation temporaire d'une légère patine d'eau au niveau des bords des dalles. Pour résoudre ce problème, Gold Art conseille de prévoir les pentes opportunes de la surface en phase d'installation, pour faciliter l'écoulement des eaux dans les espaces entre les dalles. Si la patine d'eau persiste, il est conseillé de la pousser vers les joints à l'aide d'une brosse à carrelage ou bien de l'éliminer avec un aspirateur à liquide.
**20 mm (TH2.0) STARKES FEINSTEINZEUG FÜR AUSSENBODENBELÄGE. EMPFEHLUNGEN FÜR DIE VERLEGUNG, REINIGUNG UND PFLEGE.**
Gold Art empfiehlt, zur normalen Reinigung der mit TH2 verlegten Flächen Wasser und normale, neutrale Reinigungsmittel zu verwenden; das Gefälle der Flächen und die im Trockenbau entstehenden Zwischenräume zwischen den Platten erleichtern das natürliche Abfließen des Wassers.

Auf jeder Art von Bodenbelag kommt es jedoch zur Oberflächenspannung der Flüssigkeiten; es handelt sich um ein Merkmal des Wassers selbst, das sich in runden Tropfen verteilt bzw. die klassische Wölbung in einem randvoll gefüllten Glas aufweist. Die Oberflächenspannung kann das vollständige Abflauen des Wassers behindern und dazu führen, dass sich vorübergehend Flüssigkeit an den Plattenrändern ansammelt.

Um dieses Problem zu vermeiden, empfiehlt Gold Art, bei der Installation für eine angemessene Neigung der Fläche zu sorgen, damit das Wasser über die Zwischenräume abflauen kann. Auf der Oberfläche stagnerendes Wasser sollte mit einer Bürste in die Zwischenräume gedrückt oder mit einem Allzsauger abgesaugt werden.

## Product indexes

# Non-slip classification

Classificazioni antiscivolo. Classification antidérapant. Trittsicherheitsklassen.





## DIN 51097 (A+B+C)

German norm regarding the determination of the anti-slip characteristics in wet areas. The used method is trampling on a plane with variable sloping. The classification of the anti-slip characteristics on wet surface includes 3 groups: A - B - C.

Norma tedesca che prevede la determinazione delle proprietà anti-scivolo in zone bagnate. Il metodo adottato è il camminamento a piedi nudi su un piano ad inclinazione variabile dove viene fatta scorrere dell'acqua. La classificazione per le caratteristiche antidrucciolo su bagnato prevede 3 gruppi: A - B (A+B) - C (A+B+C).

Norme allemande qui définit les propriétés antidérapantes des surfaces humides. La méthode de mesure se base sur le piétinement à pieds nus d'une surface où ruisselle de l'eau, selon différentes pentes. La classe antidérapage des surfaces humides se divise en 3 groupes: A, B et C.

Deutsche Norm zur Messung der Rutschfestigkeit in Nassbereichen. Die vorgesehene Methode beinhaltet das Barfußgehen auf einer schiefen Ebene mit mehr oder minder großem Neigungswinkel, auf der Wasser als Gleitmittel verwendet wird. Im Hinblick auf die rutschhemmenden Eigenschaften in Barfußbereichen wird nach 3 Bewertungsgruppen unterschieden: A - B - C.

ANGLE ANGOLO INCLINAISON WINKEL	CLASSIFICATION CLASSIFICAZIONE CLASSIFICATION BEWERTUNGSGRUPPE	INTENDED USE DESTINAZIONE D'USO UTILISATION PRÉVUE BESTIMMUNGSZWECK
 $\alpha < 12^\circ$	Unclassified Non classificato Non classé Nicht bewertet	
 $12^\circ \leq \alpha \leq 18^\circ$	<b>A</b>	Changing-rooms, barefoot access zones, etc. Spogliatoi, zone di accesso a piedi nudi, etc. Vestiaires, zones d'accès pieds nus, etc. Umkleideräume, Barfuß-Zugangsbereiche, usw.
 $18^\circ \leq \alpha \leq 24^\circ$	<b>B</b>	Showers, edges of swimming-pools, etc. Docce, bordi di piscina, etc. Douches et abords de piscines, etc. Duschen, Beckenumgänge, usw.
 $\alpha \geq 24^\circ$	<b>C</b>	Underwater sloping swimming-pool edges, submerged steps, linking troughs between pools, zones where water may stagnate. Bordi di piscine in pendenza ma sott'acqua, scale sommerse, vasche di passaggio tra una piscina e l'altra, zone dove sussiste la possibilità di acqua stagnante. Abords de piscines inclinés sous l'eau, échelles immergées, bassins de passage d'une piscine à une autre, zones à hauteur desquelles peut être présente de l'eau stagnante. Geneigte wasserbeflutete Beckenumgänge, Unterwasserteppen, Durchgangsbecken zwischen mehreren Schwimmbecken, Zonen mit möglichen Wasseranstauungen.

## ASTM C 1028

Norm valid for the U.S.A. including the measurement of the static friction coefficient in dry and wet surface conditions using a neolite-coated sliding device on which a 50-pound load is applied. The indexes of the static friction coefficient are the following:

Normativa valida per gli U.S.A. che prevede la misura del coefficiente di attrito statico sia in condizioni di superficie asciutta che bagnata utilizzando un dispositivo scivolante rivestito di neolite su cui agisce un carico di 50 libbre. Gli indici di coefficiente di attrito statico sono i seguenti:

Norme de référence des États-Unis qui définit le coefficient de friction statique sur des surfaces sèches ou humides, en utilisant un dispositif glissant revêtu de néolite sur lequel agit une charge de 50 livres. Les indices du coefficient de friction statique sont les suivants:

US-Norm zur Messung des statischen Reibkoeffizienten auf trockener sowie nasser Oberfläche anhand einer gleitenden, neolitbeschichteten und mit 50 Pfund beschwerten Vorrichtung. Die statischen Reibbeiwerte sind:

$\leq 0,50$	0,50 ÷ 0,60	$\geq 0,60$
Dubious slip resistance Attrito contestabile Coefficient de friction contestable Beanstandbare Reibung	Ineffective slip resistance Attrito non anti-scivolo Coefficient de friction non antidérapant Keine Antirutsch-Reibung	Slip resistant Attrito anti-scivolo Coefficient de friction antidérapant Antirutsch-Reibung







## DIN 51130 ANTISCIVOLOSITÀ R

R ANTI-SLIP = German norm measuring the determination of anti-slip resistance for working and operating place floors with slippery surfaces. The used method is trampling on a plane with variable sloping. The classification of the anti-slip characteristics includes 5 groups: R9-R10-R11-R12-R13.

Normativa tedesca che misura le determinazione della resistenza allo scivolamento per pavimentazioni di ambienti di lavoro e zone operative con superfici sdrucciolevoli Il metodo adottato è il calpestio su un piano ad inclinazione variabile. La classificazione per le caratteristiche antidrucciolo prevede 5 gruppi: R9-R10-R11-R12-R13.

ANTIDÉRAPAGE R = norme allemande qui détermine la résistance au dérapage des carrelages destinés aux lieux de travail et zones où des surfaces antidérapantes sont requises. La méthode de mesure adoptée est le piétinement de surface selon différentes pentes. La classe antidérapage se divise en 5 groupes: R9, R10, R11, R12 et R13.

RUTSCHFESTIGKEIT R = Deutsche Norm zur Messung der Rutschfestigkeit von Fußböden in Arbeitsräumen und -bereichen mit rutschigen Oberflächen. Die vorgesehene Methode beinhaltet das Gehen auf einer schiefen Ebene mit mehr oder minder großem Neigungswinkel. Im Hinblick auf die rutschhemmenden Eigenschaften wird nach 5 Bewertungsgruppen unterschieden: R9-R10-R11-R12-R13.

ANGLE ANGOLO INCLINAISON WINKEL	CLASSIFICATION CLASSIFICAZIONE CLASSIFICATION BEWERTUNGSGRUPPE	INTENDED USE DESTINAZIONE D'USO UTILISATION PRÉVUE BESTIMMUNGSZWECK
 $\alpha < 6^\circ$	Unclassified Non classificato Non classé Nicht bewertet	
 $6^\circ \leq \alpha \leq 10^\circ$	<b>R9</b>	Entrances and staircases with outdoor access. Restaurants and canteens, shops, clinics, hospitals, school. Zone ingresso e scale con accesso dall'esterno. Ristoranti e mense, negozi, ambulatori, ospedali, scuole. Zones d'entrée et escaliers avec accès de l'extérieur. Restaurants et cantines, magasins, cabinets de consultation, hôpitaux et écoles. Eingangsbereiche und Treppen mit Zugang von außen. Restaurants und Kantinen, Geschäfte, Praxen, Krankenhäuser, Schulen.
 $10^\circ \leq \alpha \leq 19^\circ$	<b>R10</b>	Communal bathrooms and showers, small kitchens and catering outlets, garages and basements. Bagni e docce comuni, piccole cucine ed esercizi per la ristorazione, garage e sotterranei. Toilettes et douches communes, petites cuisines pour l'exercice de la restauration, garages et sous-sols. Badezimmer und Gemeinschaftsduschen, kleine Kücken und Betriebe für die Restauration, Garagen und Untergeschoße.
 $19^\circ \leq \alpha \leq 27^\circ$	<b>R11</b>	Food production facilities. Medium-sized restaurant kitchens. Working environments with large amounts of water and mud, laboratories, laundries and hangars. Ambienti per la produzione di generi alimentari. Medie cucine di esercizi per la ristorazione. Ambienti di lavoro con forte presenza acqua e fanchiglia, laboratori, lavanderie, hangar. Locaux pour la production de denrées alimentaires. Cuisines de dimensions moyennes pour l'exercice de la restauration. Lieux de travail avec forte présence d'eau et de boue, laboratoires, teintureries et hangars. Lebensmittelproduktionsbereiche. Mittelgroße Kücken für Restaurationsbetriebe. Arbeitsbereiche mit stark vorhandenem Wasser und Schlamm, Labors, Wäschereien, Hangars.
 $27^\circ \leq \alpha \leq 35^\circ$	<b>R12</b>	Environments for the production of high-fat foods such as dairy products, oils and cured meats. Large restaurant kitchens. Industrial facilities making products using slippery substances. Car parks. Ambienti per la produzione di alimenti ricchi di grassi come latticini e derivati, olii e salumi. Grandi cucine per la ristorazione. Preparati industriali con impiego di sostanze scivolose. Parcheggi auto. Locaux pour la production de denrées alimentaires riches en matières grasses telles que charcuteries et huiles. Grandes cuisines pour l'exercice de la restauration. Ateliers industriels avec emploi de sustances glissantes. Parcs de stationnement autos. Bereiche für die Produktion fettreicher Lebensmittel wie Milchprodukte und milchnebenprodukte, Öle und Wurstwaren. Großküchen für die Restauration. Industrielle Zubereifungen mit Einsatz rutschiger Stoffe. Autoparkplätze.
 $\alpha \geq 35^\circ$	<b>R13</b>	Environments with large quantities of fats and grease. Food processing. Ambienti con grossa quantità di grassi. Lavorazione degli ambienti. Locaux avec grande quantité de graisses. Locaux de transformation des aliments. Bereiche mit großen Fettmengen. Lebensmittelbearbeitung.

General index

Product indexes

The Company

Collections

TH2.0  
Outdoor Solutions

Bathroom furniture

Ventilated facades

Technical information

Energieker

2025 Surfaces Collection

Technical information

















# Technical specifications of porcelain

Conforming to european standards en 14411 appendice g gruppo Bla con e ≤ 0,5 %

Caratteristiche tecniche Gres porcellanato - conformi a norme europea en 14411 appendice G gruppo Bla con e ≤ 0,5 %

Caracteristiques techniques du grès cérame - conformes aux normes européennes EN 14411 appendice G groupe Bla con e ≤ 0,5 %

Technische eigenschaften für feinsteinzeug - gemäß den europäischen normen EN 14411 appendice G gruppo Bla con e ≤ 0,5 %

PHYSICAL PROPERTIES CARATTERISTICA TECNICA CARACTERISTIQUE TECHNIQUE TECHNISCHEDATEN	TESTING METHOD METODO DI PROVA NORME D'ESSAIS PRÜFVERFAHREN	REFERENCE STANDARD RIFERIMENTO NORMA REFERENCE NORME STANDARDWERT	PRODUCT VALUES VALORE PRODOTTO VALEUR PRODUIT PRODUKT WERTE				
			7cm ≤ N < 15 cm (mm)	N ≥ 15 cm (%) (mm)		Natural not rectified	Rectified and high gloss LCP
 <b>Sizes</b> Dimensioni Dimensions Abmessungen	EN ISO 10545-2		<b>Length and width</b> / Lunghezza e larghezza Longuer et largeur / Länge und Breite	±0.9	±0.6	±2.0	
			<b>Tickness</b> / Spessore / Epaisseur / Stärke	±0.5	±5.0	±0.5	
			<b>Linearity</b> / Rettineità spigoli Rectitude des arêtes / Kantengeradheit	±0.75	±0.5	±1.5	
			<b>Wedging</b> / Ortogonalità / Orthogonalité / Recktwindigkeit	±0.75	±0.5	±2.0	<b>Conforming</b> Conforme Conforme Erfüllt
			<b>Warpage</b> / Planarità / Planéité / Ebenflächigkeit	±0.75	±0.5	±2.0	<b>Conforming</b> Conforme Conforme Erfüllt
			<b>Appearance: percentage of acceptable tiles, per lot</b> Aspetto: percentuale di piastrelle accettabili nel lotto Aspect: pourcentage de carreaux acceptables sur la fourniture totale Oberflächenbeschaffenheit: Prozentsatz der Fliesen, die den geforderten Eigenschaften entsprechen	95 % min.	95 % min.	-	
 <b>Water absorption %</b> Assorbimento d'acqua % Absorption deau % Wasseraufnahme %	EN ISO 10545-3	E ≤ 0,5% (individual value Max. 0,6%)					<b>Conforming</b> Conforme Conforme Erfüllt
 <b>Conforming</b> Conforme Conforme Erfüllt	EN ISO 10545-4	medium value ≥ 35 N/mm <sup>2</sup> (individual value Min. 32 N/mm <sup>2</sup> )					<b>Conforming</b> Conforme Conforme Erfüllt
 <b>Breakage resistance</b> Sforzo di rottura Résistance à la rupture Bruchlast		sp. ≤ 7,5 mm: min 700 N sp. ≥ 7,5 mm: min 1300 N					<b>Conforming</b> Conforme Conforme Erfüllt
 <b>Scratch resistance</b> Resistenza all'abrasione profonda Résistance à l'abrasion Bestimmung des Widerstandes gegen tiefen Verschleib	EN ISO 10545-6	175 mm <sup>3</sup> max.					<b>Average / Medio</b> Moyenne / Mittelwert < 175 mm <sup>3</sup>
 <b>Abrasion resistance</b> Resistenza all'abrasione Résistance à l'abrasion Widerstand gegen Verschleiss	EN ISO 10545-7	<b>Required</b> Richiesta Requise Gefordert					II - V
 <b>Thermal expansion coefficient</b> Coefficiente di dilatazione termica lineare Coefficient de dilatation thermique linéaire Wärmeausdehnung	EN ISO 10545-8	<b>Declared value</b> Valore dichiarato Valeur déclaré Angegebenwert					6,5x10 <sup>-6</sup> °C
 <b>Thermal shock resistance</b> Resistenza agli sbalzi termici Résistance aux écarts de température Temperaturwechselbeständigkeit	EN ISO 10545-9	<b>Pass according to iso 10545-1</b> Test superato in accordo con iso 10545-1 Pv en accord avec norme en 10545-1 Test ueberstanden nach ISO 10545-1					<b>Resistant</b> Resistente Résistants Widerstandsfähig
 <b>Frost resistance</b> Resistenza al gelo Résistance au gel Frostbeständigkeit	EN ISO 10545-12	<b>Pass according to iso 10545-1</b> Test superato in accordo con iso 10545-1 Pv en accord avec norme en 10545-1 Test ueberstanden nach ISO 10545-1					<b>Resistant</b> Resistente Résistants Widerstandsfähig
 <b>Resistance to low concentrations of acids and alkali</b> Resistenza a basse concentrazioni di acidi e alcali Résistance à des basses concentrations d'acides et bases Beständigkeit gegen schwach konzentrierte Säuren und Laugen		<b>Declared value</b> Valore dichiarato Valeur déclaré Angegebenwert					<b>See single tile picture</b> Vedi il minimale Voir sous du carreau photo Siehe einzelnen Abbildungen
 <b>Resistance to high concentrations of acids and alkali</b> Resistenza ad alte concentrazioni di acidi e alcali Résistance à des hautes concentrations d'acides et bases Beständigkeit gegen stark konzentrierte Säuren und Laugen	EN ISO 10545-13	<b>Declared value</b> Valore dichiarato Valeur déclaré Angegebenwert					<b>See single tile picture</b> Vedi il minimale Voir sous du carreau photo Siehe einzelnen Abbildungen
 <b>Resistance to domestic chemicals and additives for swimming pools</b> Resistenza ai prodotti chimici di uso domestico e agli additivi per piscina Résistance aux prod. chimiques d'usage domestique et additifs pour piscines Beständigkeit gegen chemische Haushaltsreiner und Zusatzstoffe für schwimmbäder		B min.					<b>See single tile picture</b> Vedi il minimale Voir sous du carreau photo Siehe einzelnen Abbildungen
 <b>Color resistance to light</b> Resistenza dei colori alla luce Résistance des couleurs à la lumière Lichtbeständigkeit	DIN 51094	<b>No noticeable color change</b> Non devono presentare apprezzabili variazioni di colore Ne doivent pas présenter de variations importantes des couleurs Die Muster dürfen keine sichtbaren Farbveränderungen aufweisen					<b>No alteration after testing</b> Materiale inalterato dopo il test Aucune altération relevée Keine Veränderung nach dem Test
	EN 16165						<b>See single tile picture</b> / Vedi il minimale Voir sous du carreau photo / Siehe einzelnen
	DIN 51097						<b>See single tile picture</b> / Vedi il minimale Voir sous du carreau photo / Siehe einzelnen
 <b>Friction coefficient (slipperiness)</b> Coefficiente di attrito (Scivolosità) Coefficient de friction (Glissement) Reibungskoeffizient (Schlupfrigkeit)	B.C.R.A. D.M.236/ 89	<b>If needed</b> Dove richiesto Si demande Nach Anforderung					<b>Available test</b> / Test disponibile Essai disponible / Pruefzeugnis verfügbar
	ASTM C1028-2007						<b>Available test</b> / Test disponibile Essai disponible / Pruefzeugnis verfügbar
	ANSI A 137.1-2012						<b>See single tile picture</b> / Vedi il minimale Voir sous du carreau photo / Siehe einzelnen
							<b>Available test</b> / Test disponibile Essai disponible / Pruefzeugnis verfügbar

It's advisable to refer Technical Division for all necessary guidelines to a correct use. Si raccomanda di consultare Technical Division per le indicazioni necessarie al corretto utilizzo. Merci de consulter notre Technical Division pour les indications a un usage correct. Zur korrekten anwendung wird empfohlen unsere Technical Division zu kontaktieren.

Technical details available on: [www.energieker.it](http://www.energieker.it) Schede tecniche consultabili sul sito: [www.energieker.it](http://www.energieker.it)  
Technisches Datenblatt auf der Website: [www.energieker.it](http://www.energieker.it). Fiches techniques à consulter sur le syte: [www.energieker.it](http://www.energieker.it)

# Weights and measures table

Pesi e misure. Tableau poids et mesures. Gewichts- und Maßtabelle.

Size Formato Format Format	Thickness Spessore Épaisseur Stärke	Pcs/Box Pz/Scatola Stk/Karton Pieces/Boîte	Sqm/Box Mq/Scatola Qm/Karton M <sup>2</sup> /Boite	Kg/Box Kg/Scatola Kg/Karton Kg/Boite	Box/Pallet Scatola/Pallet Karton/Palette Boite/Palette	Sqm/Pallet Mq/Palette Qm/Palette M <sup>2</sup> /Palette	Kg/Pallet Kg/Pallet Kg/Palette Kg/Palette	
9,9x30,2	RETT	9	0,78	14,50	60	46,80	873	
9,5x57	RETT CHEVRON	9	0,76	13,93	48	36,48	688,64	
15x30	CAMPIGIANE / ANTICHI AMORI	9,2	1,26	25,00	60	75,60	1.520	
15x30		8,2	1,44	25,00	60	86,40	1.400	
20x20		7,2	38	1,52	24,33	60	91,20	1.480
20x40		8,2	20	1,60	28	48	76,80	1.360
20x120	RETT *	9	5	1,20	22,70	48	57,60	1.100
	RETT *	6	7	1,68	24,19	48	80,64	1.181
30x30	CAMPIGIANE / ANTICHI AMORI	9,2	14	1,26	25,33	60	75,60	1.540
30x120	RETT *	9	4	1,44	28,60	39	56,16	1.130
	RETT *	6	6	2,16	31,10	36	84,24	1.232
30x60	RETT	9	7	1,26	24,38	40	50,40	960
	LCP / RST	9	7	1,26	24,38	40	50,40	1.050
30,8x61,5		9	7	1,32	24,88	40	52,80	920
60x60	RETT / RST / LCP	9	4	1,44	28,57	30	43,20	812
	RETT / RST / LCP *	9	2	1,44	28,57	35	50,40	1.020
	RETT *	6	3	2,16	31,10	35	75,6	1.108
80x80	RETT/LCP	9	2	1,28	25,58	45	57,60	1.171
20x20	BICOTTURA	6,5	40	1,60	16,56	72	115,20	1.212
20x50	BICOTTURA	8	14	1,40	19,45	60	84	1.187
20x50	DECORO BICOTTURA	8	14	1,40	18,83	60	84	1.150

Size Formato Format Format	Thickness Spessore Épaisseur Stärke	Packaging Tipologia imballaggio Typologie de l'emballage Verpackungsarten	Packaging size Ingombro Dimension Format	Pcs/Box Pz/Scatola Stk/Karton Pieces/Boîte	Sqm/Box Mq/Scatola Qm/Karton M <sup>2</sup> /Boite	Kg/Box Kg/Scatola Kg/Karton Kg/Boite	Box/Pallet Scatola/Pallet Karton/Palette Boite/Palette	Sqm/Pallet Mq/Palette Qm/Palette M <sup>2</sup> /Palette	Kg/Pallet Kg/Pallet Kg/Palette Kg/Palette
120x120	RETT	Pallet with sides	143,2x124x56,1	2	2,88	61,36	18	51,84	1.020
	LCP/RST **	Pallet with sides	143,2x124x56,1	2	2,88	61,36	18	51,84	1.056
20x160	RETT **	Pallet with sides	168x97x57	4	1,28	25,57	36	46,08	970
30x160	RETT **	Pallet with sides	168x97x57	3	1,44	28,77	30	43,20	913
	RETT **	Pallet with sides	168x97x57	4	1,92	27,65	30	57,60	850
80x160	RETT/LCP **	Pallet with sides	168x97x57	2	2,56	51,15	18	46,08	970

## EKXTREME - TOP SOLUTION

Size Formato Format Format	Thickness Spessore Épaisseur Stärke	Packaging Tipologia imballaggio Typologie de l'emballage Verpackungsarten	Packaging size Ingombro Dimension Format	Sqm/Pcs Mq/Pz Qm/Stk M <sup>2</sup> /Pieces	Kg/Pcs Kg/Pz Kg/Stk Kg/Pieces	Pcs/Pal Stk/Pal Pieces/Pal	Sqm/Crate - A frame Mq/Cassa - Cavalletto Qm/Caisse - Chevalet M <sup>2</sup> /Kiste - Ständer	Kg/Crate - A frame Kg/Cassa - Cavalletto Kg/Caisse - Chevalet Kg/Kiste - Ständer
120x280	RETT/LCP ***	Crate	291x140x34	3,36	48,38	20	67,20	1.054
	RETT/LCP ***	A frame	290x75x156	3,36	48,38	44	147,84	2.252
160x320	RETT/LCP ***	Crate	172,6x343,2x36	5,12	72,50	16	81,92	1.292
	RETT/LCP ***	A frame	330x75x200	5,12	72,50	40	204,80	3.086
163x324	SILK/LCP ***	Crate	172,6x343,2x36	5,28	146	8	42,24	1.300
	SILK/LCP ***	A frame	330x75x200	5,28	146	20	106,60	3.106
163x324	SILK / LCP ***	Crate	172,6x343,2x36	5,28	245	6	31,68	1.570
	SILK / LCP ***	A frame	330x75x200	5,28	245	12	63,36	3.090

## TH2.OUTDOOR SOLUTIONS

Size Formato Format Format	Thickness Spessore Épaisseur Stärke	Pcs/Box Pz/Scatola Stk/Karton Pieces/Boîte	Sqm/Box Mq/Scatola Qm/Karton M <sup>2</sup> /Boite	Kg/Box Kg/Scatola Kg/Karton Kg/Boite	Box/Pallet Scatola/Pallet Karton/Palette Boite/Palette	Sqm/Pallet Mq/Palette Qm/Palette M <sup>2</sup> /Palette	Kg/Pallet Kg/Pallet Kg/Palette Kg/Palette
120x120	RETT **	1	1,44	66,02	18	25,92	1.220
30x120	RETT *	2	0,72	32,44	36	25,92	1.188
80x80	RETT	1	0,64	28,60	45	28,80	1.307
60x120	RETT *	2	0,72	32,33	30	21,60	980
60x90	RETT	2	1,08	48,28	27	29,16	1.323
60x60	RETT	2	0,72	32,07	30	21,60	965

\* **WARNING: Storage up to maximum 3 stacked pallets . ATTENZIONE,** sovrapporre max 3 palette alla volta . **FAIRE ATTENTION!** Le materiel peut etre empilé par 3 palettes à la fois maximum . **ACHTUNG,** max. 3 Paletten stapeln.

\*\* **WARNING: Storage up to maximum 4 stacked pallets . ATTENZIONE,** sovrapporre max 4 palette alla volta . **FAIRE ATTENTION!** Le materiel peut etre empilé par 4 palettes à la fois maximum . **ACHTUNG,** max. 4 paletten stapeln.

\*\*\* **WARNING: Storage up to maximum 8 stacked crates . ATTENZIONE,** sovrapporre max 8 casse alla volta . **FAIRE ATTENTION!** Le materiel peut etre empilé par 8 caisses à la fois maximum . **ACHTUNG,** max. 8 Verpackungskisten stapeln.



# Packaging

Tipologie di imballaggio . Typologie de l'emballage . Verpackungsarten.

## A-Frame - Cavalletto - Chevalet - Ständer

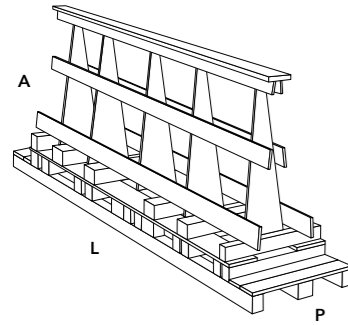

L: **330** x P: **75** x A: **200** cm - € 280

**Slab Size** - Formato lastre - Dimension des dalles - Plattenformat: **163x324 - 160x320**

L: **290** x P: **75** x A: **156** cm - € 240

**Slab Size** - Formato lastre - Dimension des dalles - Plattenformat: **120x280**

## Crate - Cassa - Caisse - Kiste

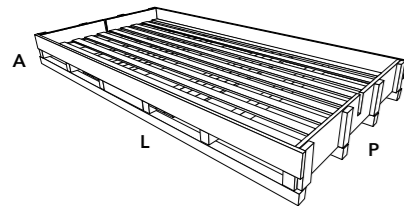

L: **343,2** x P: **172,6** x A: **36** cm - € 190

**Slab Size** - Formato lastre - Dimension des dalles - Plattenformat: **163x324 - 160x320**

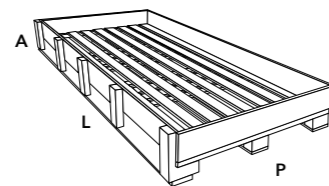

**Crate - 20 Pc:**

L : **291** x P : **140** x A : **34** cm - € 130

**Slab Size** - Formato lastre - Dimension des dalles - Plattenformat: **120x280**

**Crate - 10 Pc:**

L : **292** x P : **132** x A : **21** cm - € 70

**Slab Size** - Formato lastre - Dimension des dalles - Plattenformat: **120x280**

## Pallet with sides - Pallet con sponde - Palettes - Paletten Gestell

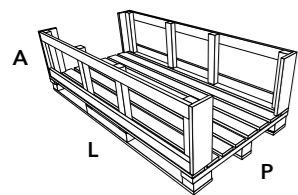

L: **168** x P: **97** x A: **57** cm - € 50

**Slab Size** - Formato lastre - Dimension des dalles - Plattenformat: **80x160 - 30x160 - 20x160**

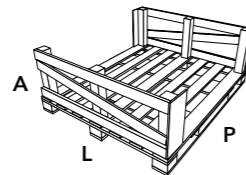

L: **143,2** x P: **124** x A: **56,1** cm - € 30

**Slab Size** - Formato lastre - Dimension des dalles - Plattenformat: **120x120**

**Special picking packaging is available for less than 10 pcs.**

Per imballi contenenti un numero di scatole minori di 10 sono previsti anche degli imballi speciali.  
Pour les emballages contenant un nombre de boîtes inférieur à 10, ils sont prévus aussi de conditionnements spéciaux.  
Lieferungen von weniger als 10 Kartons werden in Speziellen Verpackungen geliefert.

# Loading composition

Composizioni di carico . Composition du chargement . Zusammenstellung der ladung

<b>Truck</b> . Camion bilico . Camion avec semi - remorqu . LWK 13,6m x 2,5m		m <sup>2</sup>	Weight Peso Poids Gewicht
Full 120x120 (9 mm)	Nr. 27 Pallet including 18 pcs each – remain 10 free spaces for standard europallet (80x120) Nr. 27 Palette da 18 sc - rimangono nr 10 spazi per europallet (80x120)	1.399,68	29.754
Full 120x280 (6 mm)	Nr. 20 Crates including 20 pcs each – remain 8 free spaces for standard europallet (80x120) Nr. 20 Casse da 20 pz - rimangono nr 8 spazi per europallet (80x120)	1.344	21.140
Full 160x320 (6 mm)	Nr. 15 Crates including 16 pcs each Nr. 15 Casse da 16 pz	1.228,80	19.380
	Nr. 9 A-frame including 40 pcs each Nr. 9 Cavalletti da 40 pz	1.843,20	27.774
Full 164x324 (12 mm)	Nr. 15 Crates including 8 pcs each Nr. 15 Casse da 8 pz	633,60	19.500
	Nr. 9 A-frame including 20 pcs each Nr. 9 Cavalletti da 20 pz	950,40	27.954

<b>20 Feet Container</b> . Container 20 piedi . Conteneur 20 pieds . 20-Fuss-Container		m <sup>2</sup> w	Weight Peso Poids Gewicht
Full 120x120 (9 mm)	Nr. 16 Pallet including 18 pcs each + nr. 4 A-frame including 18 pcs each Nr. 16 Palette da 18 sc + nr 4 cavalletti da 18 sc	1.051,12	22.180
Full 120x280 (6 mm)	A Nr. 12 Crates including 20 pcs each Nr. 12 Casse da 20 pz	806,40	12.720
	B Nr. 6 A-frame including 44 pcs each Nr. 6 Cavalletti da 44 pz	887,04	13.512
	C Nr. 12 Crates including 20 pcs each + nr. 2 A-frame including 44 pcs each Nr. 12 Casse da 20 pz + nr 2 cavalletti da 44 pz	1102,08	17.152
Full 160x320 (6 mm)	A Nr. 5 Crates including 16 pcs each – remain 5 free spaces for standard europallet 80x120 Nr. 5 Casse da 16 pz - rimangono nr 5 spazi per europallet 80x120	409,60	6.460
	B Nr. 3 A-frame including 40 pcs each – remain 5 free spaces for standard europallet 80x120 Nr. 3 Cavalletti da 40 pz - rimangono nr 5 spazi per europallet 80x120	614,40	9.258
Full 164x324 (12 mm)	A Nr. 5 Crates including 8 pcs each – remain 5 free spaces for standard europallet 80x120 Nr. 5 Casse da 8 pz - rimangono nr 5 spazi per europallet 80x120	211,20	6.500
	B Nr. 3 A-frame including 20 pcs each – remain 5 free spaces for standard europallet 80x120 Nr. 3 Cavalletti da 20 pz - rimangono nr 5 spazi per europallet 80x120	316,80	9.318

<b>40 Feet Container</b> . Container 40 piedi . Conteneur 40 pieds . 40-Fuss-Container		m <sup>2</sup>	Weight Peso Poids Gewicht
Full 120x120 (9 mm)	A Nr. 24 Pallet including 18 pcs each Nr. 24 Palette da 18 sc	1.261,44	26.467
Full 120x280 (6 mm)	A Nr. 24 Crates including 20 pcs each Nr. 24 Casse da 20 pz	1.612,80	25.440
	B Nr. 11 A-frame including 44 pcs each + Nr. 1 A-frame including 35 pcs each Nr. 11 Cavalletti da 44 pz + Nr. 1 Cavalletto da 35 pz	1.743,84	26.588
	C Nr. 17 Crates including 20 pcs each + Nr. 3 A-frame including 44 pcs each + Nr. 1 A-frame including 35 pcs each Nr. 17 Casse da 20 pz + Nr. 3 cavalletti da 44 pz + Nr. 1 Cavalletto da 35 pz	1.703,52	26.500
	D Nr. 24 Crates including 20 pcs each + nr. 1 A-frame including 25 pcs each Nr. 24 Casse da 20 pz + nr 1 cavalletti da 25 pz	1.696,80	26.507
Full 160x320 (6 mm)	A Nr. 15 Crates including 16 pcs each – remain 2 free spaces for standard europallet 80x120 Nr. 15 Casse da 16 pz - rimangono nr 2 spazi per europallet 80x120	1.228,80	19.380
	B Nr. 8 A-frame including 40 pcs each – remain 3 free spaces for standard europallet 80x120 Nr. 8 Cavalletti da 40 pz - rimangono nr 3 spazi per europallet 80x120	1.638,40	24.688
Full 164x324 (12 mm)	A Nr. 15 Crates including 8 pcs each – remain 2 free spaces for standard europallet 80x120 Nr. 15 Casse da 8 pz - rimangono nr 2 spazi per europallet 80x120	633,60	19.500
	B Nr. 8 A-frame including 20 pcs each + nr. 1 A-frame including 12 pcs Nr. 8 Cavalletti da 20 pz + nr. 1 cavalletto da 12 pz	908,16	26.786

**Should you fit multiple sizes packing, please contact us in order to maximize the best composition (max sqmts load).**

Per carichi misti tra vari formati contattare l'azienda per la soluzione migliore.  
Pour tout chargement en mélange avec différents formats, contactez s'il vous plaît l'usine à fin de trouver la solution la plus adaptée.  
Bei Verladungen von verschiedenen Formaten wenden Sie sich an das Unternehmen, um die beste Lösung zu erfragen.



# Packaging handling

Movimentazione degli imballi . Manipulations des emballages . Verpackungsarten.

**For a correct and safe handling of crates, A-frame and pallets, it is recommended to use a forklift with a capacity of 5 tons and with forks at least 250 cm long.**

Per una corretta e sicura movimentazione di casse, cavalletti e pallet si raccomanda l'utilizzo di un carrello elevatore con portata di 50 quintali e con forche di lunghezza pari almeno 250 cm.

Pour une manipulation correcte et sécurisée des caisses, des tréteaux et des palettes, nous recommandons l'utilisation d'un chariot élévateur avec une capacité de 50 quintaux et avec des fourches d'une longueur d'au moins 250 cm.

Für eine korrekte und sichere Handhabung von Kisten, Böcken und Paletten empfehlen wir die Verwendung eines Gabelstaplers mit einer Kapazität von 50 Doppelzentner mit Gabeln einer Länge von mindestens 250 cm.



**Long side grip**  
Preso lato lungo  
Prise par le côté long  
Lange seite

**Fork length**  
Lunghezza forche  
longueur des fourches  
gabellänge

180 cm

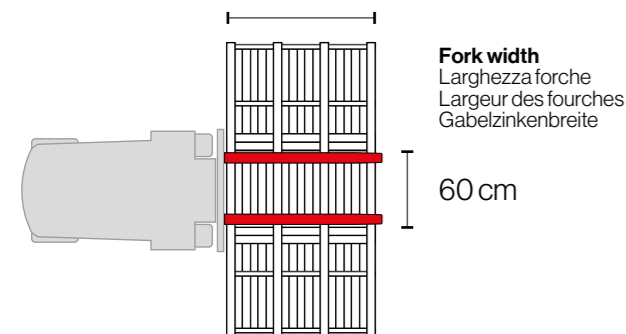

**Short side grip**  
Preso lato corto  
Prise par le côté court  
Kurze seite

**Fork width**  
Larghezza forche  
Largeur des fourches  
Gabelzinkenbreite

60 cm

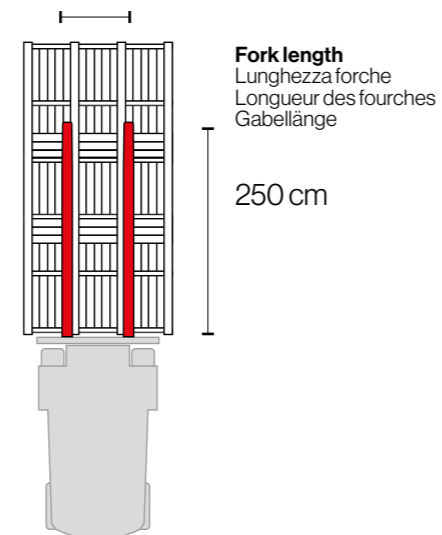

**Suction cups are absolutely necessary for the handling of each slab and, where appropriate, a trolley can also be used.**

Per la movimentazione di lastre singole sono assolutamente necessari degli organi di presa a ventose ed eventualmente anche un carrello con ruote per il trasporto.

La manipulation des plaques individuelles nécessite impérativement de dispositifs dotés de ventouses et éventuellement aussi un chariot avec des roues pour en faciliter le transport.

Zur Handhabung von Einzelplatten sind Greifvorrichtungen mit Saugnäpfen und möglicherweise auch ein Wagen mit Rädern für den Transport nötig.

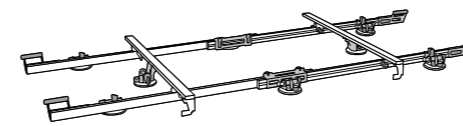

**Handling frame equipped with suction cups**  
Telaio di movimentazione dotato di ventose  
Châssis doté de ventouses  
Transportrahmen mit Saugnäpfen

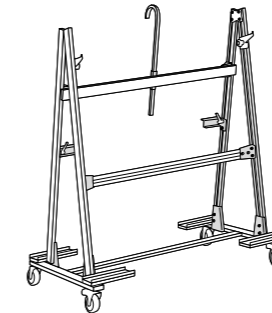

**Wheeled trolley**  
Carrello con ruote  
Chariot à roues  
Rollgestell

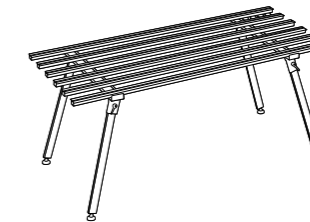

**Working table**  
Banco da lavoro  
Table de travail  
Arbeitstisch

**In addition, the dimensions of the slabs require great caution and attention in all movements. For the 160x320 format the presence of four operators at the same time is compulsory and the slabs must be handled on the long side, in order to avoid bumps or excessive bending.**

Inoltre, le elevate dimensioni delle lastre richiedono grande cautela e attenzione in tutti gli spostamenti. Per il formato 160x320 è necessaria la presenza di quattro operatori contemporaneamente e la movimentazione della lastra deve sempre seguire il lato lungo, al fine di evitare urti o eccessive flessioni.

De plus, les dimensions élevées des dalles exigent beaucoup de prudence et d'attention dans tous les mouvements. Pour le format 160x320 est nécessaire la présence de quatre opérateurs à la fois et le mouvement de la plaque doit toujours suivre le côté long, à fin d'éviter des chocs ou une flexion excessive.

Außerdem erfordern die Dimensionen dieser Platten bei allen Bewegungen große Vorsicht und Aufmerksamkeit. Für das Format 160x320 sind zur Vermeidung großer Biegungen stets 4 Personen zur Bewegung oder Umlagerung der Platten notwendig und eine Umlagerung sollte immer mit entsprechender Unterstützung der langen Seite erfolgen.

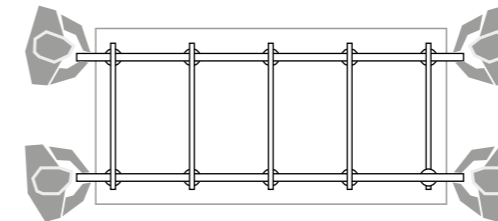

**The dimensions and weight of the EKXTREME line require specific safety measures to allow operators to work safely and to avoid any possible breakages of the slabs.**

Dimensioni e peso dei formati della gamma **EKXTREME** richiedono apposite misure di sicurezza per consentire agli operatori di lavorare senza pericoli, evitando così possibili rotture delle lastre stesse.

Les dimensions et poids de la gamme **EKXTREME** nécessitent des mesures de sécurité spécifiques pour permettre aux opérateurs de travailler sans risques, évitant ainsi de possibles ruptures de plaques.

Maße und Gewichte der **EKXTREME**-Reihe erfordern spezifische Sicherheitsmaßnahmen damit die Bediener gefahrlos arbeiten können und ein eventueller Plattenbruch vermieden wird.

# Warning instructions EKXTREME

Avvertenze EKXTREME. Instructions EKXTREME. Hinweise EKXTREME.

## RECEIPT OF GOODS

- Check that the goods received tally with what is stated on the delivery document and the order.
- Check that the package is intact externally (no blows or visible signs of wear).
- Open the package and check at least the first slab (shade, appearance, quality class, size), as well as the condition of the material (the slabs must be handled according to the instructions provided).
- Please note that once laid, no claims can be laid concerning the appearance of the material (non-compliance) or for obvious defects.

### HANDLING

Significant and/or accidental blows can cause breakages in the material. Multiple slabs can only be stored and handled one on top of the other if they are the same size. Make sure that the slab (or part of it) is not placed on cut slabs or smaller scraps and always check that there are no spaces or gaps in the supporting surface/structure. Do not place other materials on top of the slabs. Take care during throughout the handling to prevent blows that could cause chipping and/or breakage of the slabs. During handling, each individual slab must be gripped carefully, with the gripper positioned centrally, and in compliance with the weight limits stated by the machine. When holding several slabs using a lifting beam, use the canvas sling with a cut-proof rubber cover, positioning the slabs carefully spaced apart and taking the necessary precautions. A wooden spacer (larger than the packet of slabs) should be placed at the bottom and at the top, against which the slings will rest so that the weight and tension are not exerted directly onto the slabs. Do not use steel cables or chains that could damage the surface and edges. The pieces obtained from processing can be sharp and must therefore be handled with care, using appropriate PPE.

When handling individual slabs (including those without holes,) movements must always be made with the slab upright. The cut material must be packed in crates equipped with protection for the corners and suitably thick shock-absorbing panels around the edges to protect the material in the event of a blow. Inadequate packaging of the material can result in breakages.

### SURFACE APPEARANCE

Check every single slab. The slabs are obtained by processing raw materials of a natural origin. The visual inspection must be carried out from a distance of 80 cm, positioned perpendicular to the surface and in natural light.

Slight flaws are deemed acceptable within the following limits:

- Spots (colour spots which are unrelated to the tile pattern and strongly contrasting with the background): up to 1 mm.
- Lumps on surface (slight colour contrast with the background): up to 3 mm in diameter and 1 mm thick with respect to the background.
- Black pinpoints up to 1mm in diameter are allowed.
- The concentration of spots of contrasting colour with a diameter of less than one millimetre is limited to 6 per square decimetre.
- For claims concerning flaws due to a lack of printing, there must be a continuous line on the material in order to be accepted. The visual inspection must be carried out from a distance of 80 cm, positioned perpendicular to the surface and in natural light.

### INSTALLATION

To enhance the characteristics of the product during installation, a basic precaution for laying our material is to carefully alternate the different shades by taking the material in groups of 3-4 tiles at a time from at least five different boxes. Spread the various clearly different colour shades evenly and check the result from time to time, inspecting an area of the laid material from a suitable distance.

For the installation of straightened-edge materials, it is always essential to maintain a minimum joint of 2/3 mm from one tile to another, using grouts and sealants in a colour which coordinates with the material. When laying rectangular straightened-edged materials, it is important to lay the tiles staggered but not in line with the centre of the tile, as this will offset any flatness flaws in any oversize tiles.

Since the material is cut or ground to a straight-edge, to prevent this problem occurring, it is advisable to lay the material staggered by 6 to 10 cm, depending on the length. It is highly advisable to have the tiles laid by a professional tiler who, after checking that the concrete bed is flat, will ensure the material is laid to perfection.

Finally, we suggest you use the R.L.S. (Raimondi Levelling System) when laying, concerning which you should note the following.

The R.L.S. system has revolutionised the world of tile laying, guaranteeing perfectly levelled floors as well as quick and easy laying, and no more uneven tiling. The R.L.S. system is perfect for oversize tiles, in particular for long, narrow sizes.

The R.L.S. is a three-part system, comprising; a base, a wedge, and a clamp. The bases are available in two different versions; for tiles with a thickness of between 3 and 12 mm; for tiles with a thickness of between 12 and 20 mm.

The wedge is the only part that is used for both bases and can be reused over again. The adjustable clamp is available in one version for laying on the floor and a different version for laying on a wall and is recommended to allow easy insertion of the wedges into the bases, while optimising the pressure exerted on the tile. The clamp is the same, regardless of the tile thickness.

### DIFFERENCES IN TILE COLOUR

The colour shading difference index is a means of rating the difference in colour tone from one tile to another. The reference value for each series is shown in the catalogue (V1 even shading - V4 different shading and patterns). The catalogue also clearly states that the colour of the tiles in the pictures is provided for illustrative purposes only and that these tones normally vary from one batch to another. This means that receipt

of a colour tone which differs from the sample cannot be considered grounds for complaint.

The classic example is that of a difference in colour with respect to the relative sample chosen in the shop.

### CLAIMS CONCERNING OBVIOUS DEFECTS

Defects are divided into obvious defects, i.e. flaws that are clearly and immediately visible, and hidden defects, i.e. flaws that appear over time. In the case of tiles, it should be noted that obvious defects are those which are visible prior to laying and hidden defects are those that become noticeable after laying and are not necessarily attributable to the tiles but could be caused by other factors.

As stated above and as highlighted on the packaging, before laying the material it is important to check that the material is compliant. According to standard UNI 10545-1, in order to be considered compliant, at least 95% of the tiles supplied must have no defects. Claims based on this right can only be made if the material has not been laid, as laying renders them worthless.

Obvious defects include the following:

- Flaws in the pattern
- Flaws in the surface (scratches, lumps, black pinpoints, surface finish)
- Variations in colour (according to UNI 11493, the tiler must ensure good lighting during laying so as to be able to check that the laying is proceeding correctly; poor lighting cannot, therefore, be used as a justification)
- Dimensional defects (length, flatness, curvature in the centre,...)
- According to UNI 11493/2016: MINIMUM OBSERVATION DISTANCE First and foremost, in paragraph 5.2.2, the said standard specifies that the visual inspection must be carried out from a minimum distance of 1,5 m (i.e. inspecting the flooring from a standing position or the wall tiles from a distance, so, neither lying on the floor nor standing up close to the wall).
- According to UNI 11493/2016: VISUAL INSPECTIONS IN OBLIQUE LIGHT ARE NOT ALLOWED Secondly, again in the same paragraph, the standard establishes that the floor or wall tiling being inspected cannot be lit using oblique light.

This is because oblique light highlights even the slightest unevenness in the tile or the laying.

After laying, rather than the manufacturer, the tiler or the contractor is liable for these defects.

### IT

### RICEVIMENTO MERCE

- Controllare la corrispondenza tra documento di trasporto, ordine e quanto ricevuto.
- Verificare l'integrità esterna dell'imballo (assenza di urti o deterioramenti visibili).
- Aprire l'imballo controllando almeno la prima lastra (tono, aspetto, scelta, calibro), oltre a verificare lo stato del materiale (la movimentazione delle lastre deve avvenire secondo indicazioni fornite).
- Si ricorda che il materiale posato non può più essere contestato per non conformità di aspetto o per diffeologia evidente.

### MOVIMENTAZIONE

Urti importanti e accidentali possono provocare la rottura del materiale. Più lastre possono essere stoccate e movimentate sovrapposte solo se di pari dimensioni. Evitare che la lastra (o parte di essa) venga posizionata su tagli o sfridi di dimensione inferiore e verificare sempre che l'appoggio sia privo di vuoti o spazi. Evitare di posizionare altri materiali sulle lastre. Prendere attenzione in ogni fase di movimentazione, al fine di evitare urti che possano provocarsi sboccature e/o rotture delle lastre. Anche la presa della singola lastra va eseguita con precauzione, posizionando la pinza centralmente e nei limiti di peso indicati dal macchinario. Per le prese multiple mediante sollevatore a bilancino, utilizzare scrupolosamente la cinghia in tela, opportunamente rivestita con gomma anti-taglio, posizionando le lastre con le dovute distanze e precauzioni. Si consiglia di inserire sul fondo e sulla parte superiore un distanziale in legno, con dimensioni superiori al pacchetto di lastre sulle quale appoggiare le cinghie affinché il peso e la tensione non gravino direttamente sulle lastre. Non utilizzare cavi di acciaio o catene che possano rovinare la superficie e i bordi.

I pezzi ottenuti dalla lavorazione possono risultare taglienti e devono pertanto essere maneggiati con cura e protezioni adeguate. La movimentazione dei singoli elementi (anche quelli privi di forature) deve avvenire sempre di costa. Il materiale tagliato deve essere imballato in casse dotate di protezione degli spigoli e pannelli ammortizzanti nelle parti perimetrali (con spessori adeguati) per preservarlo in caso di urto.

Il confezionamento non idoneo del prodotto può provocarne la rottura.

### ASPETTO SUPERFICIALE

Controllare ogni singola lastra. Le lastre sono ottenute per lavorazione di materie prime di origine naturale. L'osservazione va fatta alla distanza di 80 cm, perpendicolarmente alla superficie e con luce naturale.

Piccole imperfezioni sono considerate accettabili con i seguenti limiti:

- Inquinamento (punti di colore estranei alla grafica a forte contrasto di colore con il fondo): fino a 1 mm.
- Grumi a rilievo (basso contrasto di colore con il fondo): fino a 3 mm di diametro e 1 mm di spessore rispetto al fondo.
- Sono ammessi punti neri fino ad 1 mm di diametro.
- La concentrazione di punti a contrasto di colore con diametro inferiore al millimetro è limitata a 6 per decimetro quadrato.
- La contestazione per imperfezione dovuta ad una mancanza di stampa, per essere accettata deve presentare una riga continua. L'osservazione va fatta alla distanza di 80 cm, perpendicolare alla superficie e con luce naturale.

### POSA

Per valorizzare le caratteristiche del prodotto in fase di posa, un accorgimento basilare per la posa del nostro prodotto è quello di alternare con cura le differenti tonalità prelevando le piastrelle a gruppi di 3-4 pezzi per volta da almeno cinque scatole diverse. Distribuire in modo armonioso le diverse sfumature di colore che si evidenziano e controllare il risultato di tanto in tanto, osservando da opportuna distanza una porzione di lavoro eseguita.

Per la posa di materiali rettificati è sempre indispensabile mantenere una fuga minima di 2/3 mm da una piastrella all'altra usufruendo di stucchi e sigillanti di colore coordinato a quello del materiale. Nella posa dei materiali rettificati rettangolari, è importante evitare di far collimare i vertici di una piastrella con la meta delle altre al fine di sopprimere alle eventuali imperfezioni di planarità presenti comunque in tutti i grandi formati. Trattandosi di materiale tagliato o rettificato, per evitare tale problema, è consigliabile posare il materiale a correre, con intervallo da 6 a 10 cm a seconda della lunghezza. È fortemente auspicabile affidare la posa a personale esperto che, dopo aver verificato la corretta planarità della caldina, contribuirà alla impeccabile esecuzione dell'incarico. Suggeriamo infine di adattarsi al sistema di posa R.L.S. (Raimondi Levelling System) per il quale vi forniamo le seguenti indicazioni.

Il sistema R.L.S. rivoluziona il mondo della posa garantendo di ottenere con semplicità e rapidità pavimenti perfettamente livellati eliminando i dislivelli tra le piastrelle. R.L.S. è perfetto per grandi formati e in particolare per formati stretti e lunghi.

R.L.S. è composto di 3 elementi: base, cuneo, pinza. Le basi sono disponibili in due diverse versioni: per piastrelle di spessore compreso tra i 3 e i 12mm; le piastrelle di spessore compreso tra i 12 e 20 mm. Il cuneo è l'unico per entrambi le basi ed è riutilizzabile infinite volte. La pinza regolabile è disponibile in versione per posa a pavimento e in versione per posa a rivestimento ed è consigliata per inserire con facilità i cunei nelle basi, ottimizzando al contempo la pressione esercitata sulla piastrella. La pinza è unica indipendentemente dallo spessore della piastrella.

### DIFFORMITÀ DEL COLORE DELLE PIASTRELLE

L'indice di stonalizzazione è la classificazione della diversità di tono di colore da una piastrella all'altra. Il valore di riferimento per ogni serie è riportato su catalogo (V1 colore uniforme – V4 colore e grafiche diverse). Nel catalogo inoltre è specificato che il tono delle piastrelle è puramente indicativo e che normalmente varia da lotto a lotto. Questo significa che non può essere motivo di contestazione l'aver ricevuto un tono diverso dal campione.

Il classico esempio è quello della difformità di colore rispetto al campione di riferimento scelto nel negozio.

### CONTESTAZIONI PER VIZI PALESI

I vizi si distinguono in palesi, vale a dire immediatamente percepibili, ed occulti, vale a dire che si manifestano nel tempo. Nel caso delle piastrelle si può dire che i vizi palesi sono quelli che si possono evidenziare prima della posa e che i vizi occulti sono quelli che si evidenziano dopo la posa e che possono anche non essere imputati alle piastrelle ma ad altri componenti. Come specificato nei punti precedenti e come indicato sugli imballi, prima di posare il materiale bisogna controllare che il materiale sia conforme. La norma UNI 10545-1 dice che, la fornitura per ritenersi conforme deve presentare almeno il 95% di piastrella senza difetti. Si può rivalere di questo diritto solo se il materiale non è stato posato, caso decadenza valore.

Per vizi palesi si indicano:

- Difetti grafici
- Difetti superficiali (graffi, grumi, punti neri, superficie)
- Variazioni toni (La norma UNI 11493 riporta che il posatore deve mettersi nelle migliori condizioni di luce per controllare il buon andamento della posa e quindi non si possono accampare motivazioni di scarsa illuminazione)
- Difetti dimensionali, (lunghezza, planarità, curvatura al centro, ...)
- Secondo la Norma Uni 11493/2016: DISTANZA MINIMA DELL'OSSERVATORE

Innanzitutto la norma stabilisce al paragrafo 5.2.2 che l'esame visivo si effettua ad una distanza minima di 1,5 metri (quindi osservando il pavimento stando in piedi o il rivestimento stando a distanza: non ci si sdraia a terra, né si esamina il rivestimento standoci attaccati).

• Secondo la Norma Uni 11493/2016, NON AMMESSO ESAME CON LUCE RADENTE
In secondo luogo, sempre allo stesso paragrafo la norma stabilisce che non si può illuminare il pavimento o il rivestimento oggetto di analisi con luce radente. La luce radente, infatti, evidenzia anche minime irregolarità della piastrella o della posa.

In seguito la posa tutti questi difetti non saranno più responsabilità del produttore ma del posatore o appaltatore.

### FR

### RÉCEPTION DES MARCHANDISES

- Contrôler la correspondance entre le document de transport, la commande et le matériel reçu.
- Vérifier l'intégrité externe de l'emballage (absence de traces de choc ou de détériorations visibles).
- Ouvrir l'emballage, en vérifiant au moins la première dalle (ton, aspect, choix, calibre), ainsi que l'état du matériau (les dalles doivent être manipulées selon les instructions fournies).
- On rappelle que le matériel posé ne peut plus être contesté pour aspect non conforme ou défaut évident.

### MANUTENTION

Des impacts majeurs et accidentels peuvent provoquer la cassure du matériau. Plusieurs dalles peuvent être stockées et manipulées en se chevauchant uniquement si elles sont de taille égale. Éviter que la dalle (ou une partie de celle-ci) soit positionnée sur des coupures ou des rebuts d'une dimension inférieure et toujours vérifier que le support est exempt de vides ou d'espaces. Éviter de positionner d'autres matériels

sur les dalles. Faire attention à chaque phase de la manutention, afin d'éviter les chocs susceptibles de provoquer un cisaillement et/ou une rupture des dalles. De même, la préhension d'une dalle à la fois doit être effectuée avec précaution, en positionnant la pince au centre et dans les limites de poids indiquées par la machine. Pour les préhensions multiples au moyen d'un élévateur à palonnier, utiliser scrupuleusement la sangle en toile, convenablement revêtue de caoutchouc anti-coupure, en positionnant les dalles à la bonne distance et avec les précautions appropriées. Il est conseillé d'insérer une entretoise en bois sur le fond et sur le dessus, de dimensions supérieures à l'ensemble du paquet des dalles sur lesquelles reposer les angles afin que les poids et la tension ne pésent pas directement sur les dalles. Ne pas utiliser de câbles en acier ou de chaînes qui pourraient endommager la surface et les bords. Les pièces usinées peuvent être tranchantes et doivent donc être manipulées avec soin et des protections adéquates. La manutention d'éléments individuels (même ceux sans trous) doit toujours être effectuée sur le côté. Le matériel coupé doit être emballé dans des boîtes équipées d'une protection des arêtes et de panneaux antichocs au niveau des parties périmétriques (avec des épaisseurs adéquates) pour le préserver en cas de choc. Un emballage inadéquat du produit peut entraîner une cassure.

### ASPECT DE LA SURFACE

Vérifier chaque dalle. Les dalles sont obtenues par la transformation de matières premières d'origine naturelle. L'observation doit être effectuée à une distance de 80 cm, perpendiculairement à la surface et en présence d'une lumière naturelle.

Les petites imperfections sont réputées acceptables dans les limites suivantes:

- Pollution (points de couleur étrangers présentant un fort contraste de couleur avec le fond) : jusqu'à 1 mm.
- Grumeau en relief (faible contraste de couleur avec le fond) : jusqu'à 3 mm de diamètre et 1 mm d'épaisseur par rapport au fond.
- Les points noirs d'un diamètre maximal de 1 mm sont admis.
- La concentration de points de contraste de couleur d'un diamètre inférieur à un millimètre est limitée à 6 par décimètre carré.
- Pour être acceptée, une contestation pour imperfection due à un défaut d'impression, doit comporter une ligne continue. L'observation doit être effectuée à une distance de 80 cm, perpendiculaire à la surface et en présence d'une lumière naturelle.

### POSE

Afin de valoriser les caractéristiques du produit lors de la pose, une précaution élémentaire consiste à alterner soigneusement les différentes teintes en prélevant les carreaux par groupes de 3-4 pièces à la fois dans au moins cinq boîtes différentes. Répartir les différentes nuances de couleur qui ressortent harmonieusement et vérifier de temps en temps le résultat en observant une partie du travail réalisé à une distance convenable.

Lors de la pose de matériel rectifié, il est toujours indispensable de maintenir un joint minimum de 2/3 mm d'un carreau à l'autre, en utilisant des joints et des mastics assortis à la couleur du matériel. Lors de la pose de matériel rectifié rectangulaire, il est important d'éviter que les sommets d'un carreau coïncident avec la moitié des autres carreaux afin de compenser d'éventuelles imperfections de planéité qui sont toujours présentes dans tous les grands formats. Étant donné qu'il s'agit de matériel coupé ou rectifié, pour éviter ce problème, il est conseillé de poser le matériel à coupe perdue, avec un intervalle de 6 à 10 cm selon la longueur. Il est hautement souhaitable de confier la pose à un personnel expert qui, après avoir vérifié la bonne planéité de la sous-couche isolante, contribuera à l'exécution sans faille de la tâche.

Enfin, nous suggérons de s'adapter au système de pose R.L.S. (Raimondi Levelling System) pour lequel nous fournissons les informations suivantes. Le système R.L.S. révolutionne le monde de la pose en garantissant l'obtention du carrelage parfaitement nivelé de manière simple et rapide, en éliminant les différences de niveau entre les carreaux. R.L.S. est parfait pour les grands formats et en particulier pour les formats étroits et longs.

R.L.S. se compose de 3 éléments : base, coin, pince. Les bases sont disponibles en deux versions différentes : pour les carreaux d'une épaisseur comprise entre 3 et 12 mm; pour les carreaux d'une épaisseur comprise entre 12 et 20 mm.

La cale est la seule pour les deux bases et elle est réutilisable à l'infini. La pince réglable, disponible dans les versions pour pose au sol et murale, est recommandée pour faciliter l'insertion des coins dans les bases tout en optimisant la pression exercée sur le carreau. La pince est unique indépendamment de l'épaisseur du carreau.

### DIFFÉRENCES DE COULEUR DES CARREAUX

L'indice de détonalisation est une classification de la différence de tonalité des couleurs d'un carreau à l'autre. La valeur de référence pour chaque série est indiquée dans le catalogue (V1 couleur uniforme - V4 différents graphismes et couleurs). Le catalogue indique également que la tonalité des carreaux est purement indicative et varie normalement d'un lot à l'autre. Cela signifie que la réception d'une tonalité différente de celle de l'échantillon ne peut constituer un motif de plainte. L'exemple classique est celui de l'écart de couleur par rapport à l'échantillon de référence choisi dans le magasin.

### CONTESTATIONS POUR DÉFAUTS MANIFESTES

On distingue les défauts manifestes, c'est-à-dire ceux qui sont immédiatement perceptibles, et les défauts cachés, c'est-à-dire ceux qui deviennent apparents avec le temps. Dans le cas des carreaux, on peut dire que les défauts manifestes sont ceux qui peuvent être détectés avant la pose et que les défauts cachés sont ceux qui interviennent après la pose et qui peuvent ne pas être attribuables aux carreaux, mais à d'autres composants.

Comme spécifié dans les points précédents et comme indiqué sur l'emballage, la conformité du matériel doit être vérifiée avant la pose. La norme UNI 10545-1 stipule que, pour être réputée conforme, la fourniture doit présenter au moins 95 % de carreaux sans défaut. Ce droit ne peut être exercé que si le matériel n'a pas été posé. Au contraire, le droit s'éteint.

Les défauts manifestent sont indiqués ci-après :

- Défauts graphiques
- Défauts de surface (rayures, grumeaux, points noirs, surface)
- Les variations de ton (La norme UNI 11493 stipule que l'installateur doit prévoir les meilleures conditions d'éclairage pour vérifier la bonne exécution de la pose, et donc aucune raison ne peut être invoquée pour un mauvais éclairage)
- Défauts dimensionnels, (longueur, planéité, courbure au centre, etc.)
- Selon la Norme Uni 11493/2016 : DISTANCE MINIMALE DE L'OBSERVATEUR Tout d'abord, la norme stipule au paragraphe 5.2.2 que l'examen visuel doit être effectué à une distance minimale de 1,5 mètre (c'est-à-dire en observant le sol en étant debout ou le revêtement mural en étant debout à distance: on ne se couche pas sur le sol ou et on n'examine pas le revêtement en étant contre celui-ci).
- Selon la norme Uni 11493/2016; EXAMEN AVEC LUMIÈRE RADIANTE NON AUTORISÉE Ensuite, toujours dans le même paragraphe, la norme indique que le revêtement de sol ou mural analysé ne peut pas être éclairé par une lumière rasante.

En effet, la lumière rasante met en évidence les moindres irrégularités du carreau ou de la pose.

Après l'installation, tous ces défauts ne seront plus de la responsabilité du fabricant, mais du poseur ou de l'entrepreneur.

### D

### WARENEINGANG

Gleichen Sie den Lieferschein und Transportpapiere beim Wareneingang mit der Bestellung ab.

Überprüfen Sie die Verpackung auf sichtbare Beschädigung.

Öffnen Sie die Verpackung und überprüfen Sie mindestens die erste Platte auf deren Zustand auf Ton, Aussehen, Wahl und Kaliber. (Die Handhabung der Platten muss nach den angegebenen Hinweisen erfolgen).

Beachten Sie, dass verlegtes Material nicht mehr aufgrund optischer Abweichung oder offensichtlicher Mangel reklamiert werden kann.

### HANDHABUNG

Größere, auch unbeabsichtigte Stöße können zum Bruch des Materials führen. Mehrere Platten können nur übereinander gelagert werden, wenn sie die gleiche Größe haben. Vermeiden Sie, dass die Platte (oder ein Teil davon) auf Schnitte oder Abschnitte kleinerer Größe gelegt wird und überprüfen Sie immer, dass die Unterlage frei von Hohlräumen oder Zwischenräumen ist. Vermeiden Sie es, andere Materialien auf die Platten zu legen.

Vermeiden Sie Kollisionen in jeder Handhabungsphase, die zum Abplatzen und / oder Brechen der Platten führen können. Auch das Greifen der einzelnen Platten muss sorgfältig erfolgen, wobei der Greifer mittig und innerhalb der von der Maschine angegebenen Gewichtsgrenzen positioniert wird.

Verwenden Sie bei Sauggreifer geeignete Gewebespanngurte und positionieren Sie die Platten mit den erforderlichen Abständen und Vorsichtsmaßnahmen.

Es wird empfohlen, unten und oben einen hölzernen Abstandshalter einzulegen, der größer als das Plattenpaket ist, auf dem die Riemen platziert werden sollen, damit das Gewicht und die Spannung nicht direkt auf die Platten einwirken. Keine Stahlselle oder Ketten verwenden, die die Oberfläche und Kanten beschädigen können. Die bei der Verarbeitung anfallenden Stücke können scharfkantig sein und müssen daher mit Vorsicht und ausreichendem Schutz behandelt werden. Die Handhabung der Einzelelemente (auch ohne Löcher) muss immer senkrecht erfolgen. Das geschnittene Material muss in Kisten verpackt werden, die mit Kantenschutz und stoßdämpfenden Platten in den Randbereichen (mit ausreichender Dicke) ausgestattet sind, um es im Falle einer Kollision zu bewahren.

Eine unsachgemäße Verpackung des Produkts kann zu Bruch führen.

### OVERFLÄCHENPRÜFUNG

Überprüfen Sie jede einzelne Platte!

Die Platten werden durch die Verwendung natürlicher Rohstoffe produziert und so muss vor Verlegung eine Sichtprüfung in einem Abstand von 80 cm, senkrecht zur Oberfläche und mit natürlichem Licht vorgenommen werden.

Kleine Unvollkommenheiten werden mit den folgenden Einschränkungen als akzeptabel betrachtet:

- Verschmutzung (Farbpunkte ohne Bezug zur Grafik mit starkem Farbkontrast zum Hintergrund): bis zu 1 mm².
- Reliefpickel (geringer Farbkontrast zum Hintergrund): bis zu 3 mm Durchmesser und 1 mm Dicke im Vergleich zum Boden.
- Schwarze Punkte bis 1 mm Durchmesser sind erlaubt.
- Die Konzentration kontrastierender Farbpunkte mit einem Durchmesser von weniger als einem Millimeter ist auf 6 Stck. pro Quadratdezimeter begrenzt.
- Ein Einwand wegen Unvollkommenheit aufgrund fehlenden Drucks, oder einer durchgezogenen Linie muss anhand Fotos gemeldet werden. Die Sichtung muss in einem Abstand von 80 cm senkrecht zur Oberfläche und bei natürlichem Licht erfolgen.

### VERLEGUNG

Um die Eigenschaften des Produkts während der Installationsphase zu verbessern, sind grundlegende Vorsichtsmaßnahme für die Installation zu beachten:

Die Platten bestehen aus verschiedenen Farbtöne, die möglichst aus fünf verschiedenen Kartons abzuwechseln bzw. zu kombinieren sind. Verteilen Sie die einzelnen Platten zu einer harmonischen Gesamtbild und vermeiden Sie abweichende Farbton innerhalb einer Fläche.

Bei der Installation von rektifizierten Materialien ist es unerlässlich einige Mindestfuge von 2/3 mm zwischen den Platten einzuhalten und geeignete, farblich abgestimmte Fugenmörtel und Dichtstoffe zu verwenden. Beim Verlegen von rechteckigen rektifizierten Materialien ist es wichtig den Scheitelpunkt einer Platte nicht in die Hälfte der zwei anschließenden Platten zu stoßen um eventl. entstehende Ebenheitsunterschiede zu kompensieren.

Da das Material geschnitten oder geschliffen wird, ist es ratsam das Material in einem Versatz von maximal 6-10cm zu verlegen. Generell sollte Fachpersonal mit der Verlegung von Großformaten beauftrag werden.

Schließlich empfehlen wir , z.B. das R.L.S. (Raimondi Leveling System) zu verwenden.

Die R.L.S. revolutioniert die Welt des Verlegens, garantiert einfach und schnell, perfekt nivellierte Böden und beseitigt Unebenheiten zwischen den Fliesen.

R.L.S. es perfekt für große Formate, im besonderen für schmale und lange Formate.

R.L.S. besteht aus 3 Elementen: Basis, Keil, Klemme. Das Basiselement ist in zwei verschiedenen Ausführungen erhältlich: für Fliesen mit einer Dicke zwischen 3 und 12 mm; sowie Fliesen mit einer Dicke zwischen 12 und 20 mm.

Der Keil ist der einzige für beide Basiselemente und kann immer wieder verwendet werden.

Ein verstellbarer Greifer ist für die Verlegung auf dem Boden und in einer Version für die Verlegung an der Wand verfügbar und wird empfohlen.

### FARBUNTERSCHIEDE

Der Farbtonindex ist die Klassifizierung der Farbtonvielfalt von einer Fliese zur anderen.

Der Referenzwert für jede Serie ist im Katalog angegeben (V1 einheitliche Farbe - V4 Farbe und Grafik sehr unterschiedlich). Der Katalog gibt auch an, dass der Ton der Fliesen rein inkativ ist und normalerweise von Produktion zu Produktion variieren kann. Dies bedeutet, dass ein vom Sample abweichender Ton kein Grund zur Beanstandung sein kann. Das klassische Beispiel ist der Farbutonschied zum im Shop gewählten, bzw. beispielhaften Referenzmuster.

### ANSPRUCH AUF FEHLERFREIHEIT

Mängel werden unterschieden in offensichtlich, d. h. sofort wahrnehmbar, und versteckt, d. h. erst im Laufe der Zeit erkennbar. Bei Fliesen ist davon auszugehen, dass sich eventuelle Mängel offensichtlich darstellen und bereits vor der Installation erkennbar sind. Versteckte Mängel sind diejenigen, die nach der Installation hervortreten, wobei diese in der Regel nicht der Fliese, sondern anderen Komponenten zuzuordnen sind. Wie in den vorherigen Punkten und wie auf der Verpackung angegeben, ist vor dem Verlegen des Materials zu überprüfen, ob das Material der Norm Uni 10545-1entspricht, die besagt, dass mindestens 95 % der Fliese fehlerfrei sein müssen.

Ein Rückgaberecht entsteht nur, wenn das Material nicht eingebaut wurde, weil sonst nicht mehr brauchbar.

Bei offensichtlichen Mängeln werden folgende Angaben gemacht:

- Grafikfehler
- Oberflächenfehler (Kratzer, Pickel, Einschüsse)
- Stonvariationen (Die Norm Uni 11493 besagt, dass sich der Installateur in die besten Bedingungen, wie geeignete Lichtverhältnisse zur unabhängigen Prüfung der Installation, versetzen muss. (Daher können keine Beanstandungen aufgrund schlechtem Licht gestellt werden)
- Maßfehler (Länge, Ebenheit, Krümmung in der Mitte, ...)
- Gemäß der Norm Uni 11493/2016: MINDESTABSTAND DES BEOBACHTERS Zunächst legt die Norm in Absatz 5.2.2 fest, dass die Sichtprüfung in einem geeigneten Mindestabstand durchgeführt wird. Im Bodenbereich sind 1,5 Meter Abstand einzuhalten um den Belag zu sichten. In geringerem Abstand zu erkennende Mängel sind nicht Beanstandungsfähig.
- Gemäß der Norm Uni 11493/2016; NICHT ZUGELASSENE UNTERSUCHUNG MIT STREIFLICHT Die Norm legt fest, dass der Boden oder die Beschichtung nicht unter Streiflicht analysiert werden darf, da Streiflicht sogar minimale, unvermeidliche Unregelmäßigkeiten hervorhebt.

Für alle diese Mängel ist nach der Installation nicht mehr der Hersteller verantwortlich, sondern der Installateur oder Auftragnehmer.

### General

### index

### Product indexes

### The Company

### Collections

### TH2.0

### Outdoor Solutions

### Bathroom furniture

Marketing coordination: Energieker  
Graphic design: Exprimio  
March 2025

Gold Art Ceramica S.p.a.  
Via Giardini Nord 231/233  
41026 Pavullo nel Frignano (MO), Italy

Tel. +39 0536 301711  
E-mail: energieker@energieker.it

[www.energieker.it](http://www.energieker.it)

**Colours depicted in this catalogue shall be purely indicative and could vary.**  
I colori rappresentati su questo catalogo sono puramente indicativi e possono subire variazioni.  
Les couleurs reproduites sur ce catalogue sont à considérer purement indicatives et ils peuvent  
subir de variations, car ils ne peuvent pas être représentés fidèlement sur papier imprimé.  
Die Farben in diesem Katalog sind rein indikativ und können Änderungen untergehen.

**Reproduction of this printed catalogue totally or partially, is forbidden.**  
È vietata la riproduzione, totale e parziale del catalogo in tutte le sue forme.

# Price codes

Codici prezzo . Codes prix . Preisschlüssel.

Euro		Euro		Euro		Euro		Euro	
Price code Codice prezzo	Gross price Prezzo lordo	Price code Codice prezzo	Gross price Prezzo lordo	Price code Codice prezzo	Gross price Prezzo lordo	Price code Codice prezzo	Gross price Prezzo lordo	Price code Codice prezzo	Gross price Prezzo lordo
101	2,78	119	18,57	137	34,21	155	68,13	170	123,39
102	3,36	120	19,59	138	35,67	155 (20 mm)	71,64	171	127,19
103	4,82	121	20,47	139	37,43	156	71,35	172	126,61
104	6,29	122	21,20	140	38,89	156 (20 mm)	74,85	173	133,04
105	6,87	123	22,22	141	40,64	157	74,56	174	138,01
106	7,89	124	26,02	142	43,86	157 (20 mm)	78,07	175	136,26
107	9,21	125	26,90	143	45,61	158	77,78	176	139,47
108	9,50	126	24,42	144	47,08	159	80,99	177	142,69
109	11,70	127	28,65	145	48,83	160	84,50	178	149,12
110	12,72	128	26,02	146	50,29	161	85,96	179	155,85
111	13,01	129	26,32	147	52,05	162	87,72	180	162,28
112	13,30	130	30,12	148	53,51	163	90,94	181	185,09
113	14,04	131	30,99	149	55,26	164	94,15	182	190,06
114	14,33	132	28,36	150	56,73	165	100,88	183	201,17
115	14,62	133	28,65	151	61,99	166	107,02	184	211,11
116	16,81	134	32,46	152	61,70	167	111,99	185	215,79
117	16,23	135	33,04	153	64,91	168	113,45	186	227,19
118	17,98	136	33,63	154	66,67	169	116,67	187	235,09

M<sup>2</sup> - Price per square metre. Prezzo al metro quadro. Prix du mètre carré. Preis pro Quadratmeter.

PC - Price for 1 piece. Prezzo al pezzo. Prix par unité. Preis pro Stück.

## Logistic service

Servizi di logistica. Service de logistique. Logistikdienstleistungen.

### SPLIT PALLET ORDERS:

Orders related to 9mm thickness goods with quantity below the pallet will be charged with an additional 2,00€/sqm. Orders containing 120x120, 120x270, 160x320 sizes either in 6 or 12 mm, as well as all TH2.0 range, will be charged with an additional 10%.

### SMALL QUANTITY ORDERS:

Orders with a rateable value under 100€ will be charged with a handling and packing fee equal to 30€.

### CANCELLATION OF ALREADY DISPATCHED ORDERS / RETURNS:

In case of cancellations (within a maximum of 30 days) of orders which have been already delivered to our Maranello warehouse or in case of authorized return (provided goods received by the customer are returned in good condition), the factory will charge an additional 15% of the order taxable amount, with a minimal value of 50€, as a contribution for the transport and take back expenses.

### SPALLETTIZZATO:

Per ordini inferiori al pallet completo verrà applicata una maggiorazione di 2,00€/M<sup>2</sup> a tutti i formati con spessore 9 mm fino al 60x120 incluso. Per i formati 120x120, 120x270, 160x320 con spessore 6/12 mm e per la gamma TH2.0 la maggiorazione è del 10%.

### ORDINI DI PICCOLE QUANTITÀ:

Per ordini di valore imponibile inferiore ai 100€ verrà applicato un costo di movimentazione e imballaggio di 30€.

### ANNULLAMENTO ORDINI GIÀ SPEDITI / RESO:

In caso di annullamento autorizzato (entro max 30 giorni) di ordini per materiale già consegnato al nostro deposito di Maranello o di reso autorizzato di materiale già ricevuto dal cliente (in buono stato), verrà addebitato il 15% del valore imponibile con importo minimo di 50€, per contributo spese di trasporto e ripresa in carico.

### CONTREMARQUE:

Pour les commandes inférieures à une palette complète, un supplément de 2,00 €/m<sup>2</sup> sera appliqué sur les prix nets « palettes et plus » pour tous les formats d'épaisseur 9 mm jusqu'au 60x120 inclus. Pour les formats 120x120, 120x270, 160x320 6mm/12mm et pour la gamme TH2.0 la majoration est de 10%.

### COMMANDES DE PETITES QUANTITÉS:

Pour toutes les commandes d'une valeur imposable inférieure à 100€, nous appliquerons des frais de manutention et d'emballage de 30€.

### POLITIQUE D'ANNULATION DE COMMANDES DÉJÀ EXPÉDIÉES/ POLITIQUE DE RETOUR:

Toute annulations ou retours doivent être autorisés par l'entreprise. Le client a 30 jours à disposition pour soumettre la demande. En cas d'annulation autorisée d'une commande de matériel déjà livré à notre entrepôt de Maranello ou d'un retour autorisé de matériel déjà reçu par le client (à condition qu'il soit en bon état), nous débiteons au client un 15% de la valeur imposable. Dans le cas où le 15% soit inférieur à 50€, nous débiteons toutefois un forfait de 50€ à titre de participation aux frais de transport et de reprise.

### KOMMISSIONIERUNG:

Bei Bestellungen unter einer vollen Palette wird ein Zuschlag von €2,00/m<sup>2</sup> auf alle 9 mm starken Formate bis einschließlich 60x120 erhoben. Für die Formate 120x120, 120x270, 160x320 6/12 mm und für die TH2.0-Reihe beträgt die Erhöhung 10 %.

### KLEINE MENGENBESTELLUNGEN:

Bei Bestellungen mit einer steuerpflichtigen Wert von weniger als 100 € werden Bearbeitungs- und Verpackungskosten von 30€ berechnet.

### STORNIERUNG BEREITS VERSANDTER/ZURÜCKGEBEBENER BESTELLUNGEN:

Im Falle einer autorisierten Stornierung (innerhalb von maximal 30 Tagen) von Bestellungen für bereits an unser Lager in Maranello geliefertes Material oder einer autorisierten Rückgabe von bereits vom Kunden erhaltenem Material (in gutem Zustand) werden 15% des steuerpflichtigen Wertes berechnet, wobei der Mindestsatz von 50 € für Transport- und Rücknahmekostenbeitrag beträgt.

General index

Product indexes

The Company

Collections

TH2.0 Outdoor Solutions

Bathroom furniture

Ventilated facades

Technical information



ENERGIEKER

[www.energieker.it](http://www.energieker.it)